

CAD Drawings

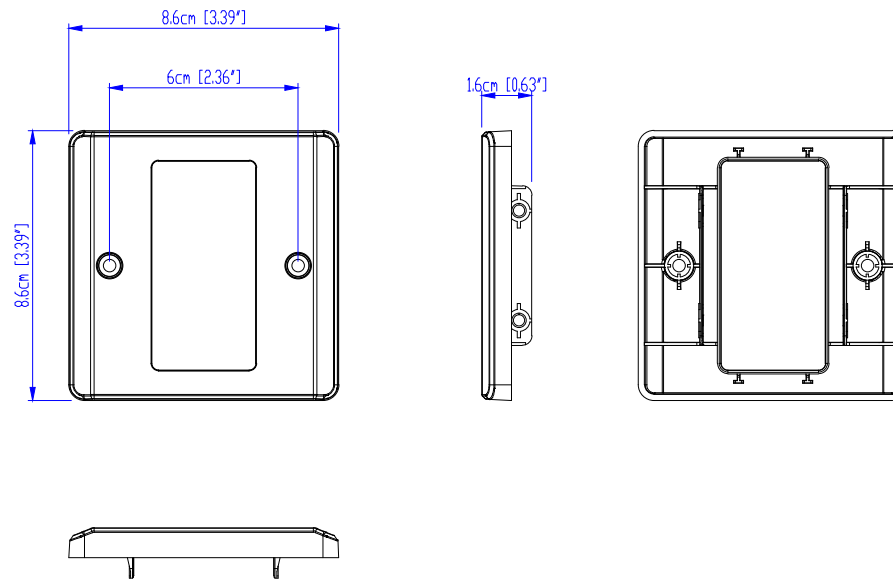

ATEN
VE1901AEUT

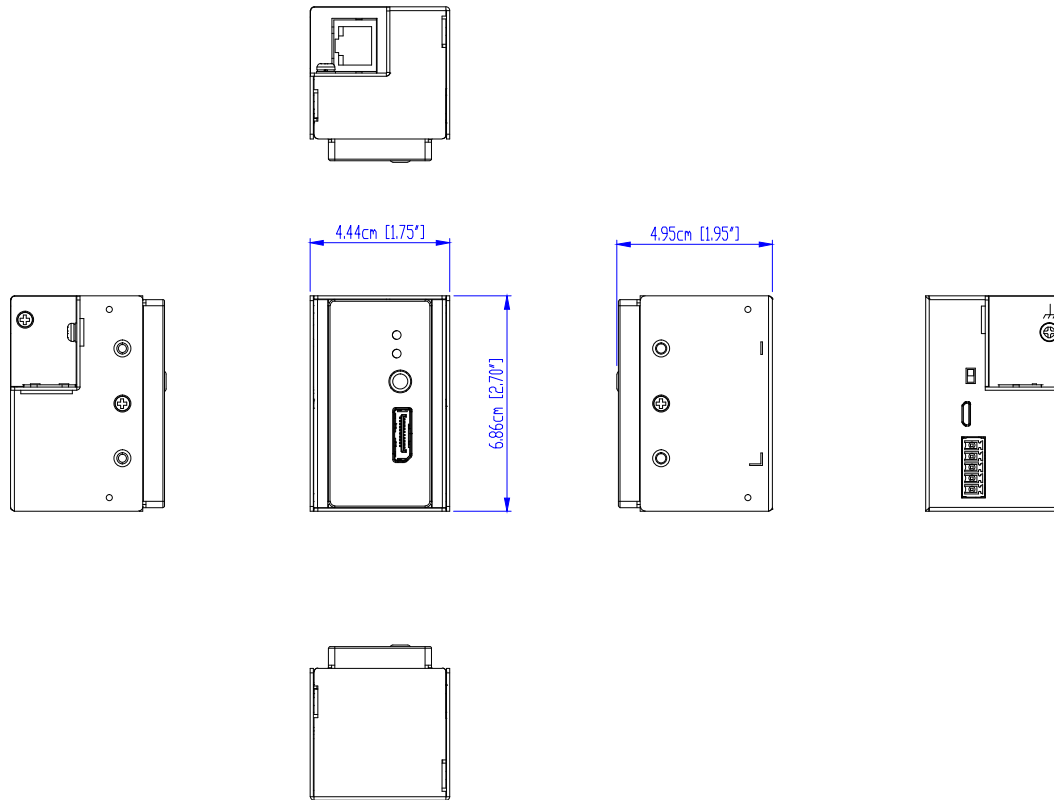

ATEN
VE1901AEUT

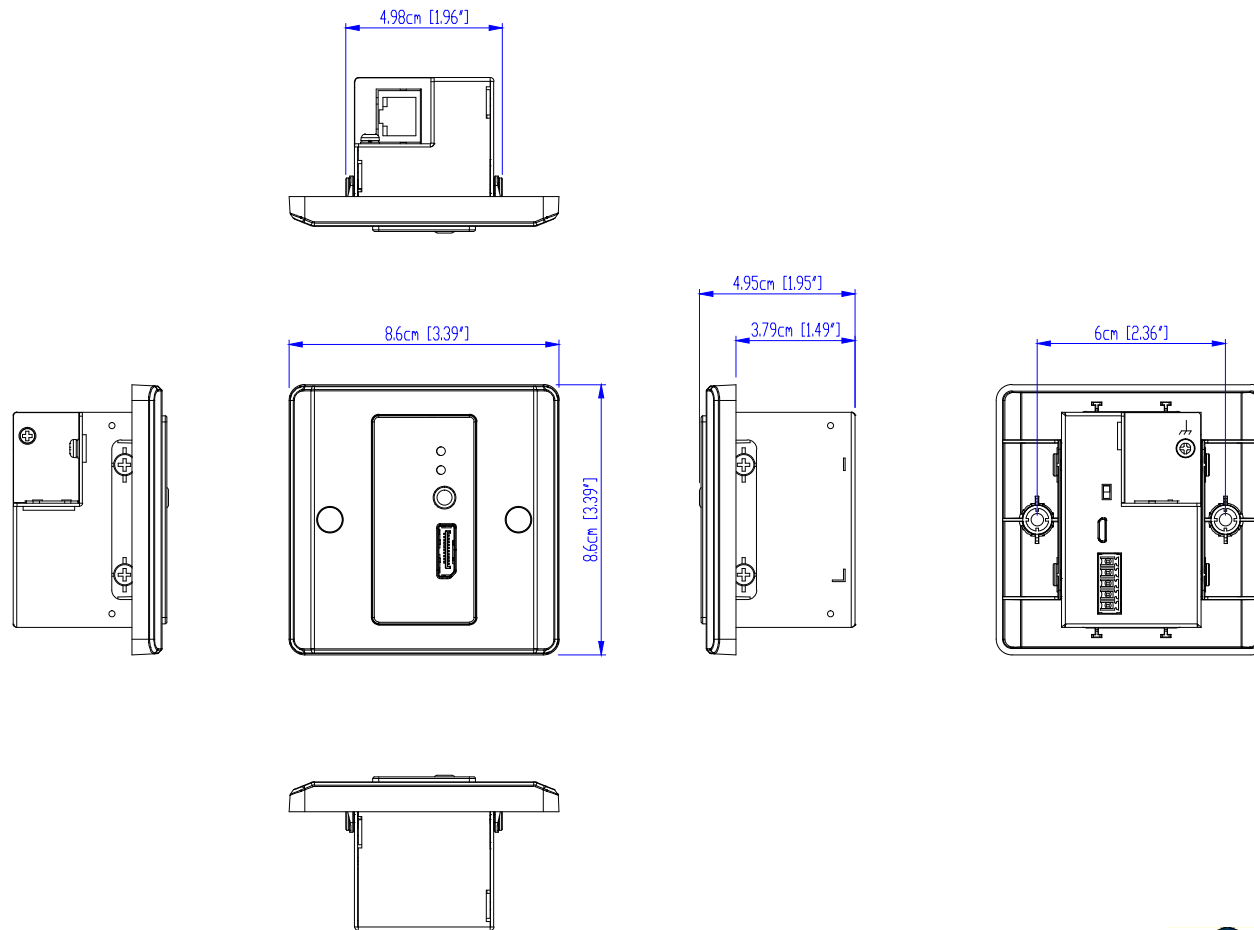

ATEN
VE1901AEUT

Panel Mount Cutout

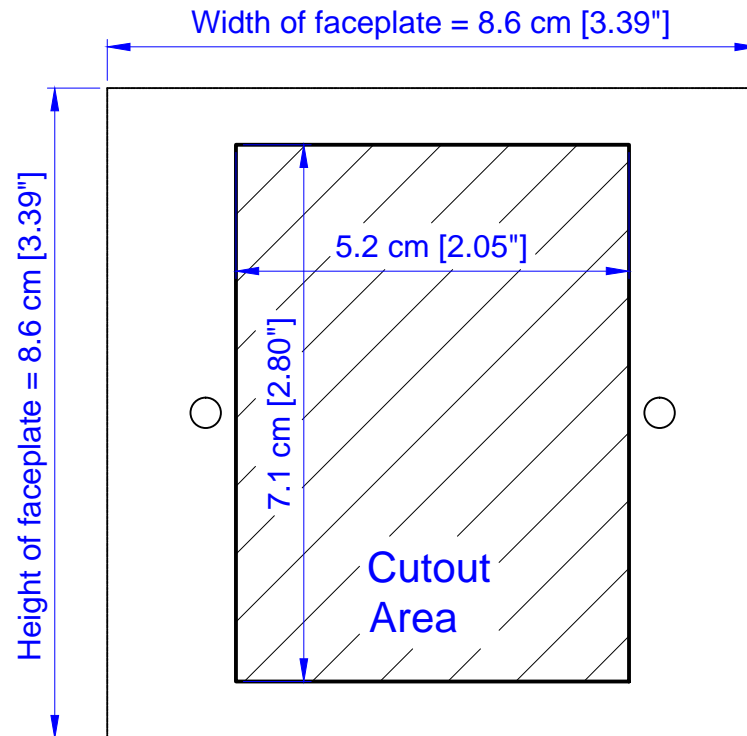

Note: ATEN recommends a 1-gang wall box with a depth of at least 4.5 cm (1.77 inches) to accommodate the connectors and cables.



VE1801AEUT
VE1901AEUT