



Pro Series / Digital Signage / Multibrackets®



Through strong partnerships with leading AV distributors, installers, and industry experts, we deliver digital signage solutions tailored to your business needs. Our focus is on creating simple, intuitive wall mounts and in-room installations that make setup effortless. With our Pro Series, we continually refine and expand our offering, helping your business reach a new level of digital signage excellence.

Engineered in Stockholm, Sweden.

Model name structure

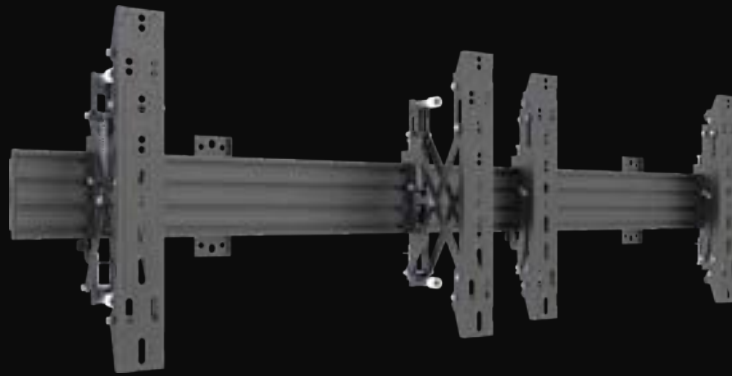

MB 2 X1U P

Multibrackets

2 rows

x1 units

Portrait



Truly
Modular design

Quick
Swift installation

Powerful
Rigorously tested

Experience
Sits in the details

Creativity
Empower creativity

Solutions
Vast possibilities

DIGITAL SIGNAGE - PRO SERIES

Introduction	6 - 11
Ceiling mounted solutions	12 - 39
Camera Ceiling Mounts	40 - 41
From Wall & Wall to Wall	42 - 43
Menu Boards	44 - 55
Floor to Ceiling.....	56 - 69
Floor to wall.....	70 - 73
The Wallmounts.....	74 - 107
Videowalls.....	108 - 113
Column.....	114 - 115
Outdoor Solutions.....	116 - 119
Collaboration.....	120 - 129
Floorstands.....	130 - 169
Wire.....	170 - 173
Monitor stands.....	174 - 179
Enclosures	180 - 195
LED.....	196 - 205
Customized.....	206 - 219
Control rooms.....	220 - 221
Monitor walls.....	222 - 223
Parts.....	224 - 239
Cable management.....	240 - 241

Digital Signage - Pro Series

A wide range of configurations

The Pro Series is a versatile digital signage system that can be configured as ceiling mounts, floor-to-ceiling mounts, menu boards, or wall mounts.

Thanks to its modular design, installers have the freedom to adapt, update, or completely reconfigure the setup as requirements evolve.

Over time, a single installation can be expanded or combined into an almost unlimited range of new configurations, ensuring maximum flexibility and long-term value.

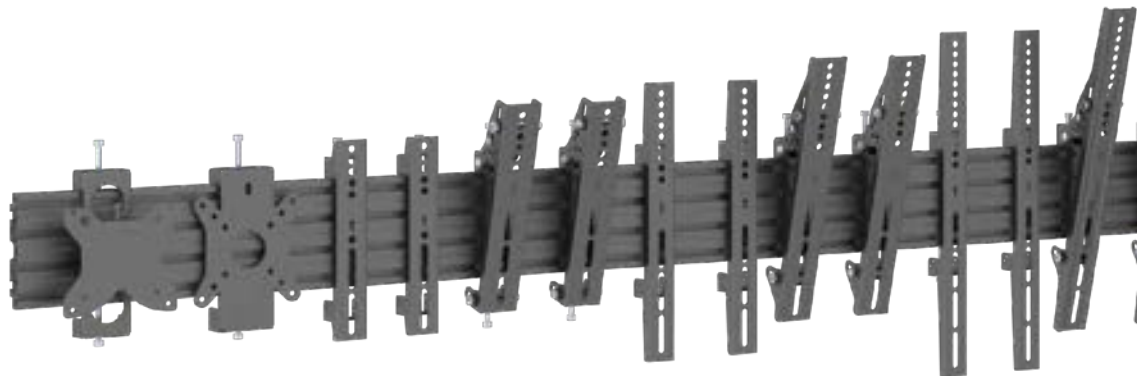

Precision leveling

Each mounting bracket includes micro-adjustment features, allowing precise height adjustments to ensure screens are perfectly level and aligned.

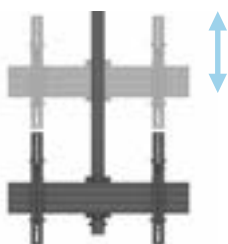

Extendable Height

The extendable poles allow the screen mounting plate to be positioned at virtually any height. For tighter spaces, a single-pole setup can achieve a minimum distance of just 80 cm.



Easy Tilt

The mounting brackets can be tilted forward by 5°, 10°, or 15° to optimize viewing angles while keeping screens perfectly aligned. To counteract potential forward lean, they can also be adjusted up to 6° backward.



Modular Design

Available in a wide range of models, our digital signage ceiling mounts support from a single display up to 18 screens, each weighing up to 30 kg. The modular construction allows additional extrusions to be added for wider VESA patterns or for connecting multiple units together, ensuring maximum flexibility for any installation.

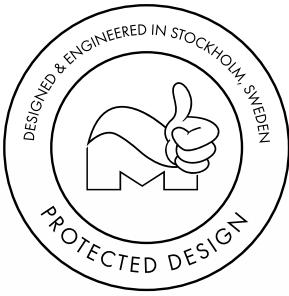

Selected models are
TUV approved

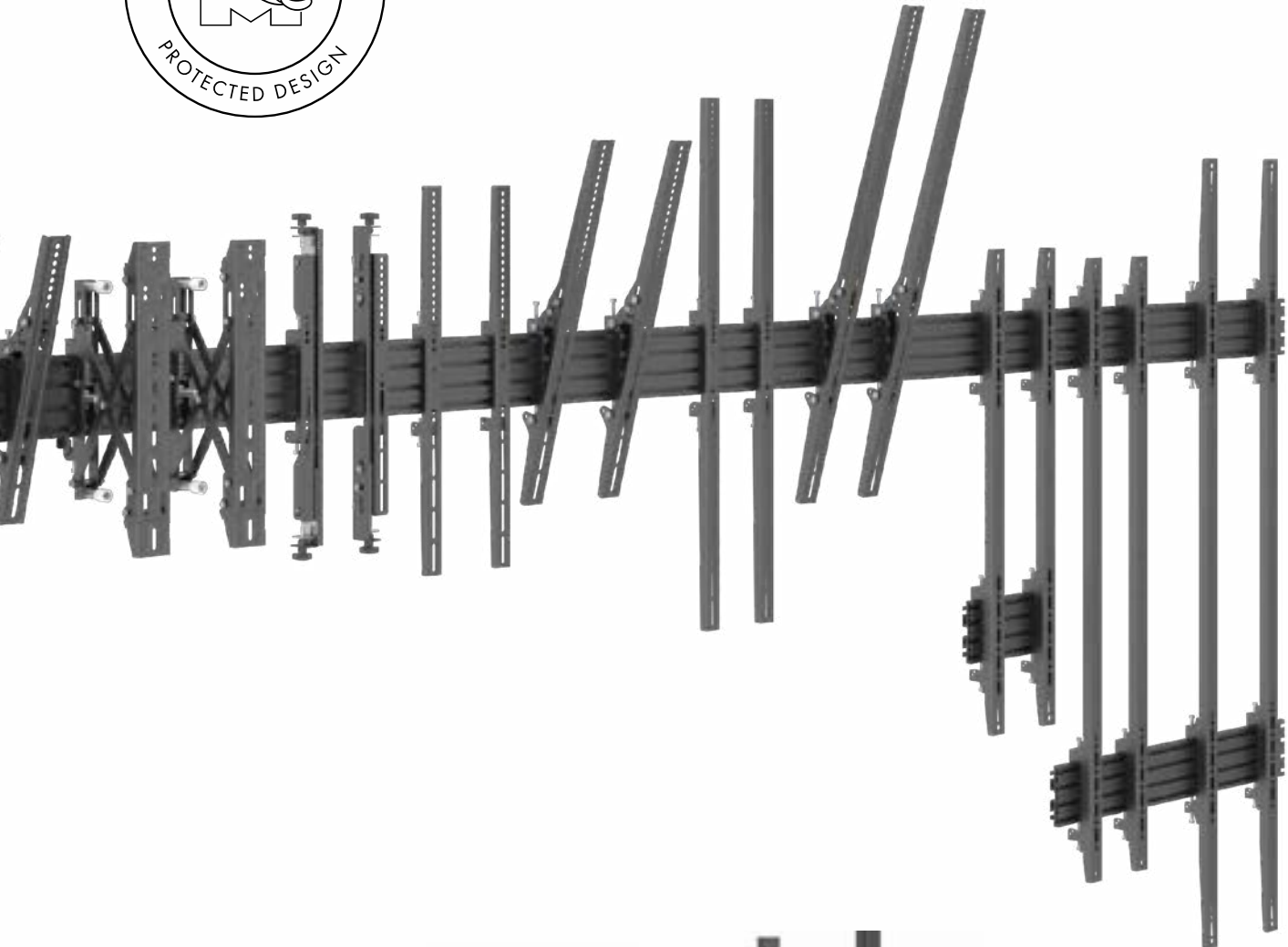

Cable Management

The extension pole's hollow core offers a clear path for routing cables, while an opening in the mounting plate lets them pass directly into the ceiling, ensuring a clean, professional installation.

Easy Installation

To minimize strain during setup, the ceiling plates are lightweight and installed separately from the rest of the mounting system. Once in place, simply slide in each extension pole and secure it, making installation fast, safe, and hassle-free.

Flexible floor mounting

The Pro Series is designed to support a wide range of freestanding solutions, wheeled, floor-standing, or securely bolted to the floor. Perfect for heavy-duty multi-screen installations, it combines robust functionality with a premium finish for an attractive, professional appearance.

Displays or LED panels

The Multibrackets Pro Series is a universal mounting system, compatible with LED panels, compatible with LED panels, and displays from leading brands like Samsung, LG, and Philips. Configurable in ceiling, wall, wheeled, freestanding, or floor-bolted formats, it's one of the market's most versatile solutions.

M Pro Series Rail System

Function and freedom for the installer

The Pro Series horizontal mounting rails form the backbone of every Pro Series solution — whether used in a wall-mounted menu board or a single-screen ceiling mount.

Crafted from high-grade aluminum, the rails are both strong and lightweight. They

are designed to support a wide range of interface arms and mounts, making it easy to attach monitors, displays, and other AV equipment.

Available in packaged lengths of 28 cm, 48 cm, 68 cm, 100 cm, 196 cm, and 348 cm, the rails can be mounted on Pro

Series columns, poles, or wall brackets. For maximum flexibility, they can also be cut to shorter lengths or extended by joining multiple sections together with extension kits, ensuring a perfect fit for any installation.

Modular design

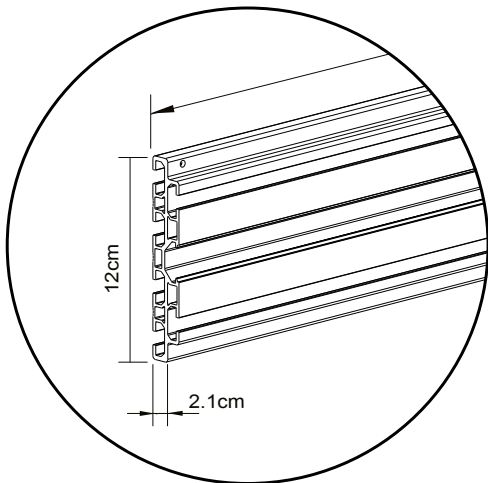
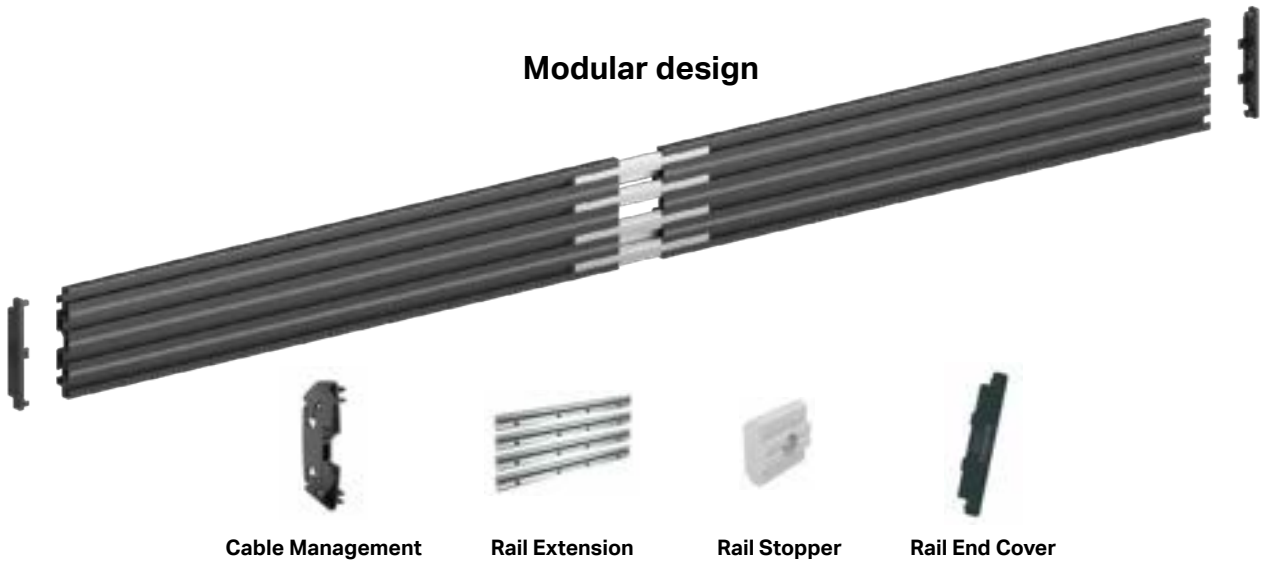

Micro adjustable

Micro adjustable	
	
M Pro Series Micro-Adjustable Arms 400mm	M Pro Series Micro-Adjustable Arms 600mm
735007373 3798	735010521 0457
Steel	Steel
5 kg (pcs)	3.5 + 4.3 kg (2 pcs)
543x49x47 mm	655x120x72 mm
30 kg / screen	30 kg / screen

Universal Interface Arms

Fixed



**M Pro Series
Fixed Arms 200mm**

EAN: 735007373 3903

Material: Steel

Weight: 1.5 kg (pcs)

Size: 230x35x33 mm



**M Pro Series
Fixed Arms 400mm**

EAN: 735007373 3736

Material: Steel

Weight: 2.2 kg (2pcs)

Size: 430x35x33 mm



**M Pro Series
Fixed Arms 600mm**

EAN: 735007373 3750

Material: Steel

Weight: 3 kg (2pcs)

Size: 630x35x33 mm



**M Pro Series
Fixed Arms 900mm**

EAN: 735007373 3774

Material: Steel

Weight: 5 kg (2pcs)

Size: 930x35x30 mm

NEW



**M Pro Series
Fixed Arms 1200mm**

EAN: 735010521 3922

Material: Aluminum

Weight: 8.5 kg

Size: 1260 x 90 x 70 mm

NEW



**M Pro Series
Fixed Arms 1600mm**

EAN: 735002273 3947

Material: Aluminum

Weight: 8.5 kg

Size: 1640 x 85 x 46 mm

Tilt



**M Pro Series
Tilt Arms 200mm**

EAN: 735007373 3910

Material: Steel

Weight: 3 kg (pcs)

Size: 230x68.5x39 mm

Max load: 30 kg / screen



**M Pro Series
Tilt Arms 400mm**

EAN: 735007373 3743

Material: Steel, aluminum

Weight: 3.5 kg (pcs)

Size: 430x68.5x39 mm

Max load: 30 kg / screen



**M Pro Series
Tilt Arms 600mm**

EAN: 735007373 3767

Material: Steel

Weight: 5 kg (2pcs)

Size: 630x68.5x39 mm

Max load: 30 kg / screen



**M Pro Series
Tilt Arms 900mm**

EAN: 735007373 3781

Material: Steel

Weight: 6.5 kg (2pcs)

Size: 930x68.5x39 mm

Max load: 30 kg / screen

Push in Pop out



**M Pro Series
M Push in Pop out
VESA 400**

EAN: 735007373 4726

Material: Steel

Weight: 3 kg (pcs)

Size: 230x68.5x39 mm

Max load: 30 kg / screen



**M Pro Series
M Push in Pop out Arms
600 mm**

EAN: 735010521 0464

Material: Steel, aluminum

Weight: 3.5 kg (pcs)

Size: 430x68.5x39 mm

Max load: 30 kg / screen

Monitor mounts

Fixed version



EAN: 735007373 6300

Tilt version



EAN: 735007373 6294

10mm height adj.

Rotation
360°

VESA
75x75,
100x100mm

Tilt -12° ~ +12°

Let us and our partners assist you with

The crises of recent years have transformed consumer behavior. To stay relevant, retailers must adapt fast and meet rising expectations with engaging, future-proof experiences.

Multibrackets – Complete Indoor & Outdoor Mounting Solutions

The growth of large LED displays gives retailers new ways to redefine their marketplace. By uniting online and in-store messaging, they can create closer customer connections and deliver a true Retail Experience 2.0.

Multibrackets supplies all the indoor and outdoor mounting equipment needed for any project. Our team helps you design standout installations that attract attention and drive engagement in today's competitive retail landscape.

Digital signage with modular LED panels enables flexible, high-resolution displays of any shape or size, merging digital and physical experiences like never before.

Project Start, tailored to You

Partnering with leading LED suppliers, Multibrackets provides the mounting solutions that bring every concept to life, from ceiling and wall displays to window installations.

Multibrackets Tailormade: customized, high-impact digital signage for any project, large or small.

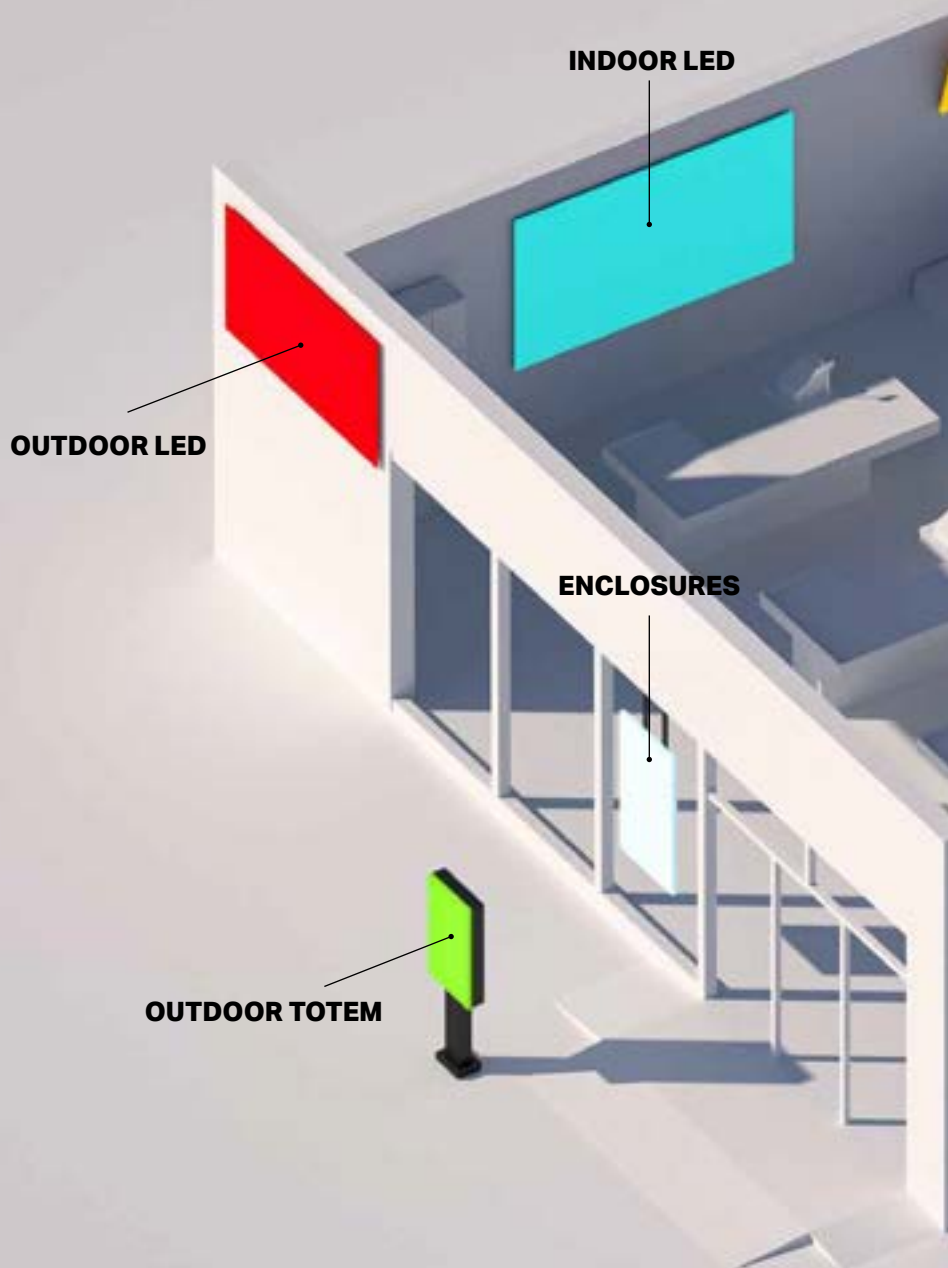

for your Digital Signage projects

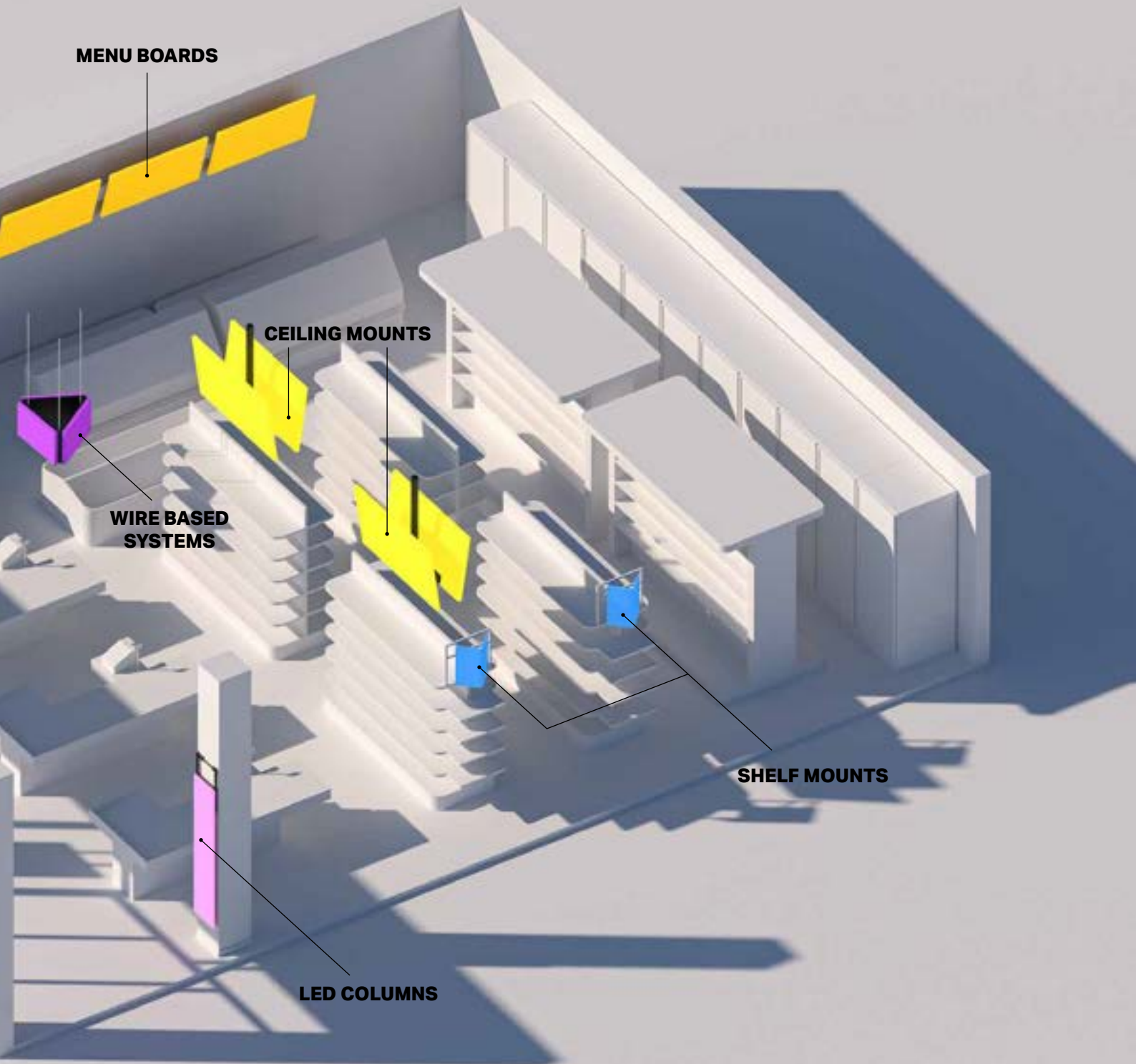

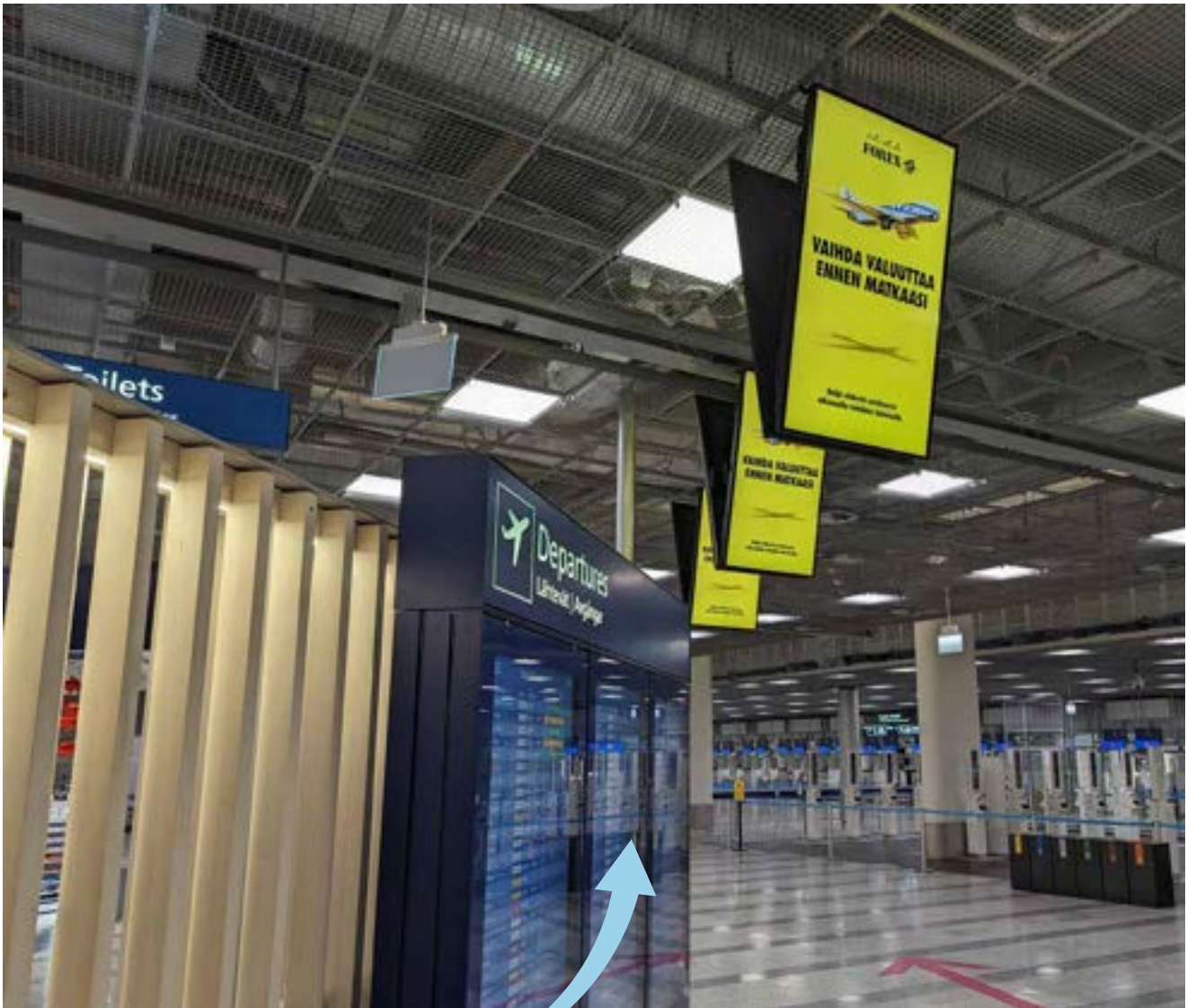

Helsinki airport

Pro Series

Ceiling Mounted Solutions

Ideal for installers and digital signage projects, our ceiling-mounted systems make it possible to create single displays, dual setups, or full video walls in prominent locations where wall space isn't available.

Available in a variety of configurations, these ceiling mounts support commercial displays from 32" to 100".

Designed with space efficiency and ease of installation in mind, they provide a clean, reliable, and professional solution for virtually any commercial environment.



Back to back optional



Cable management



Landscape and portrait



Max load tested 5x



Micro adjustable



Multiple color options

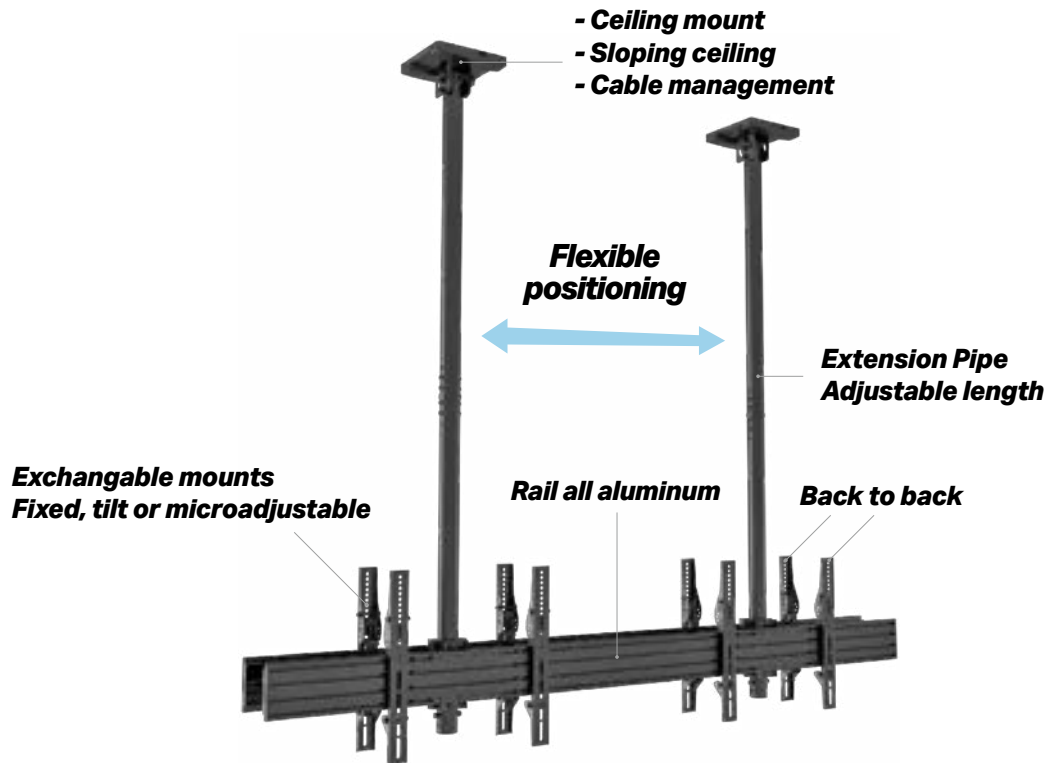

	MBC1U VESA 75/100	MBC2U VESA 75/100	MBC3U VESA 75/100
Model:	MBC1U VESA 75/100	MBC2U VESA 75/100	MBC3U VESA 75/100
EAN:	735010521 8187	735010521 8194	735010521 8200
Screen size:	15"-32"	15"-32"	15"-32"
Type:	Single side MBC1U	Double Side MBC2U	Triple Sided MBC3U
VESA:	From 75x75 to 100x100	75x75, 100x100	From 75x75 to 100x100
Material:	Steel, Aluminium, Plastic	Steel, Aluminium, Plastic	Steel, Aluminium, Plastic
Color:	Black	Black	Black
Surface Finish:	Powder coating / Anodic Oxidation	Powder coating / Anodic Oxidation	Powder coating / Anodic Oxidation
Weight:	10 kg	13 kg	13 kg
Measurements	84.5 x 20 x 11 cm	104.5 x 20 x 14.2 cm	104.5 x 20 x 14.2 cm
Max Load:	10 kg	10 kg per screen	10 kg per screen
Tilt:	Yes, -12°~+12°	Yes, -12°~+12°	Yes, -12°~+12°
Rotate:	360°	360°	360°
Cable Management:	Yes	Yes	Yes
Warranty:	5 years	5 years	5 years

MBC1U VESA 200



MBC1U White VESA 200



MBC1UX2 VESA 200



MBC2X1U VESA 200



	MBC1U VESA 200	MBC1U White VESA 200	MBC1UX2 VESA 200	MBC2X1U VESA 200
Model:	MBC1U VESA 200	MBC1U White VESA 200	MBC1UX2 VESA 200	MBC2X1U VESA 200
Screen size:	24" - 42"	24" - 42"	24" - 42"	30" - 42"
VESA:	VESA 200, 20cm	VESA 200, 20cm	VESA 200, 20cm	VESA 200, 20cm
EAN:	735007373 3897	735002273 8669	735002273 7884	735010521 2253
Max load:	30kg (Per screen)	30kg	30kg (Per screen)	30kg (Per screen)
Bracket type:	Tilt (Fixed optional)	Tilt (Fixed optional)	Tilt (Fixed optional)	Tilt (Fixed optional)
Landscape / portrait:	Yes	Yes	Yes	Yes
Pole length:	80 cm up to 150 cm	80 cm up to 150 cm	80 cm up to 150 cm	80 cm up to 150 cm
Colour (VESA arms):	Black	Black	Black	Black
Colour (Horizontal rail):	Black (Silver optional)	Black (Silver optional)	Black (Silver optional)	Black (Silver optional)
Colour (Poles & ceiling mount):	Black	Black	Black	Black
Warranty:	5 years	5 years	5 years	5 years
Accessories:	Cover plates	Cover plates	Cover plates	Cover plates

MBC2U VESA 200



MBC1UX2 White VESA 200



MBC2UPV 50/100/200



MBC3X1U VESA 200



MBC5X1UP VESA 200



Model:	MBC2U VESA 200	MBC1UX2 White VESA 200	MBC2UPV 50/100/200	MBC3X1U VESA 200	MBC3X1U VESA 200
Screen size:	24" - 42"	24" - 42"	32" - 43"	30" - 42"	30" - 42"
VESA:	VESA 200, 20cm	VESA 200, 20cm	VESA 200, 20cm	VESA 200, 20cm	VESA 200, 20cm
EAN:	734023481 0239	735007373 8267	735010521 2451	735010521 2260	735010521 5568
Max load:	30kg (Per screen)	30kg (Per screen)	30kg (Per screen)	30kg (Per screen)	30kg (Per screen)
Bracket type:	Tilt (Fixed optional)	Fixed	Tilt (Fixed optional)	Tilt (Fixed optional)	Tilt (Fixed optional)
Landscape / portrait:	Portrait	Yes	Yes	Portrait	Yes
Pole length:	80 cm up to 150 cm	80 cm up to 150 cm	80 cm up to 150 cm	80 cm up to 150 cm	80 cm up to 150 cm
Colour (VESA arms):	Black	Black	Black	Black	Black
Colour (Horizontal rail):	Black (Silver optional)	Black (Silver optional)	Black (Silver optional)	Black (Silver optional)	Black (Silver optional)
Colour (Poles & ceiling mount):	Black	White	Black	Black	Black
Warranty:	5 years	5 years	5 years	5 years	5 years
Accessories:	Cover plates	Cover plates	Cover plates	Cover plates	Cover plates

MBC2X1U White VESA 200



MBC5X1UP VESA 200

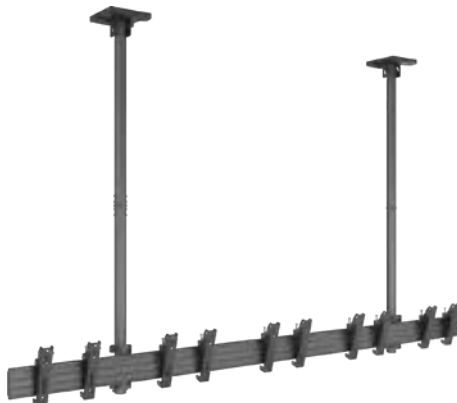

MBC5X1UP-43 VESA 300

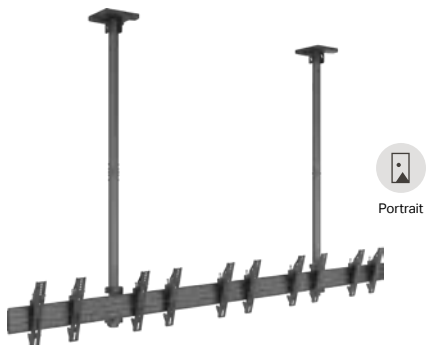

	Model: MBC2X1U White VESA 200	MBC5X1UP VESA 200	MBC5X1UP-43 VESA 300
Screen size:	32"-42"	40" - 65"	43"
VESA:	VESA 200, 20cm	Max 200x200	VESA 300, 30cm
EAN:	735007373 8274	735002273 9185	735010521 9009
Max load:	30kg (Per screen)	30kg (Per screen)	30kg (Per screen)
Bracket type:	Tilt (Fixed optional)	Tilt (Fixed optional)	Tilt (Fixed optional)
Landscape / portrait:	Portrait	Yes	Yes
Pole length:	80 cm up to 150 cm	80 cm up to 150 cm	80 cm up to 150 cm
Colour (VESA arms):	Black	Black	Black
Colour (Horizontal rail):	Black (Silver optional)	Black (Silver optional)	Black (Silver optional)
Colour (Pillar):	Black	Black	Black
Warranty:	5 years	5 years	5 years

MBC1U VESA 300



MBC2X1U VESA 300



MBC1UX2 VESA 75/100



MBC1U B2B VESA 75/100



	MBC1U VESA 300	MBC2X1U VESA 300	MBC1UX2 VESA 75/100	MBC1U B2B VESA 75/100
Model:	MBC1U VESA 300	MBC2X1U VESA 300	MBC1UX2 VESA 75/100	MBC1U B2B VESA 75/100
Screen size:	32" - 50"	32" - 50"	15" - 32"	15" - 32"
VESA:	VESA 300, 30cm	VESA 300, 30cm	75x75, 100x100mm	75x75, 100x100mm
EAN:	735002273 7891	735002273 7907	735002273 9147	735002273 9154
Max load:	30kg (Per screen)	30kg (Per screen)	10kg (Per screen)	10kg (Per screen)
Bracket type:	Fixed (Tilt optional)	Tilt (Fixed optional)	Tilt (Fixed optional)	Tilt (Fixed optional)
Landscape / portrait:	Yes	Yes	Yes	Yes
Pole length:	80 cm up to 150 cm	80 cm up to 150 cm	80 cm up to 150 cm	80 cm up to 150 cm
Colour (VESA arms):	Black	Black	Black	Black
Colour (Horizontal rail):	Black (Silver optional)	Black (Silver optional)	Black (Silver optional)	Black (Silver optional)
Colour (Poles & ceiling mount):	Black	Black	Black	Black
Warranty:	5 years	5 years	5 years	5 years
Accessories:	Cover plates	Cover plates	Cover plates	Cover plates

MBC4X1U VESA 300



MBC4X1U VESA Fixed 300 MBC5X1UP VESA 300 MBC5X1U VESA 300

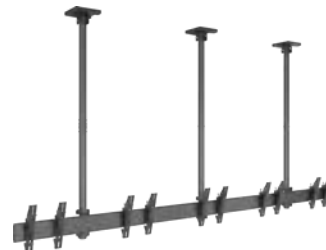
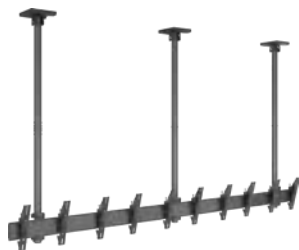

	MBC4X1U VESA 300	MBC4X1U VESA Fixed 300	MBC5X1UP VESA 300	MBC5X1U VESA 300
Model:	MBC4X1U VESA 300	MBC4X1U VESA Fixed 300	MBC5X1UP VESA 300	MBC5X1U VESA 300
Screen size:	32" - 50"	32" - 50"	32" - 50"	32"-50"
VESA:	VESA 300, 30cm	VESA 300, 30cm	VESA 300, 30cm	VESA 300, 30cm
EAN:	735010521 6053	735010521 6220	735002273 7938	734023481 0642
Max load:	30kg (Per screen)	30kg (Per screen)	30kg (Per screen)	30kg (Per screen)
Bracket type:	Tilt (Fixed optional)	Tilt (Fixed optional)	Tilt (Fixed optional)	Tilt (Fixed optional)
Landscape / portrait:	Yes	Yes	Portrait	Portrait
Pole length:	80 cm up to 150 cm	80 cm up to 150 cm	80 cm up to 150 cm	80 cm up to 150 cm
Colour (VESA arms):	Black	Black	Black	Black
Colour (Horizontal rail):	Black (Silver optional)	Black (Silver optional)	Black (Silver optional)	Black (Silver optional)
Colour (Poles & ceiling mount):	Black	Black	Black	Black
Warranty:	5 years	5 years	5 years	5 years
Accessories:	Cover plates	Cover plates	Cover plates	Cover plates

MBC1F VESA 200



MBC1F VESA 400



MBC1F 3m

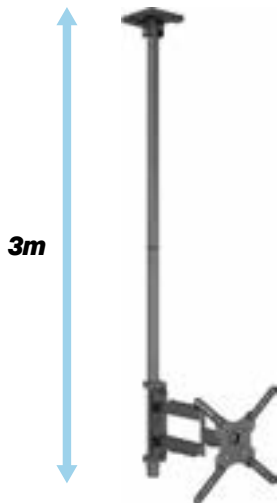

MBC2F 3m



	MBC1F VESA 200	MBC1F VESA 400	MBC1F 3m	MBC2F 3m
Model:	MBC1F VESA 200	MBC1F VESA 400	MBC1F 3m	MBC2F 3m
Screen size:	17" - 42"	17" - 42"	32"-55"	32"-55"
VESA:	VESA 200, 20cm	VESA 400, 40cm	Max 400x400mm	Max 400x400mm
EAN:	735007373 6416	735007373 6423	735010521 8422	735010521 8439
Max load:	30kg (Per screen)	30kg (Per screen)	30kg (Per screen)	30kg (Per screen)
Bracket type:	Tilt	Tilt	Tilt	Tilt
Landscape / portrait:	Yes	Yes	Yes	Yes
Pole length:	80 cm up to 150 cm	80 cm up to 150 cm	300 cm	300 cm
Colour (VESA arms):	Black	Black	Black	Black
Colour (Horizontal rail):	Black (Silver optional)	Black (Silver optional)	Black	Black
Colour (Poles & ceiling mount):	Black	Black	Black	Black
Warranty:	5 years	5 years	5 years	5 years
Accessories:	Cover plates	Cover plates	Cover plates	Cover plates

MBC1U VESA 400 MBC1U White VESA 400 MBC1U2 White VESA 400



MBC1U White

MBC1USD 600 White



	MBC1U VESA 400	MBC1U White VESA 400	MBC1UX2 White VESA 400	MBC1U White	MBC1USD 600 White
Model:	MBC1U VESA 400	MBC1U White VESA 400	MBC1UX2 White VESA 400	MBC1U White	MBC1USD 600 White
Screen size:	17" - 42"	40" - 65"	40" - 65"	40" - 75"	40" - 100"
VESA:	VESA 400, 40cm	VESA 400x400mm	VESA 400x400mm	VESA 600x400mm	VESA 600x400mm
EAN:	735007373 8885	735002273 8638	735002273 8652	735002273 8645	735010521 7289
Max load:	30kg (Per screen)	30kg	30kg (Per screen)	12kg	12kg
Bracket type:	Tilt (Fixed optional)	Tilt (Fixed optional)	Tilt (Fixed optional)	Fixed (Tilt optional)	Tilt (Fixed optional)
Landscape / portrait:	Yes	Portrait	Yes	Yes	Yes
Pole length:	80 cm up to 150 cm	80 cm up to 150 cm	80 cm up to 150 cm	80 cm up to 150 cm	80 cm up to 150 cm
Colour (VESA arms):	Black	Black	Black	Black	Black
Colour (Horizontal rail):	Black (Silver optional)	Black (Silver optional)	Black (Silver optional)	Black (Silver optional)	Black (Silver optional)
Colour (Poles & ceiling mount):	Black	White	White	White	White
Warranty:	5 years	5 years	5 years	5 years	5 years
Accessories:	Cover plates	Cover plates	Cover plates	Cover plates	Cover plates

MBC3X1U

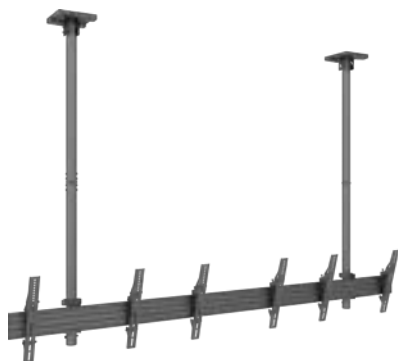

MBC3X1U2

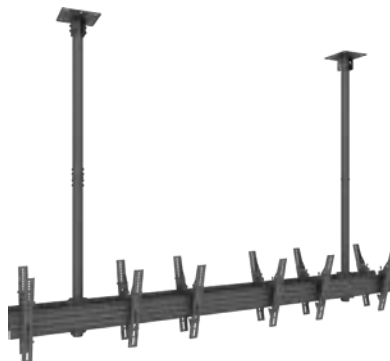

MBC4X1U

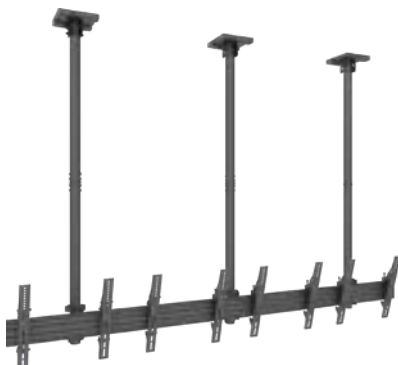

MBC4X1U2

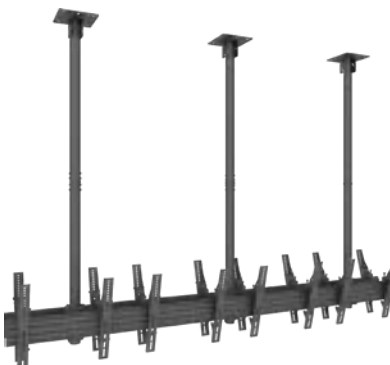

	MBC3X1U	MBC3X1U2	MBC4X1U	MBC4X1U2
Model:	MBC3X1U	MBC3X1U2	MBC4X1U	MBC4X1U2
Screen size:	40" - 65"	40" - 65"	40" - 65"	40" - 65"
VESA:	VESA 400, 40cm	VESA 400, 40cm	VESA 400, 40cm	VESA 400, 40cm
EAN:	735007373 3477	735007373 3507	735007373 3484	735007373 3514
Max load:	30kg (Per screen)	30kg (Per screen)	30kg (Per screen)	30kg (Per screen)
Bracket type:	Tilt (Fixed optional)	Tilt (Fixed optional)	Tilt (Fixed optional)	Tilt (Fixed optional)
Landscape / portrait:	Yes	Yes	Yes	Yes
Pole length:	80 cm up to 150 cm	80 cm up to 150 cm	80 cm up to 150 cm	80 cm up to 150 cm
Colour (VESA arms):	Black	Black	Black	Black
Colour (Horizontal rail):	Black (Silver optional)	Black (Silver optional)	Black (Silver optional)	Black (Silver optional)
Colour (Poles & ceiling mount):	Black	Black	Black	Black
Warranty:	5 years	5 years	5 years	5 years
Accessories:	Cover plates	--	Cover plates	--

MBC2U



MBC2U2

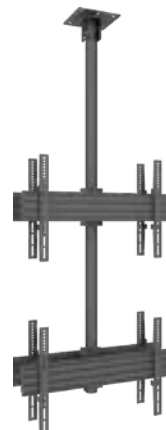

MBC2X2U

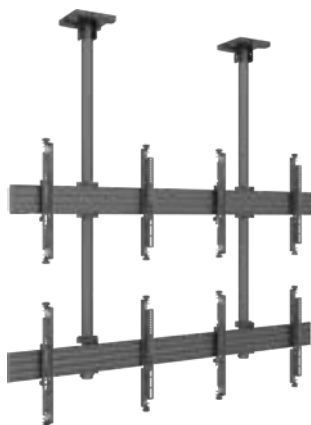

MBC2X2U2

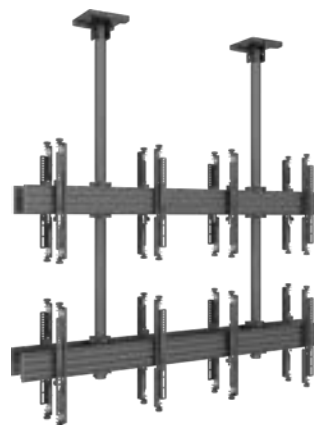

	MBC2U	MBC2U2	MBC2X2U	MBC2X2U2
Model:	MBC2U	MBC2U2	MBC2X2U	MBC2X2U2
Screen size:	40" - 65"	40" - 65"	40" - 65"	46" - 65"
VESA:	VESA 400, 40cm	VESA 400, 40cm	VESA 400, 40cm	VESA 400, 40cm
EAN:	735007373 3545	735007373 3583	735007373 3552	735007373 3590
Max load:	30kg (Per screen)	30kg (Per screen)	30kg (Per screen)	30kg (Per screen)
Bracket type:	Fixed	Fixed	Micro-Adjustable Arms	Micro-Adjustable Arms
Landscape / portrait:	Yes	Yes	Yes	Yes
Pole length:	80 cm up to 150 cm	80 cm up to 150 cm	80 cm up to 150 cm	80 cm up to 150 cm
Colour (VESA arms):	Black	Black	Black	Black
Colour (Horizontal rail):	Black (Silver optional)	Black (Silver optional)	Black (Silver optional)	Black (Silver optional)
Colour (Poles & ceiling mount):	Black	Black	Black	Black
Warranty:	5 years	5 years	5 years	5 years
Accessories:	Cover plates	--	Cover plates	Cover plates

MBC3X2U



MBC3X2U2

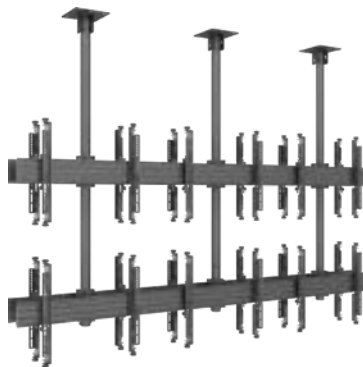







MBC3X3U

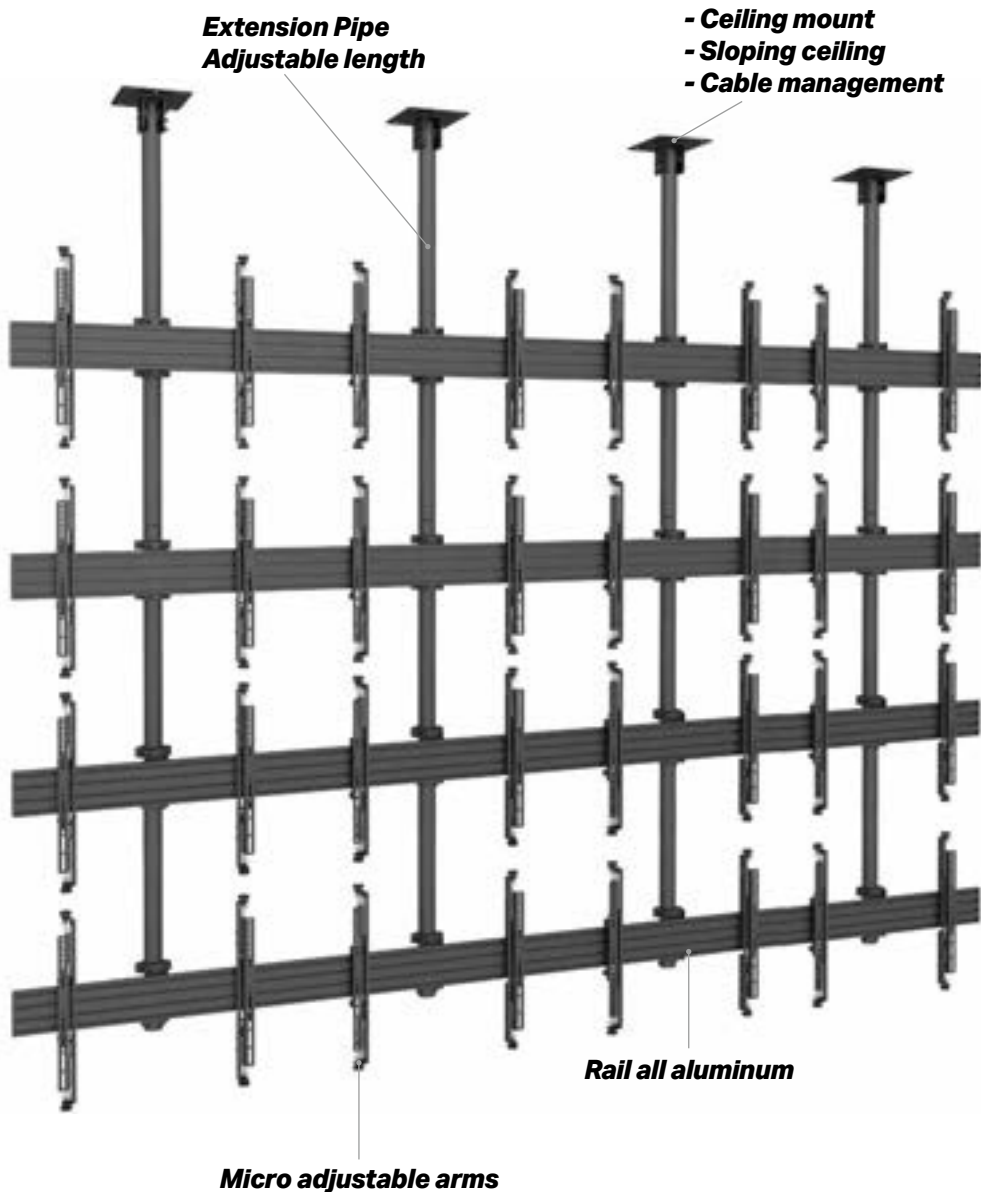

	MBC3X2U	MBC3X2U2	MBC3X3U
Model:	MBC3X2U	MBC3X2U2	MBC3X3U
Screen size:	40" - 65"	40" - 65"	40" - 65"
VESA:	VESA 400, 40cm	VESA 400, 40cm	VESA 400, 40cm
EAN:	735007373 3569	735007373 3606	735007373 3576
Max load:	30kg (Per screen)	30kg (Per screen)	30kg (Per screen)
Bracket type:	Tilt	Tilt	Tilt (Fixed optional)
Landscape / portrait:	Yes	Yes	Yes
Pole length:	80 cm up to 150 cm	80 cm up to 150 cm	80 cm up to 300 cm
Colour (VESA arms):	Black	Black	Black
Colour (Horizontal rail):	Black (Silver optional)	Black (Silver optional)	Black (Silver optional)
Colour (Poles & ceiling mount):	Black	Black	Black
Warranty:	5 years	5 years	5 years
Accessories:	Cover plates	--	--

MBC4X4



-  **Cable management**
-  **Landscape and portrait**
-  **Max load tested 5x**
-  **Micro adjustable**
-  **Back to back (optional)**

Model:	MBC4X4
Screen size:	46" - 65"
VESA:	VESA 400, 40cm
EAN:	735007373 7864
Max load:	30kg (Per screen)
Bracket type:	Micro-Adjustable Arms
Landscape / portrait:	Yes
Pole length:	80 cm up to 300 cm
Colour (VESA arms):	Black
Colour (Horizontal rail):	Black (Silver optional)
Colour (Poles & ceiling mount):	Black
Warranty:	5 years
Accessories:	Cover plates

MBC1USD 1000



MBC1USD 1200



MBC2UPHD



MBC3UPHD



MBC4UPHD

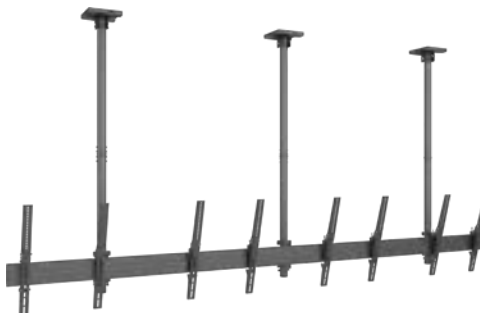

	MBC1USD 1000	MBC1USD 1200	MBC2UPHD	MBC3UPHD	MBC4UPHD
Model:	MBC1USD 1000	MBC1USD 1200	MBC2UPHD	MBC3UPHD	MBC4UPHD
Screen size:	75"-98"	85"-110"	65" - 75"	65" - 75"	65"-75"
VESA:	Max 1000x600mm	Max 1200x600mm	VESA 600, 60cm	Max 400x600mm	Max 400x600mm
EAN:	735010521 8873	735010521 8866	735002273 8102	735002273 8119	735002273 8928
Max load:	135kg	135kg	60kg (Per screen)	10kg (Per screen)	50kg (Per screen)
Bracket type:	Tilt (Fixed optional)	Tilt (Fixed optional)	Tilt (Fixed optional)	Tilt (Fixed optional)	Tilt (Fixed optional)
Landscape / portrait:	Yes	Yes	Yes	Yes	Yes
Pole length:	80 cm up to 150 cm	80 cm up to 150 cm	80 cm up to 150 cm	80 cm up to 150 cm	80 cm up to 150 cm
Colour (VESA arms):	Black	Black	Black	Black	Black
Colour (Horizontal rail):	Black (Silver optional)	Black (Silver optional)	Black (Silver optional)	Black (Silver optional)	Black (Silver optional)
Colour (Poles & ceiling mount):	Black	Black	Black	Black	Black
Warranty:	5 years	5 years	5 years	5 years	5 years
Accessories:	Cover plates	Cover plates	Cover plates	Cover plates	Cover plates



Ceiling Mounted Triple & Quad Solutions



Volvo showroom

Maximize visibility from every angle with our ceiling-mounted triple and quad display solutions. Designed for high-traffic environments such as airports, shopping centers, and showrooms, these systems allow multiple displays to be mounted back-to-back or around a central pole, ensuring content is visible in all directions.

With modular design, integrated cable management, and precise tilt adjustments, these solutions combine professional functionality with a clean, minimal aesthetic. Perfect for creating powerful digital signage that reaches your audience from every side.

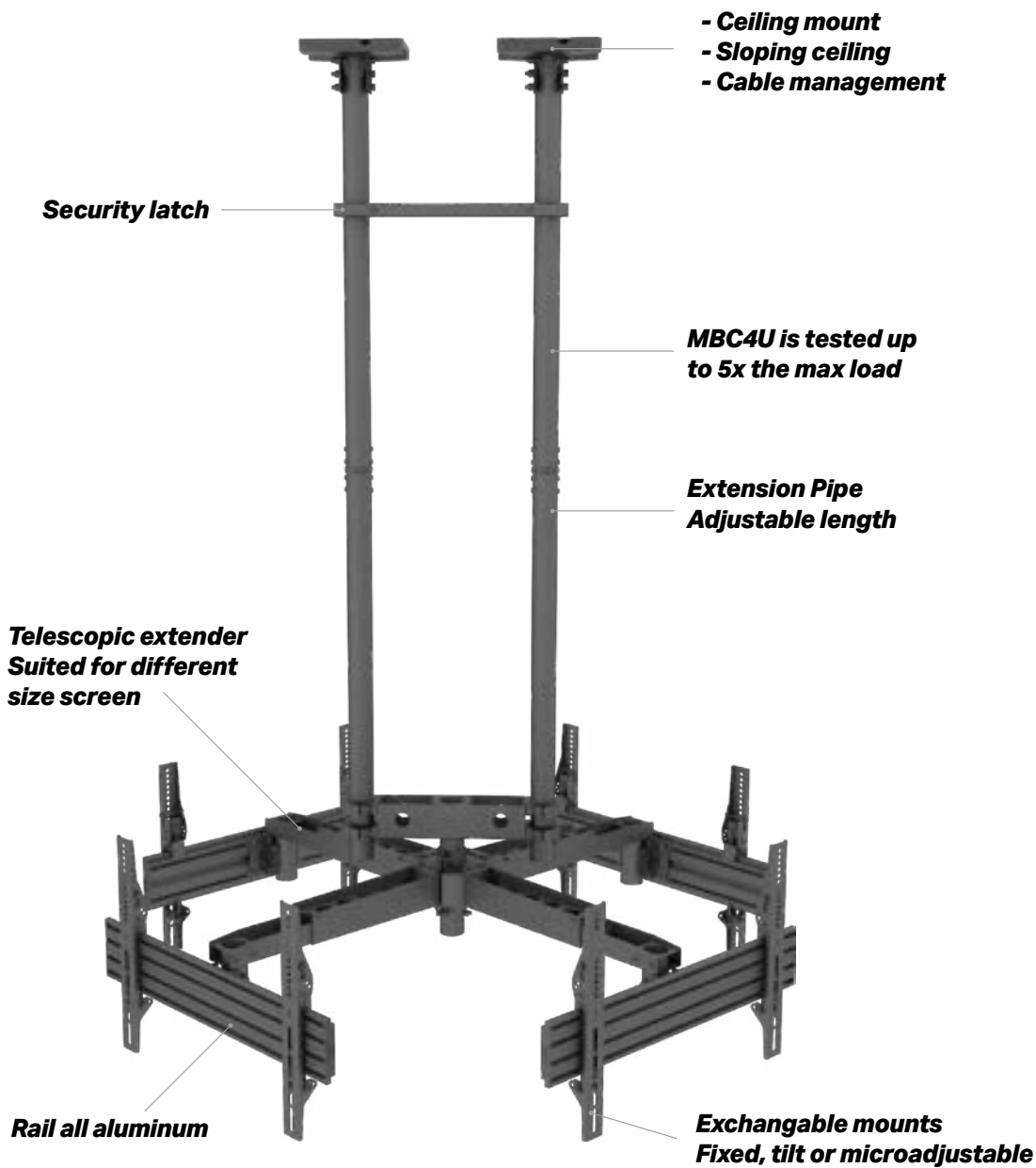

Perfect in locations where 360° visibility is important.



Pro Series tested for 5 times the max load



Selected models are TUV approved



Design plate cover ceiling installation



MBC3U



MBC4U



MBC3UHD



MBC2P4U



	MBC3U	MBC4U	MBC3UHD	MBC2P4U
Model:	MBC3U	MBC4U	MBC3UHD	MBC2P4U
Screen size:	32" - 65"	32" - 65"	50" - 75"	50" - 75"
VESA:	VESA 400, 40cm	VESA 400, 40cm	VESA 400, 40cm	VESA 400, 40cm
EAN:	735007373 3521	735007373 3538	735007373 8861	735007373 8878
Max load:	30kg (Per screen)	30kg (Per screen)	30kg (Per screen)	30kg (Per screen)
Bracket type:	Tilt	Tilt	Tilt	Tilt
Landscape / portrait:	Yes	Yes	Yes	Yes
Pole length:	80 cm up to 300 cm	80 cm up to 300 cm	80 cm up to 300 cm	80 cm up to 300 cm
Colour (VESA arms):	Black	Black	Black	Black
Colour (Horizontal rail):	Black (Silver optional)	Black (Silver optional)	Black (Silver optional)	Black (Silver optional)
Colour (Poles & ceiling mount):	Black	Black	Black	Black
Warranty:	5 years	5 years	5 years	5 years
Accessories:	Cover plates	Cover plates	Cover plates	Cover plates

MBC8U

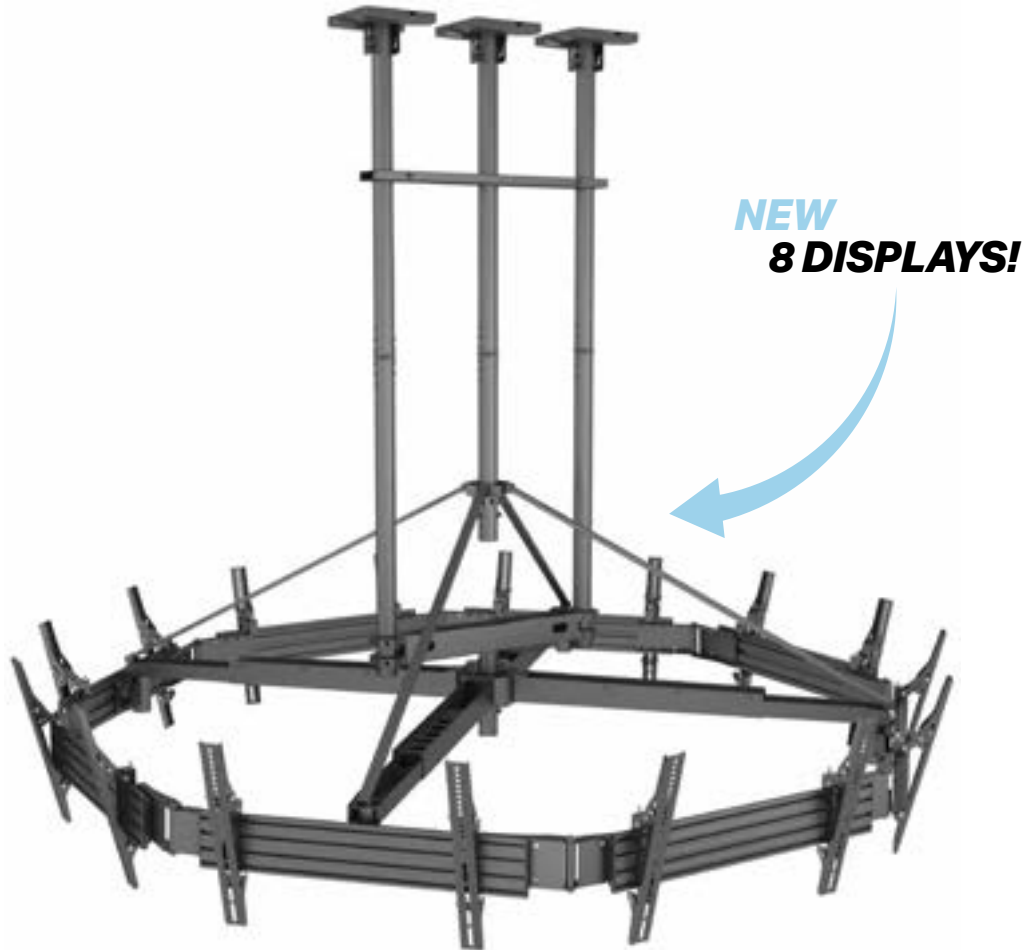

**NEW
8 DISPLAYS!**

Go full circle! The Octagon

Ceiling Mounted 8-Screen Circle Solution. Our ceiling-mounted circle solution is designed to hold up to eight displays in a 360° configuration. Ideal for airports, retail spaces, arenas, and other high-traffic environments, it ensures

maximum visibility from every angle. Built with robust materials and professional engineering, it provides a stable, safe, and sleek installation that transforms any space into a powerful digital signage hub.

Model:	MBC8U
Screen size:	32" - 65"
VESA:	VESA 600x400mm
EAN:	735010521 6251
Max load:	30kg (Per screen)
Bracket type:	Tilt (Fixed optional)
Landscape / portrait:	Yes
Pole length:	80 cm up to 300 cm
Colour (VESA arms):	Black
Colour (Horizontal rail):	Black (Silver optional)
Colour (Poles & ceiling mount):	Black
Warranty:	5 years
Accessories:	Cover plates

Large Screen Ceiling Mounts





The Dual Pole range of Pro Series ceiling mounts is designed to support one or two large displays, mounted back-to-back in either landscape or portrait orientation.

Combining easy installation with a clean, modern design, the Dual Pole system is both robust and highly functional, ideal for a wide variety of environments such as retail stores, classrooms, training rooms, lobbies, auditoriums, or exhibition halls.

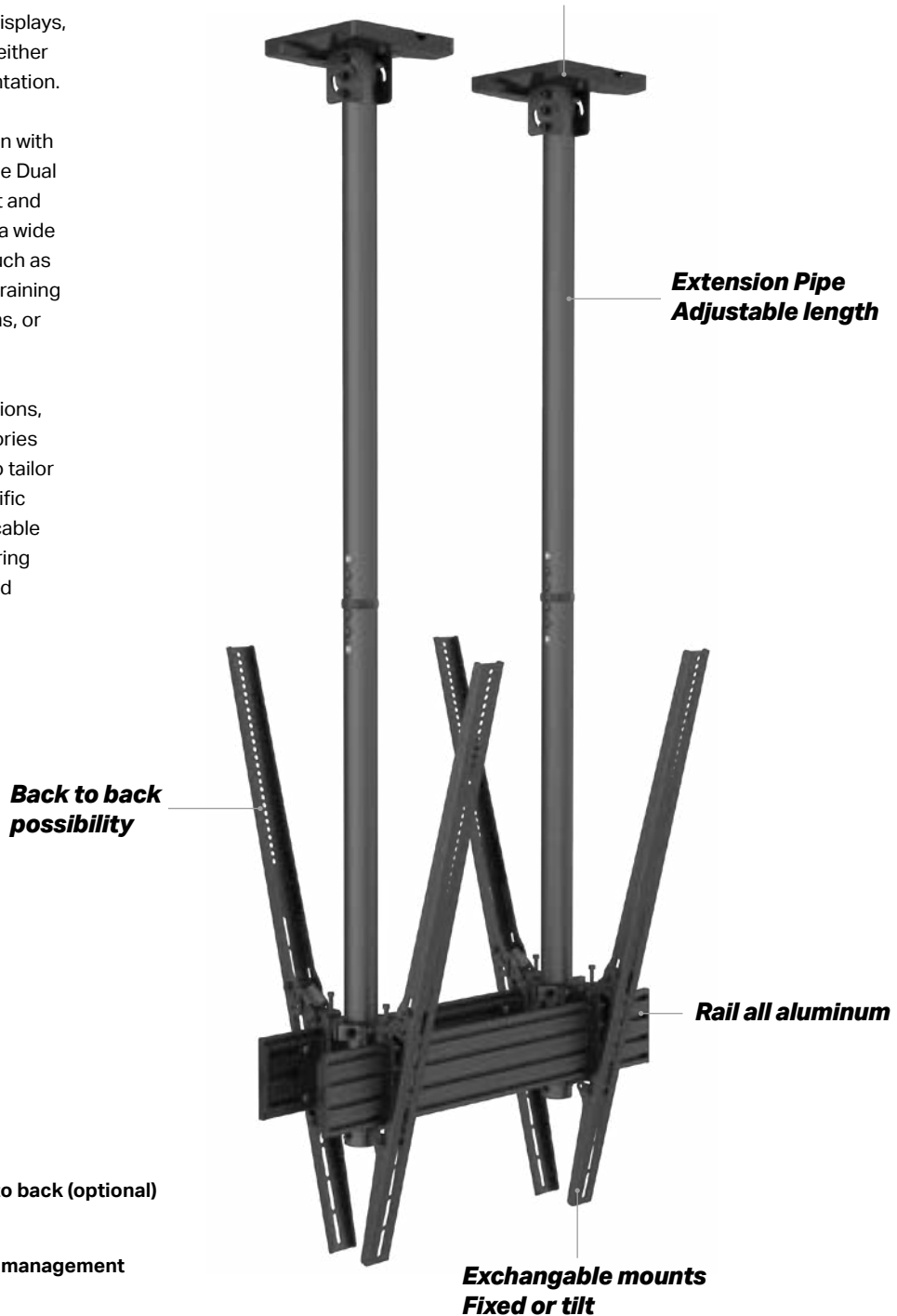
As with all Pro Series solutions, a complete line of accessories is available, allowing you to tailor functionality to meet specific requirements. Integrated cable management keeps AV wiring hidden, ensuring a neat and professional appearance.

- Ceiling mount
- Sloping ceiling
- Cable management



-  **Back to back (optional)**
-  **Cable management**
-  **Landscape and portrait**
-  **Max load tested**

MBC1USD 600



BC1USD 600 White



MBC1UX2SD 600



MBC4X1U VESA 200



MBC1USD 900 White



Model:	MBC1USD 600	MBC1UPHD2	MBC1USD 600 White	MBC1UX2SD 600	MBC1USD 900 White
Screen size:	40" - 100"	40" - 100"	40"-100"	40" - 75"	40" - 100"
VESA:	VESA 600x400mm	VESA 400x600mm	VESA 400x600mm	VESA 600x400mm	VESA 900x600mm
EAN:	735010521 2321	735010521 6404	7350105217 289	735010521 4677	735010521 7371
Max load:	120kg	75kg (Per screen)	120 kg per screen	30kg (Per screen)	120kg
Bracket type:	Tilt (Fixed optional)	Tilt (Fixed optional)	Tilt (Fixed optional)	Tilt (Fixed optional)	Tilt (Fixed optional)
Landscape / portrait:	Yes	Yes	Yes	Yes	Yes
Pole length:	80 cm up to 150 cm	80 cm up to 150 cm	80 cm up to 150 cm	80 cm up to 150 cm	80 cm up to 150 cm
Colour (VESA arms):	Black	Black	Black	Black	Black
Colour (Horizontal rail):	Black (Silver optional)	Black (Silver optional)	Black (Silver optional)	Black (Silver optional)	Black (Silver optional)
Colour (Poles & ceiling mount):	Black	Black	White	Black	White
Warranty:	5 years	5 years	5 years	5 years	5 years
Accessories:	Cover plates	Cover plates	Cover plates	Cover plates	Cover plates

What is Gravity Center?

A robust and innovative ceiling pole designed to securely hang displays by aligning with their natural center of gravity.

This unique design ensures straighter and more stable installations, especially for larger or heavier displays.

By angling the column to match the display's center of gravity with the mounting point, it reduces stress on the coupler joint, preventing unwanted movement or disruption of the column.

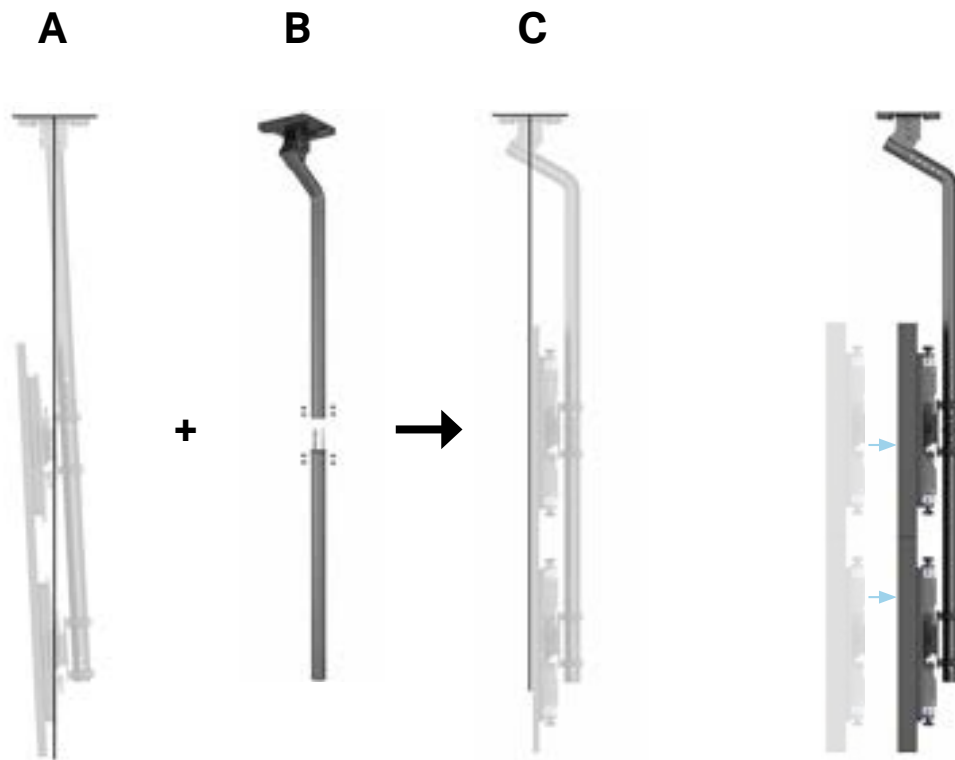

Extension Pipe 0.915m Gravity Center Black / White



MBC1UGC VESA 600



MBC1USDGC 600



MBC1USDGC 900



	Extension Pipe 0.915m Gravity Center Black / White	MBC1UGC VESA 600	MBC1USDGC 600	MBC1USDGC 900
Model:	Extension Pipe 0.915m Gravity Center Black / White	MBC1UGC VESA 600	MBC1USDGC 600	MBC1USDGC 900
EAN:	7350105213649 / 7350105219443	734023481 1908	734023481 1922	734023481 1915
Screen size:	-	40"-75"	40"-100"	40" - 100 "
Type:	-	Single Side MBC1U	Single Side	Single Side
VESA:	-	Max 600x400	Max 600x400	100x100 to 900x600
Material:	Plastic, Aluminum	Steel, Aluminium, Plastic	Steel, Aluminium, Plastic	Steel, Aluminium, Plastic
Colour:	Black / White	Black	Black	Black
Surface Finish:	Powder coating / Anodic Oxidation	Powder coating / Anodic Oxidation	Powder coating / Anodic Oxidation	Powder coating / Anodic Oxidation
Weight:	2,5 kg	8.5 kg	18 kg	19 kg
Measurements:	96 x 5.5 x 25.5 cm	96x25.5x13cm	96x25.5x22cm	104x25.5x21cm
Max load:	-	45 kg (TÜV approved at 30 kg per screen)	120 kg per screen	135 kg
Tilt:	-	Yes, -6°~+15°	Yes, -6°~+15°	Yes, -6°~+15°
Swivel:	-	Yes, 360°	Yes, 360°	Yes, 90°
Rotate:	-	Yes, ±4°	0°	Yes, ±4°
Cable Management:	Yes	Yes	Yes	Yes
Options:	-	Extension pipes : 0.8m, 1.5m, 3.0m	Extension pipes : 0.8m, 1.5m, 3.0m	Extension pipes : 0.8m, 1.5m, 3.0m
Warranty:	5 years	5 years	5 years	5 years

MBC1UHD



MBC1USD



MBC1UX2HD



MBC1UX2SD



	MBC1UHD	MBC1USD	MBC1UX2HD	MBC1UX2SD
Model:	MBC1UHD	MBC1USD	MBC1UX2HD	MBC1UX2SD
Screen size:	40" - 75"	40" - 100"	40" - 75"	40" - 100"
VESA:	VESA 600, 60cm	VESA 600, 60cm	VESA 600, 60cm	VESA 600, 60cm
EAN:	735007373 5778	735007373 5785	735007373 6232	735007373 6249
Max load:	90kg	135kg (Per screen)	90kg (Per screen)	90kg (Per screen)
Bracket type:	Tilt (Fixed optional)	Tilt (Fixed optional)	Tilt (Fixed optional)	Tilt (Fixed optional)
Landscape / portrait:	Yes	Yes	Yes	Yes
Pole length:	80 cm up to 150 cm	80 cm up to 150 cm	80 cm up to 150 cm	80 cm up to 150 cm
Colour (VESA arms):	Black	Black	Black	Black
Colour (Horizontal rail):	Black (Silver optional)	Black (Silver optional)	Black (Silver optional)	Black (Silver optional)
Colour (Poles & ceiling mount):	Black	Black	Black	Black
Warranty:	5 years	5 years	5 years	5 years
Accessories:	Cover plates	Cover plates	Cover plates	Cover plates

MBC1UPHD



MBC1UPSD



MBC1UX2PHD



MBC1UX2PSD



	MBC1UPHD	MBC1UPSD	MBC1UX2PHD	MBC1UX2PSD
Model:	MBC1UPHD	MBC1UPSD	MBC1UX2PHD	MBC1UX2PSD
Screen size:	40" - 75"	40" - 100"	40" - 75"	40" - 100"
VESA:	VESA 900, 90cm	VESA 900, 90cm	VESA 900, 90cm	VESA 900, 90cm
EAN:	735007373 6126	735007373 6133	735007373 6256	735007373 6263
Max load:	90kg	180kg	90kg (Per screen)	90kg (Per screen)
Bracket type:	Tilt (Fixed optional)	Tilt (Fixed optional)	Tilt (Fixed optional)	Tilt (Fixed optional)
Landscape / portrait:	Yes	Yes	Yes	Yes
Pole length:	80 cm up to 150 cm	80 cm up to 150 cm	80 cm up to 150 cm	80 cm up to 150 cm
Colour (VESA arms):	Black	Black	Black	Black
Colour (Horizontal rail):	Black (Silver optional)	Black (Silver optional)	Black (Silver optional)	Black (Silver optional)
Colour (Poles & ceiling mount):	Black	Black	Black	Black
Warranty:	5 years	5 years	5 years	5 years
Accessories:	Cover plates	Cover plates	Cover plates	Cover plates

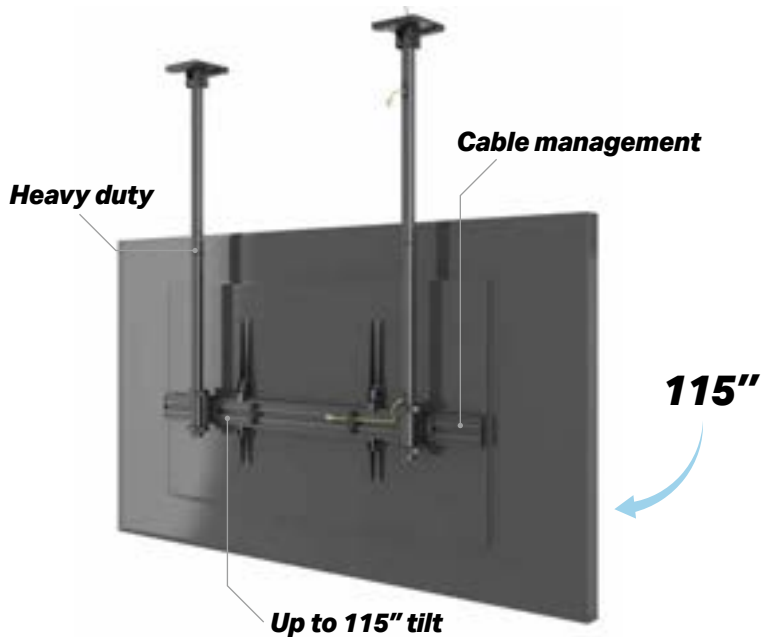

Screen size:
75", 86", 98", 110", 115"

Model:	M Ceiling Mount Pro MBC1USD 1600
Screen size:	75" - 115"
VESA:	VESA 1500x600mm
EAN:	735010521 4561
Max load:	80kg
Bracket type:	Tilt (Fixed optional)
Landscape / portrait:	Yes
Pole length:	80 cm up to 150 cm
Colour (VESA arms):	Black
Colour (Horizontal rail):	Black (Silver optional)
Colour (Poles & ceiling mount):	Black
Warranty:	5 years
Accessories:	Cover plates

MBC2UPSD



MBC3UPSD



MBC2X2U HD

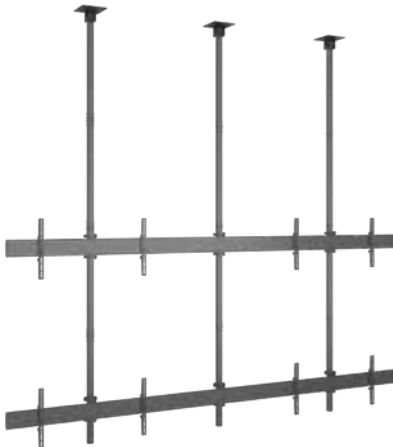

MBC2X2UGC HD

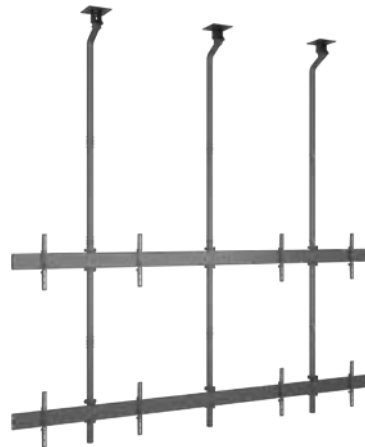

	MBC2UPSD	MBC3UPSD	MBC2X2U HD	MBC2X2UGC HD
Model:	MBC2UPSD	MBC3UPSD	MBC2X2U HD	MBC2X2UGC HD
Screen size:	75" - 86"	65" - 75"	75" - 100"	75" - 100"
VESA:	400x400, 400x600, 400x900mm	400x400, 400x600, 400x900mm	Max 600x400mm	Max 800x400mm
EAN:	735010521 7852	735002273 8911	735002273 3923	735002273 3930
Max load:	60 kg (Per screen)	30 kg (Per screen)	50kg (Per screen)	50kg (Per screen)
Bracket type:	Tilt	Tilt	Fixed	Fixed
Landscape / portrait:	Yes	Yes	Yes	Yes
Pole length:	580 mm - 1550 mm	580 mm - 1550 mm	80 cm up to 150 cm	80 cm up to 330 cm
Colour (VESA arms):	Black	Black	Black	Black
Colour (Horizontal rail):	Black	Black	Black (Silver optional)	Black (Silver optional)
Colour (Poles & ceiling mount):	Black	Black	Black	Black
Warranty:	5 years	5 years	5 years	5 years
Accessories:	Cover plates	Cover plates	Cover plates	Cover plates

CCTV / Camera Ceiling Mounts

Affordable and flexible ceiling installations

The Pro Series CCTV camera mounts are designed for retail and commercial environments where fixed dome or fixed box cameras need to be positioned under high ceilings. Featuring telescopic functionality, the extension length can be easily adjusted from 1 m to 6 m for secure and precise placement.

Compatible with the Pro Series rail system and accessories, these lightweight yet robust mounts offer maximum flexibility. Each ceiling mount can also be rotated 90° for horizontal wall mounting, making them a perfect choice for sloping ceilings or on-wall installations.

Highlights:

- Works with most CCTV and dome cameras solutions
- Suitable for indoor use
- Perfect for retail and commercial environment
- Extendable between 1.5 to 6 meters
- Lightweight and robust
- Available in black or white colors

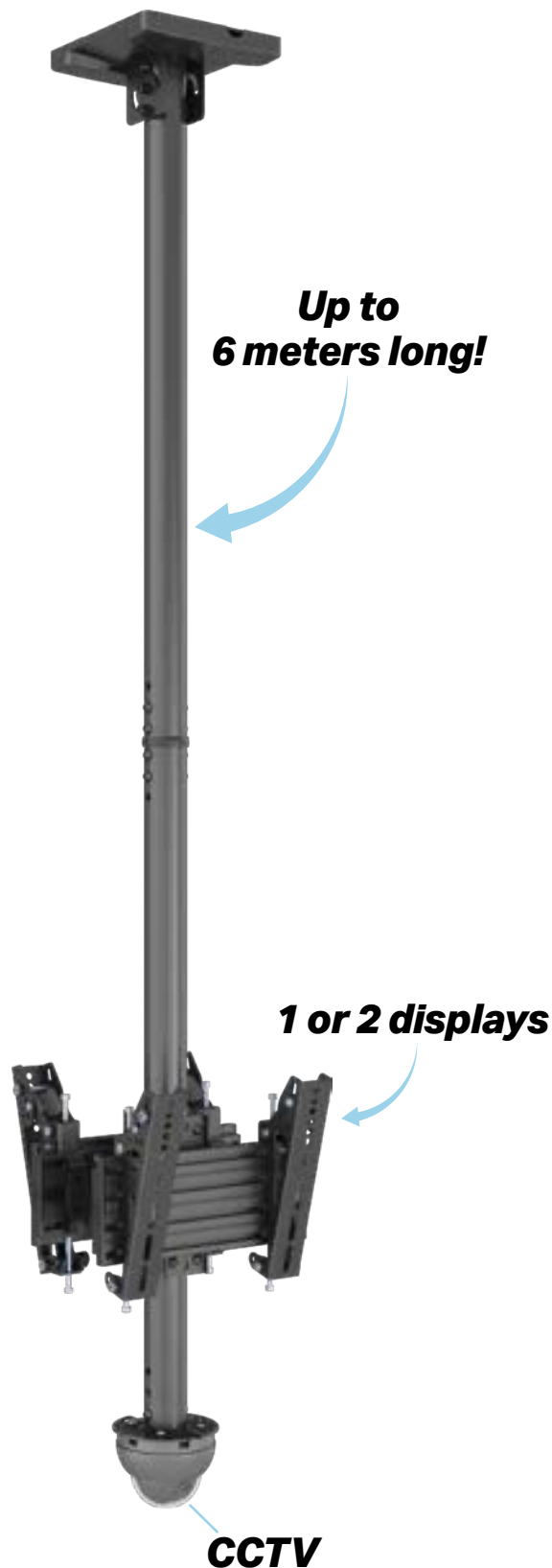

Model:	M Ceiling Mount Pro CTV MBC1UX2 VESA 200
EAN:	735010521 6596
Material:	Steel, Aluminium
Color:	Black
Surface Finish:	Powder coating / Anodic Oxidation
Weight:	11 kg
Measurements	82 x 20 x 13 cm
Max Load:	30 kg
Tilt:	90°
Swivel:	360°
Rotate:	0°
Cable Management:	Yes
Warranty:	5 years

CCTV Ceilingmount White/Black



CCTV MBC1U VESA 75/100



CCTV MBC1U White VESA 200



CCTV MBC1UX2 VESA 200



CCTV MBC2X1U VESA 200



	Model: CCTV Ceilingmount White	CCTV MBC1U VESA 75/100	CCTV MBC1U White VESA 200	CCTV MBC1U VESA 200	CCTV MBC1U VESA 200
Screen size:	For CCTV cameras	For CCTV cameras	24" - 42"	24" - 42"	24" - 42"
VESA:	Universal camera mount	Universal camera mount	VESA200,20cm	VESA200,20cm	VESA200,20cm
EAN:	735010521 6480/ 6411	734023481 1373	735010521 6589	735010521 6596	735010521 6602
Max load:	30kg	30kg	30kg	30kg (Per screen)	30kg (Per screen)
Bracket type:	--	Tilt	Fixed (Tilt optional)	Tilt (Fixed optional)	Tilt (Fixed optional)
Landscape / portrait:	--	Yes	Yes	Yes	Yes
Pole length:	80 cm up to 150 cm	80 cm up to 150 cm	80 cm up to 150 cm	80 cm up to 150 cm	80 cm up to 150 cm
Colour (VESA arms):	Black	Black	Black	Black	Black
Colour (Horizontal rail):	Black (Silver optional)	Black (Silver optional)	Black (Silver optional)	Black (Silver optional)	Black (Silver optional)
Colour (Poles & ceiling mount):	White / Black	Black	White	Black	Black
Warranty:	5 years	5 years	5 years	5 years	5 years
Accessories:	Cover plates	Cover plates	Cover plates	Cover plates	Cover plates



Pro Series Wallmounts

From Wall / Wall to Wall

When displays need to be mounted perpendicular to a wall, the M Pro Series From Wall and Wall to Wall models provide the perfect solution. Designed for open areas such as hallways, concourses, aisles, and office spaces, these mounts ensure maximum visibility where clear

communication is essential. The brackets mount vertically, allowing displays to be positioned perpendicular to a single wall or between two walls. Available as single or double-sided solutions, they are ideal for wayfinding, directional signage, or high-visibility digital information in

high-traffic environments. With a clean Scandinavian design, durable construction, and simple installation process (including all necessary hardware) the M Pro Series From Wall / Wall to Wall offers both practicality and aesthetics in one solution.

MBFW1U VESA200



MBFW1U

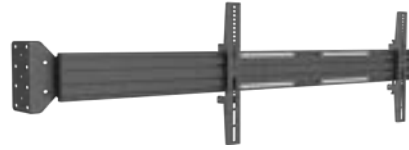

MBFW1UX2



MBWW1U Fixed (125cm)



MBWW2U Fixed (200cm)





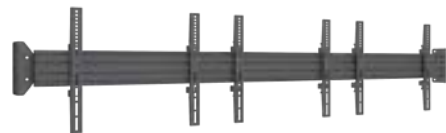

MBWW3U Fixed (300cm)

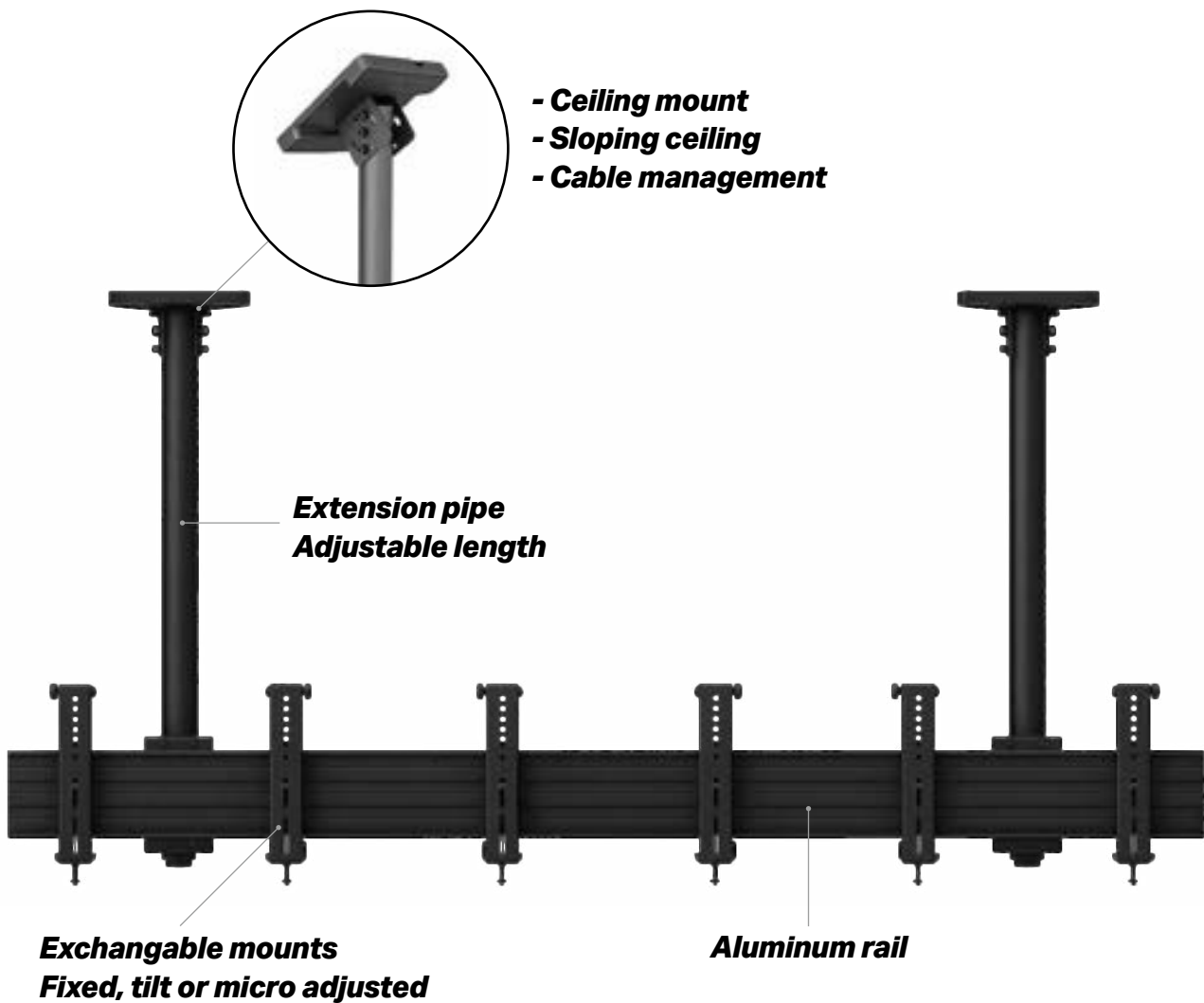

Model:	MBFW1U VESA200	MBFW1U	MBFW1UX2	MBWW1U Fixed (125cm)	MBWW2U Fixed (200cm)	MBWW3U Fixed (300cm)
Screen size:	17" - 42"	42" - 65"	42" - 65"	32" - 75"	32" - 75"	32" - 75"
VESA:	VESA 200, 20cm	VESA 400, 40cm	VESA 400, 40cm	VESA 400, 40cm	VESA 400, 40cm	VESA 400, 40cm
EAN:	735007373 7666	735007373 7642	735007373 7659	735007373 7826	735007373 7833	735007373 7840
Max load:	30 kg (Per screen)	30 kg (Per screen)	30 kg (Per screen)	40 kg	30 kg (Per screen)	30 kg (Per screen)
Bracket type:	Fixed	Fixed	Fixed	Fixed	Fixed	Tilt
Landscape/portrait:	Yes	Yes	Yes	Yes	Yes	Yes
Colour (VESA arms):	Black	Black	Black	Black	Black	Black
Colour (horizontal rail):	Black (Silver optional)	Black (Silver optional)	Black (Silver optional)	Black (Silver optional)	Black (Silver optional)	Black (Silver optional)
Warranty:	5 years	5 years	5 years	5 years	5 years	5 years



- 
 Micro adjustable
- 
 Back to back (optional)
- 
 Cable management
- 
 Landscape and portrait
- 
 Max load tested 5x

Ceiling-Mounted Menu Board Mounts

- Universal design suitable for all sized screens up to 100"
- High-end aesthetics
- Designed to handle landscape or portrait mounting
- Brackets fixed, tilt or micro adjustable
- Support a wide range of VESA 75/100/200/300/400/600/900
- Built in levelling screws to adjust the screen height
- Built in cable management
- Add or change displays after time, Pro Series follows
- Selected models are TUV certified





Flexible menu boards. Starting at 1U builds up to 10U's side by side, landscape or portrait.

Our Menuboard

The Pro Series menu boards are designed for installers and digital signage projects, available in both ceiling-mounted and wall-mounted configurations.

Ceiling-mounted solutions make it possible to build single displays, dual setups, or full video walls in locations where

wall space isn't available. Supporting commercial displays from 32" to 100", they come in a variety of arrangements to suit any installation.

With their space-saving design, menu boards are ideal for public environments such as restaurants, receptions,

and retail spaces. Screens can be mounted in landscape or portrait orientation, with tilt adjustment for improved overhead visibility.

As part of the modular Pro Series, menu boards can be combined with other products in the range to create virtually unlimited configurations.

High-end aesthetics, flexible options for fixed, tilted, or micro-adjustable brackets, and levelling screws for precise alignment make achieving a perfect screen-to-screen fit simple.

MBC1X1U VESA 200



MBC2X1U VESA 200



MBC3X1U VESA 200



MBC4X1U VESA 200



MBC5X1UP VESA 200



MBC6X1U VESA 200



	MBC1X1U VESA 200	MBC2X1U VESA 200	MBC3X1U VESA 200	MBC4X1U VESA 200	MBC5X1UP VESA 200	MBC6X1U VESA 200
Model:	MBC1X1U VESA 200	MBC2X1U VESA 200	MBC3X1U VESA 200	MBC4X1U VESA 200	MBC5X1UP VESA 200	MBC6X1U VESA 200
Screen size:	24" - 43"	30" - 42"	27" - 32"	27" - 32"	27" - 32"	27" - 32"
VESA:	VESA 200, 20cm	VESA 200, 20cm	VESA 200, 20cm	VESA 200, 20cm	VESA 200, 20cm	VESA 200, 20cm
EAN:	735010521 2321	735010521 2253	735007373 5662	735007373 5679	735010521 5063	735010521 6398
Max load:	30kg	30kg	30kg (Per screen)	30kg (Per screen)	30kg (Per screen)	30kg (Per screen)
Bracket type:	Tilt (Fixed optional)	Tilt (Fixed optional)	Tilt (Fixed optional)	Tilt (Fixed optional)	Tilt (Fixed optional)	Tilt (Fixed optional)
Landscape / portrait:	Yes	Landscape	Landscape	Landscape	Portrait	Landscape
Pole length:	80 cm	80 cm	80 cm	80 cm	80 cm	80 cm
Colour (VESA arms):	Black	Black	Black	Black	Black	Black
Colour (Horizontal rail):	Black (Silver optional)	Black (Silver optional)	Black (Silver optional)	Black (Silver optional)	Black (Silver optional)	Black (Silver optional)
Colour (Poles & ceiling mount):	Black	Black	Black	Black	Black	Black
Warranty:	5 years	5 years	5 years	5 years	5 years	5 years
Accessories:	Cover plates	Cover plates	Cover plates	Cover plates	Cover plates	Cover plates

MBC1U, VESA 300



MBC2X1U, VESA 300



MBC3X1U, VESA 300



MBC4X1UP

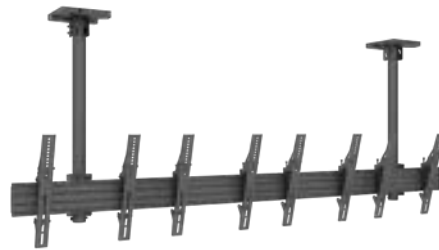

	MBC1U, VESA 300	MBC2X1U, VESA 300	MBC3X1U, VESA 300	MBC4X1UP
Model:	MBC1U, VESA 300	MBC2X1U, VESA 300	MBC3X1U, VESA 300	MBC4X1UP
Screen size:	32" - 50"	32" - 50"	32" - 50"	32" - 65"
VESA:	VESA 300, 30cm	VESA 300, 30cm	VESA 300, 30cm	VESA 400, 40cm
EAN:	735002273 7891	735002273 7907	735002273 7914	735007373 4931
Max load:	30kg (Per screen)	30kg (Per screen)	30kg (Per screen)	30kg (Per screen)
Bracket type:	Tilt (Fixed optional)	Tilt (Fixed optional)	Tilt (Fixed optional)	Tilt (Fixed optional)
Landscape / portrait:	Landscape	Landscape	Landscape	Portrait
Pole length:	80 cm up to 150 cm	80 cm up to 150 cm	80 cm up to 150 cm	80 cm up to 150 cm
Colour (VESA arms):	Black	Black	Black	Black
Colour (Horizontal rail):	Black (Silver optional)	Black (Silver optional)	Black (Silver optional)	Black (Silver optional)
Colour (Poles & ceiling mount):	Black	Black	Black	Black
Warranty:	5 years	5 years	5 years	5 years
Accessories:	Cover plates	Cover plates	Cover plates	Cover plates

MBC4X1U VESA 300



MBC5X1UP VESA 300



MBC4X1U VESA Fixed 300



MBC4X1UGC



	MBC4X1U VESA 300	MBC5X1UP VESA 300	MBC4X1U VESA Fixed 300	MBC4X1UGC
Model:	MBC4X1U VESA 300	MBC5X1UP VESA 300	MBC4X1U VESA Fixed 300	MBC4X1UGC
Screen size:	32" - 50"	32" - 50"	32"-50"	32"-50"
VESA:	VESA 300, 30cm	VESA 300, 30cm	VESA 300, 30cm	VESA 300, 30cm
EAN:	735010521 6473	735002273 7938	735010521 6466	735010521 6473
Max load:	30kg (Per screen)	30kg (Per screen)	30kg (Per screen)	30kg (Per screen)
Bracket type:	Tilt (Fixed optional)	Tilt (Fixed optional)	Fixed (Tilt optional)	Tilt (Fixed optional)
Landscape / portrait:	Landscape	Portrait	Landscape	Landscape
Pole length:	80 cm up to 150 cm	80 cm up to 150 cm	80 cm up to 150 cm	80 cm up to 150 cm
Colour (VESA arms):	Black	Black	Black	Black
Colour (Horizontal rail):	Black (Silver optional)	Black (Silver optional)	Black (Silver optional)	Black (Silver optional)
Colour (Poles & ceiling mount):	Black	Black	Black	Black
Warranty:	5 years	5 years	5 years	5 years
Accessories:	Cover plates	Cover plates	Cover plat	Cover plates

MBC1X1U VESA 400

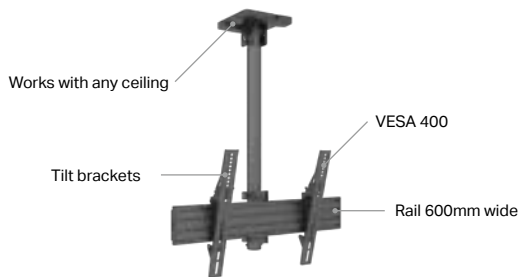

MBC2X1U VESA 400



MBC3X1U VESA 400

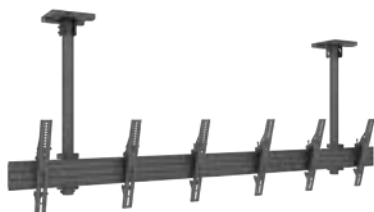



MBC4X1U VESA 400



MBC5X1U VESA 400

Build menuboards five displays wide, or even wider!



-  Landscape or portrait
-  Cable management

MBC5X1UP VESA 400

7350105215070 M Menu Board Mount Pro MBC5X1UP

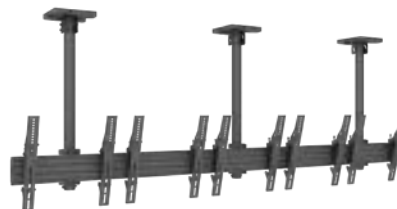

Model:	MBC1X1U	MBC2X1U	MBC3X1U	MBC4X1U	MBC5X1U	MBC5X1UP
Screen size:	32" - 65"	32" - 65"	32" - 65"	32" - 65"	40" - 65"	32" - 55"
VESA:	VESA 400, 40cm	VESA 400, 40cm	VESA 400, 40cm	VESA 400, 40cm	VESA 400, 40cm	VESA 400, 40cm
EAN:	735010521 2338	735007373 3460	735007373 4924	735007373 3484	735010521 5360	735010521 5070
Max load:	30kg (Per screen)	30kg (Per screen)	30kg (Per screen)	30kg (Per screen)	30kg (Per screen)	30kg (Per screen)
Bracket type:	Tilt (Fixed optional)	Tilt (Fixed optional)	Tilt (Fixed optional)	Tilt (Fixed optional)	Tilt (Fixed optional)	Tilt (Fixed optional)
Landscape / portrait:	Yes	Landscape	Landscape	Landscape	Landscape	Portrait
Pole length:	80 cm	80 cm	80 cm	80 cm	80 cm	80 cm
Colour (VESA arms):	Black	Black	Black	Black	Black	Black
Colour (Horizontal rail):	Black (Silver optional)	Black (Silver optional)	Black (Silver optional)	Black (Silver optional)	Black (Silver optional)	Black (Silver optional)
Colour (Poles & ceiling mount):	Black	Black	Black	Black	Black	Black
Warranty:	5 years	5 years	5 years	5 years	5 years	5 years
Accessories:	Cover plates	Cover plates	Cover plates	Cover plates	Cover plates	Cover plates



Menuboard with Gravity Center

A robust and innovative ceiling pole designed to securely hang displays by aligning with their natural center of gravity.

This unique design ensures straighter and more stable installations, especially for larger or heavier displays.

By angling the column to match the display's center of gravity with the mounting point, it reduces stress on the coupler joint, preventing unwanted movement or disruption of the column.



Model: Extension Pipe 0.915m Gravity Center

EAN: 735010521 3649

Colour: Black

Material: Plastic and aluminum

Weight: 2,5 kg

Measurements: 96 x 5.5 x 25.5 cm

Pole length: 0,915 m

Warranty: 5 years

MBC3X1UGC



MBC4X1UGC

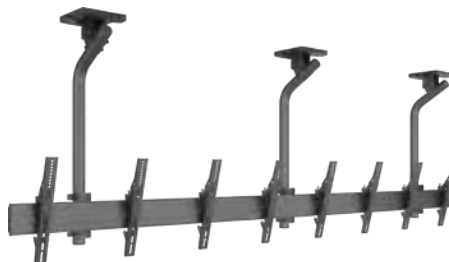

MBC5X1UGC

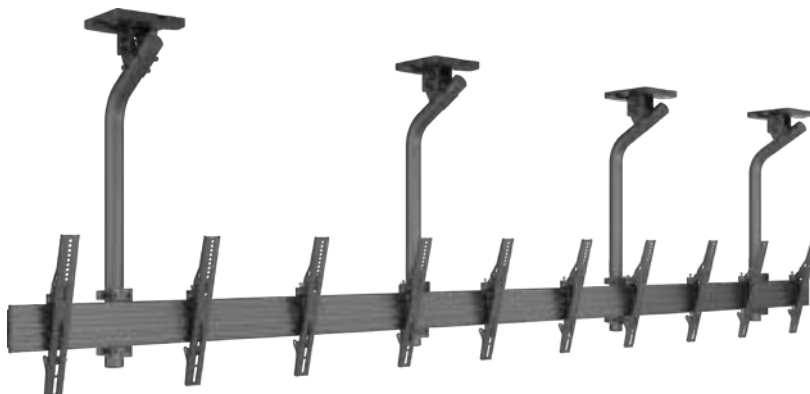

Model:	MBC3X1UGC	MBC4X1UGC	MBC5X1UGC
Screen size:	40"-65"	40"-65"	40"-65"
VESA:	VESA 400, 40cm	VESA 400, 40cm	VESA 400, 40cm
EAN:	735010521 8972	735010521 8989	735010521 8996
Max load:	30kg (Per screen)	30kg (Per screen)	30kg (Per screen)
Bracket type:	Tilt (Fixed optional)	Tilt (Fixed optional)	Fixed
Landscape / portrait:	Landscape	Landscape	Landscape
Pole length:	80 cm up to 150 cm	80 cm up to 150 cm	80 cm up to 150 cm
Colour (VESA arms):	Black	Black	Black
Colour (Horizontal rail):	Black (Silver optional)	Black (Silver optional)	Black (Silver optional)
Colour (Pillar):	Black	Black	Black
Warranty:	5 years	5 years	5 years
Accessories:	Cover plates	Cover plates	Cover plates

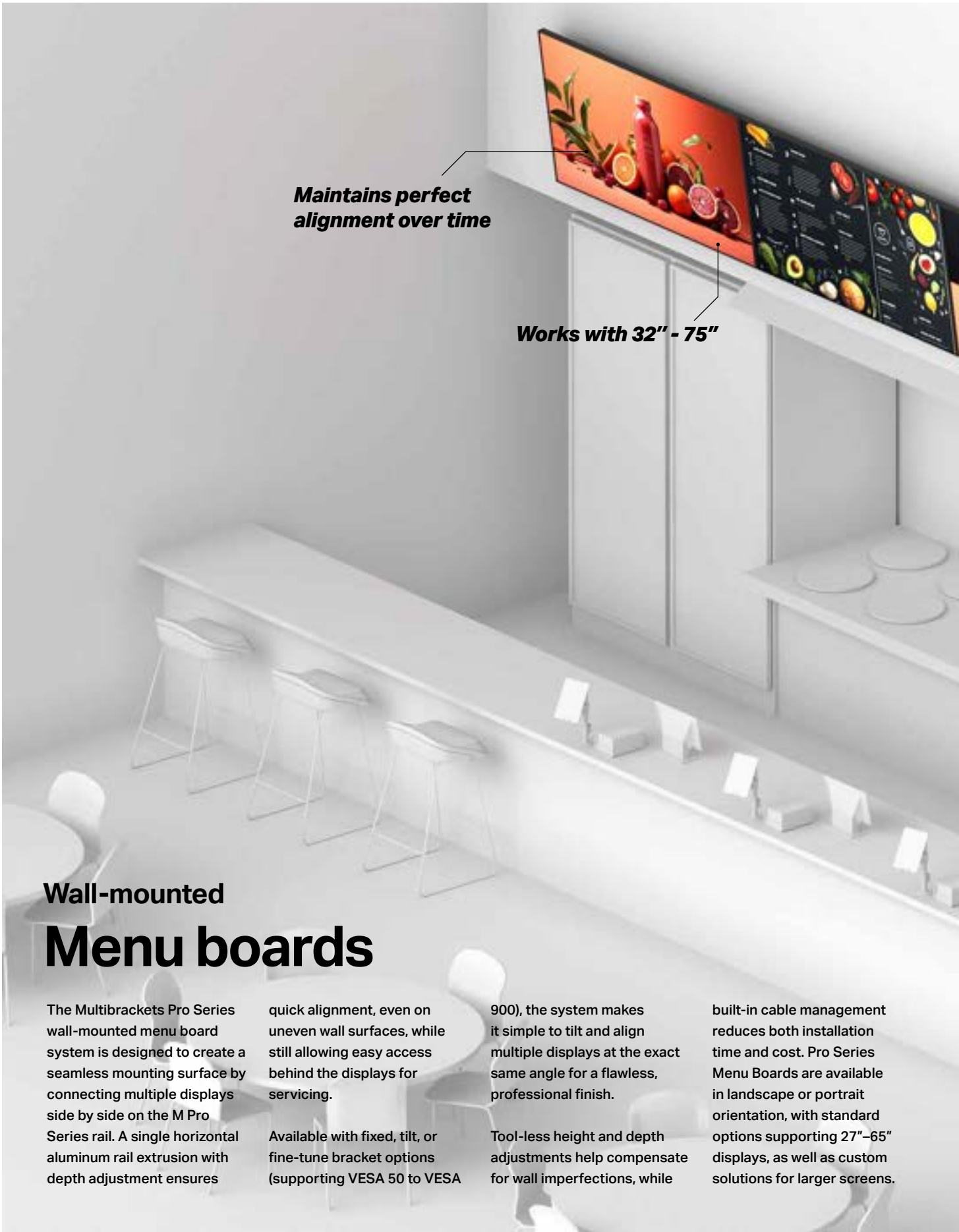

Maintains perfect alignment over time

Works with 32" - 75"

Wall-mounted Menu boards

The Multibrackets Pro Series wall-mounted menu board system is designed to create a seamless mounting surface by connecting multiple displays side by side on the M Pro Series rail. A single horizontal aluminum rail extrusion with depth adjustment ensures

quick alignment, even on uneven wall surfaces, while still allowing easy access behind the displays for servicing.

Available with fixed, tilt, or fine-tune bracket options (supporting VESA 50 to VESA

900), the system makes it simple to tilt and align multiple displays at the exact same angle for a flawless, professional finish.

Tool-less height and depth adjustments help compensate for wall imperfections, while

built-in cable management reduces both installation time and cost. Pro Series Menu Boards are available in landscape or portrait orientation, with standard options supporting 27"–65" displays, as well as custom solutions for larger screens.

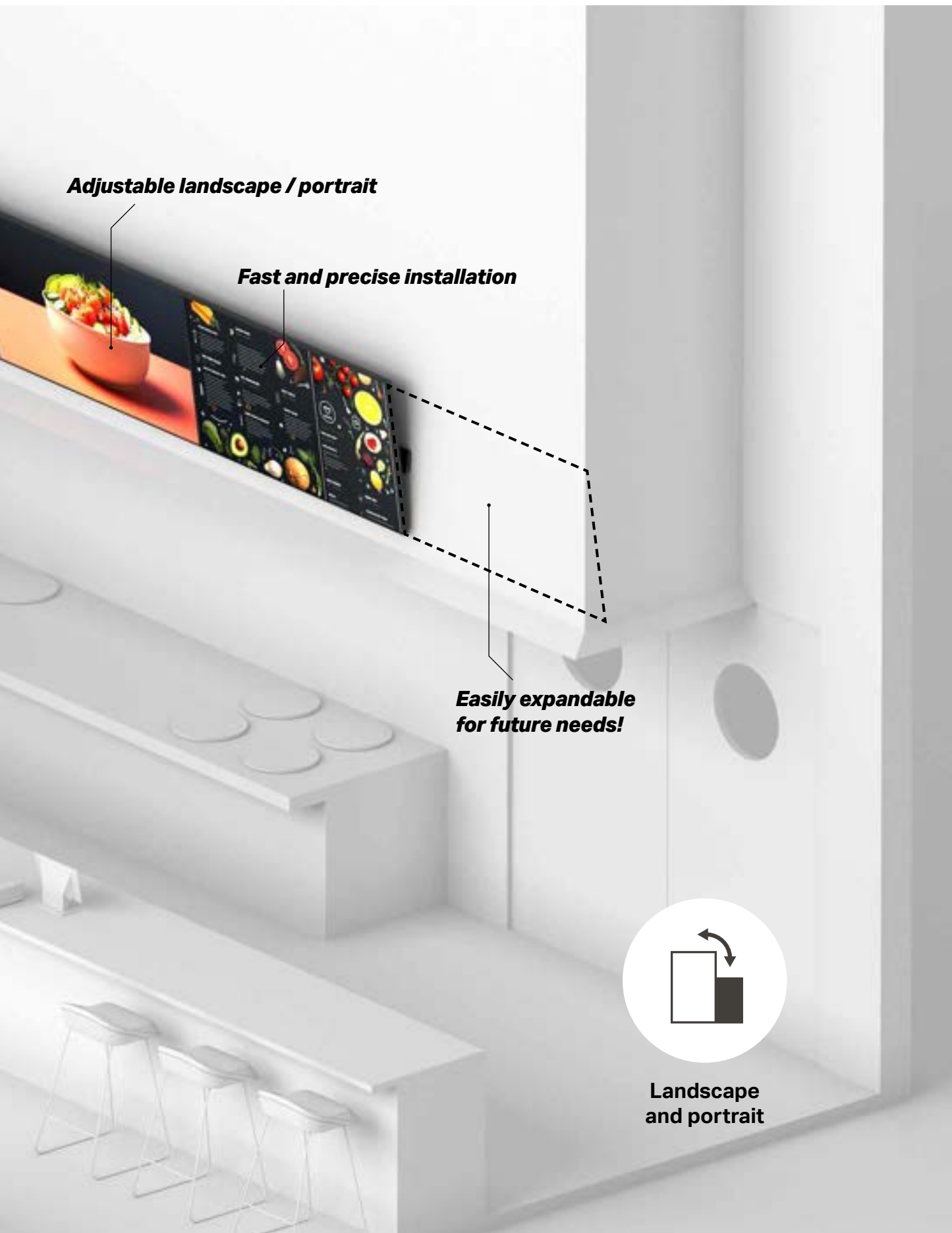

Adjustable landscape / portrait

Fast and precise installation

**Easily expandable
for future needs!**

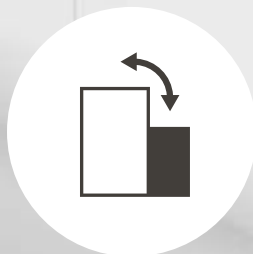

**Landscape
and portrait**

MBW2U Tilt 75/100

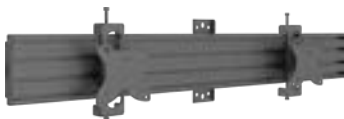

MBW3U Tilt 75/100



MBW1U Tilt 200



MBW2U Tilt 200



MBW3U Tilt 200



MBW4X1U Tilt VESA 300



Model:	MBW2U Tilt 75/100	MBW3U Tilt 75/100	MBW1U Tilt 200	MBW2U Tilt 200	MBW3U Tilt 200	MBW4X1U Tilt VESA 300
Screen size:	15" - 32"	15" - 32"	24" - 43"	24" - 43"	24" - 43"	32" - 50"
VESA:	75x75, 100x100	75x75, 100x100	VESA 200, 20cm	VESA 200, 20cm	VESA 200, 20cm	VESA 300, 30cm
EAN:	735010521 6725	735010521 6732	735007373 7024	735007373 7031	735007373 7048	735010521 6046
Max load:	10 kg (Per screen)	10 kg (Per screen)	30kg	30kg	30kg	50kg (Per screen)
Bracket type:	Tilt (Fixed optional)	Tilt (Fixed optional)	Tilt (Fixed optional)	Tilt (Fixed optional)	Tilt (Fixed optional)	Tilt (Fixed optional)
Landscape / portrait:	Yes	Yes	Landscape	Landscape	Landscape	Landscape
Wall distance:	77.5 mm	77.5 mm	56 mm	56 mm	56 mm	56 mm
Colour (VESA arms):	Black	Black	Black	Black	Black	Black
Colour (Horizontal rail):	Black	Black	Black	Black	Black	Black
Warranty:	5 years	5 years	5 years	5 years	5 years	5 years

MBW2X1U 400



MBC3X1U 400



MBC3X1UP 400

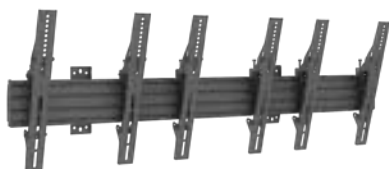

MBC4X1UP 400



MBW3U Micro Adjustable Black



Micro-adjustable

MBW4UP Micro Adjustable Black



	MBW2X1U 400	MBC3X1U 400	MBC3X1UP 400	MBC4X1UP 400	MBW3U Micro Adjustable	MBW4UP Micro Adjustable
Model:	MBW2X1U 400	MBC3X1U 400	MBC3X1UP 400	MBC4X1UP 400	MBW3U Micro Adjustable	MBW4UP Micro Adjustable
Screen size:	32" - 65"	32" - 65"	32" - 65"	32" - 65"	32" - 75"	32" - 75"
VESA:	VESA 400, 40cm	VESA 400, 40cm	VESA 400, 40cm	VESA 400, 40cm	VESA 400, 40cm	VESA 400, 40cm
EAN:	735007373 4061	735007373 4078	735007373 4061 +735007373 3743	735007373 4078 +735007373 3743	735010521 0648	735007373 0186
Max load:	30kg (Per screen)	30kg (Per screen)	30kg (Per screen)	30kg (Per screen)	50 kg (Per screen)	35 kg (Per screen)
Bracket type:	Tilt (Fixed optional)	Tilt (Fixed optional)	Tilt (Fixed optional)	Tilt (Fixed optional)	Micro Adjustable	Micro Adjustable
Landscape / portrait:	Landscape	Landscape	Landscape	Landscape	Yes	Yes
Wall distance:	56 mm	56 mm	56 mm	56 mm	58 mm	73 mm
Colour (VESA arms):	Black	Black	Black	Black	Black	Black
Colour (Horizontal rail):	Black	Black	Black	Black	Black	Black
Warranty:	5 years	5 years	5 years	5 years	5 years	5 years

**New model:**

MBFC1UD: 735007373 7734

(As shown on picture)

Floor-to-Ceiling Mount Solutions

Our floor-to-ceiling systems make it possible to install menu boards in prominent locations where traditional walls aren't available. They also provide an elegant solution in spaces where ceilings or walls cannot support the weight of a display.

As in-store digital signage continues to grow as one of the fastest expanding sectors

of the POS market, these mounts deliver both stability and style. With their modern design and clean, eye-catching appearance, floor-to-ceiling solutions not only provide flexibility but also serve as an immediate focal point in any environment.

MBFC1U 200



MBFC2U 200



MBFC1U



MBFC1U Brass



MBFC1U Chrome



MBFC1U White



	MBFC1U 200	MBFC2U 200	MBFC1U	MBFC1U Brass	MBFC1U Chrome	MBFC1U White
Model:	MBFC1U 200	MBFC2U 200	MBFC1U	MBFC1U Brass	MBFC1U Chrome	MBFC1U White
Screen size:	24"-32"	24"-32"	32" - 65"	32" - 65"	32" - 65"	32" - 65"
VESA:	VESA 200, 20cm	VESA 200, 20cm	VESA 400, 40cm	VESA 400, 40cm	VESA 400, 40cm	VESA 400, 40cm
EAN:	734023481 0468	734023481 0475	735007373 3620	735007373 5709	735007373 5693	735007373 5686
Max load:	50kg	30kg (Per screen)	30kg (Per screen)	30kg (Per screen)	30kg (Per screen)	30kg (Per screen)
Bracket type:	Fixed	Fixed	Fixed	Fixed	Fixed	Fixed
Landscape / portrait:	Yes	Yes	Yes	Yes	Yes	Yes
Pole length:	150 cm up to 300 cm	150 cm up to 300 cm	150 cm up to 300 cm	150 cm up to 300 cm	150 cm up to 300 cm	150 cm up to 300 cm
Colour (VESA arms):	Black	Black	Black	Black	Black	Black
Colour (Horizontal rail):	Black (Silver optional)	Black (Silver optional)	Black (Silver optional)	Black (Silver optional)	Black (Silver optional)	Black (Silver optional)
Colour (Poles & ceiling mount):	Black	Black	Black	Black	Black	Black
Warranty:	5 years	5 years	5 years	5 years	5 years	5 years
Accessories:	Cover plates	Cover plates	Cover plates	Cover plates	Cover plates	Cover plates

MBFCUP 600

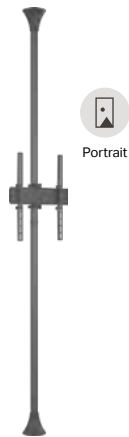

MBFC2UP 600



MBFC2U Brass



MBFC2U Chrome



	MBFCUP 600	MBFC2UP 600	MBFC3U Brass	MBFC1U Chrome
Model:	MBFCUP 600	MBFC2UP 600	MBFC3U Brass	MBFC1U Chrome
Screen size:	55"-86"	55"-86"	32" - 65"	32" - 65"
VESA:	Max 400x600mm	Max 400x600mm	VESA 400, 40cm	VESA 400, 40cm
EAN:	735010521 9931	735010521 9924	735007373 5730	735007373 5723
Max load:	30kg	30kg (Per screen)	30kg (Per screen)	30kg (Per screen)
Bracket type:	Fixed	Fixed	Fixed	Fixed
Landscape / portrait:	Portrait	Portrait	Yes	Yes
Pole length:	150 cm up to 300 cm	150 cm up to 300 cm	150 cm up to 300 cm	150 cm up to 300 cm
Colour (VESA arms):	Black	Black	Black	Black
Colour (Horizontal rail):	Black (Silver optional)	Black (Silver optional)	Black (Silver optional)	Black (Silver optional)
Colour (Poles & ceiling mount):	Black	Black	Black	Black
Warranty:	5 years	5 years	5 years	5 years
Accessories:	Cover plates	Cover plates	Cover plates	Cover plates

MBFC1U Turn

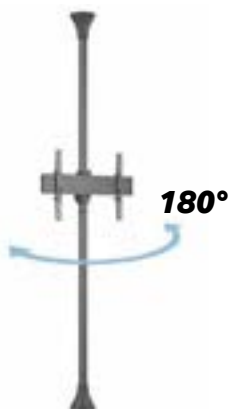

MBFC1U Turn Brass

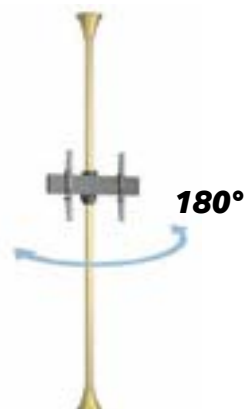

MBFC1U Turn Chrome

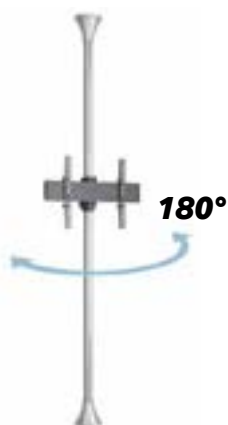

MBFC1U Turn White

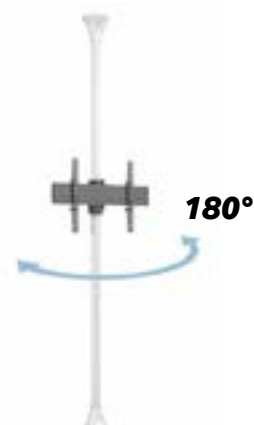

	MBFC1U Turn	MBFC1U Turn Brass	MBFC1U Turn Chrome	MBFC1U Turn White
Model:	MBFC1U Turn	MBFC1U Turn Brass	MBFC1U Turn Chrome	MBFC1U Turn White
EAN:	734023481 2455	734023481 2462	734023481 2479	734023481 2486
Screen size:	40"-65"	40"-65"	40"-65"	40"-65"
Type:	Single Side MBFC1U	Single Side MBFC1U	Single Side MBFC1U	Single Side MBFC1U
VESA:	Adjustable from 100x100 to 600x400 max Optional VESA 800x600	Adjustable from 100x100 to 600x400 max Optional VESA 800x600	Adjustable from 100x100 to 600x400 max Optional VESA 800x600	Adjustable from 100x100 to 600x400 max Optional VESA 800x600
Material:	Steel, Aluminium	Steel, Aluminium	Steel, Aluminium	Steel, Aluminium
Color:	Black	Brass	Chrome	Chrome
Surface Finish:	Powder coating / Anodic Oxidation	Powder coating / Anodic Oxidation	Powder coating / Anodic Oxidation	Powder coating / Anodic Oxidation
Weight:	13,5 kg	13,5 kg	13,5 kg	13,5 kg
Measurements	155.5x21x16.8cm	155.5x21x16.8cm	155.5x21x16.8cm	155.5x21x16.8cm
Max Load:	30 kg per screen	30 kg per screen	30 kg per screen	30 kg per screen
Pillar length:	Min: 580mm to Max: 1550 mm From ceiling to VESA plate center Extension pipes: 3m (1500mm*2pcs) included	Min: 580mm to Max: 1550 mm From ceiling to VESA plate center Extension pipes: 3m (1500mm*2pcs) included	Min: 580mm to Max: 1550 mm From ceiling to VESA plate center Extension pipes: 3m (1500mm*2pcs) included	Min: 580mm to Max: 1550 mm From ceiling to VESA plate center Extension pipes: 3m (1500mm*2pcs) included
Cable Management:	Yes	Yes	Yes	Yes
Options:	Extension pipes : 0.8m, 1.5m, 3.0m	Extension pipes : 0.8m, 1.5m, 3.0m	Extension pipes : 0.8m, 1.5m, 3.0m	Extension pipes : 0.8m, 1.5m, 3.0m
Certifications:	CE	CE	CE	CE
Warranty:	Warranty	Warranty	Warranty	Warranty

MBFC1F VESA 200

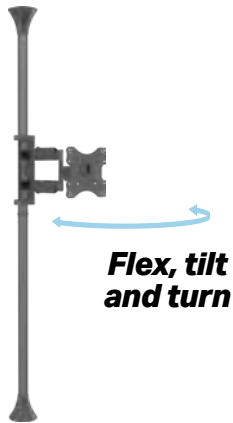

MBFC1F



MBFC1FP



	MBFC1F VESA 200	MBFC1F	MBFC1FP
Model:	MBFC1F VESA 200	MBFC1F	MBFC1FP
Screen size:	17" - 42"	42" - 55"	50" - 70"
VESA:	VESA 200, 20cm	VESA 400, 40cm	VESA 600, 60cm
EAN:	735007373 6393	735007373 6409	735010521 2505
Max load:	35kg (Per screen)	35kg (Per screen)	35kg (Per screen)
Bracket type:	Tilt	Tilt	Tilt
Landscape / portrait:	Yes	Yes	Yes
Pole length:	580 cm up to 300 cm	580 cm up to 300 cm	580 cm up to 300 cm
Colour (VESA arms):	Black	Black	Black
Colour (Horizontal rail):	Black (Silver optional)	Black (Silver optional)	Black (Silver optional)
Colour (Poles & ceiling mount):	Black/ Brass/Chrome/ White	Black/ Brass/Chrome/ White	Black/ Brass/Chrome/ White
Warranty:	5 years	5 years	5 years
Accessories:	Cover plates	Cover plates	Cover plates

MBFC2UX2

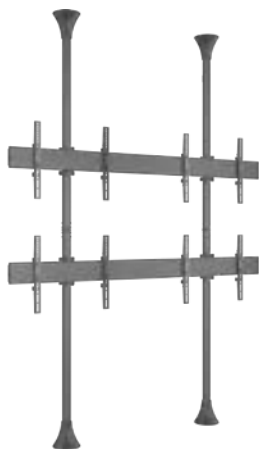

MBFC2UX3

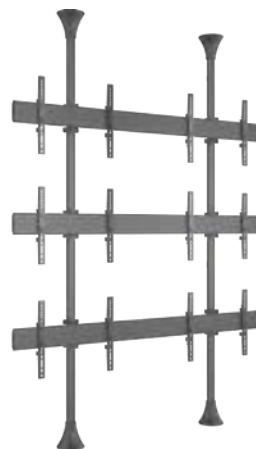

MBFC3UX2

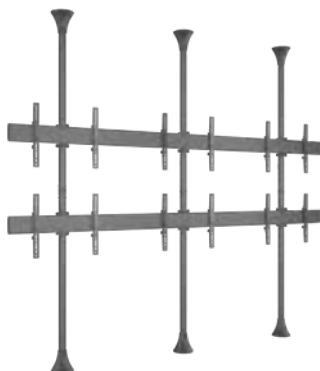

MBFC3UX3

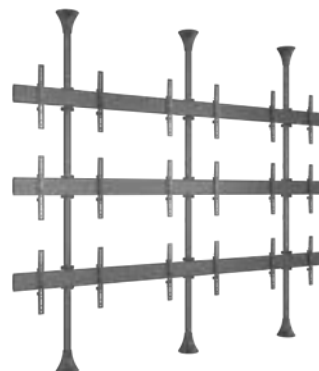

	MBFC2UX2	MBFC2UX3	MBFC3UX2	MBFC3UX3
Model:	MBFC2UX2	MBFC2UX3	MBFC3UX2	MBFC3UX3
Screen size:	40" - 65"	40" - 65"	40" - 65"	40" - 65"
VESA:	VESA400 ,40cm	VESA400 ,40cm	VESA400, 40cm	VESA400, 40cm
EAN:	735010521 6084	735010521 6091	735010521 6107	735010521 6114
Max load:	30kg (Per screen)	30kg (Per screen)	30kg (Per screen)	30kg (Per screen)
Bracket type:	Fixed (Tilt optional)	Fixed (Tilt optional)	Fixed (Tilt optional)	Fixed (Tilt optional)
Landscape / portrait:	Yes	Yes	Yes	Yes
Pole length:	80 cm up to 300 cm	80 cm up to 300 cm	150 cm up to 300 cm	150 cm up to 300 cm
Colour (VESA arms):	Black	Black	Black	Black
Colour (Horizontal rail):	Black (Silver optional)	Black (Silver optional)	Black (Silver optional)	Black (Silver optional)
Colour (Poles & ceiling mount):	Black	Black	Black	Black
Warranty:	5 years	5 years	5 years	5 years
Accessories:	Cover plates	Cover plates	Cover plates	Cover plates

MBFC2X3U



MBFC3UX3 Micro Adjustable

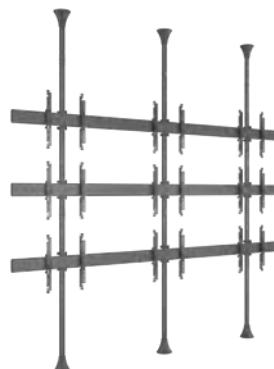

MBFC3X3U

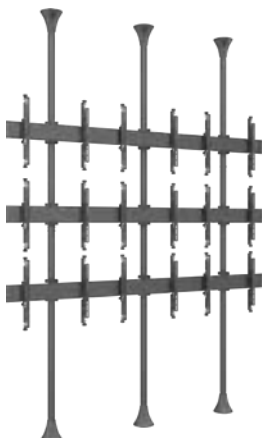

MBFC7UX3 Micro Adjustable

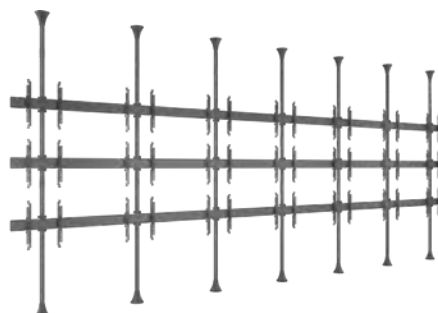

	MBFC2X3U	MBFC3UX3 Micro Adjustable	MBFC3X3U	MBFC7UX3 MicroAdjustable
Model:	MBFC2X3U	MBFC3UX3 Micro Adjustable	MBFC3X3U	MBFC7UX3 MicroAdjustable
Screen size:	32" - 65"	40" - 65"	32" - 65"	40" - 65"
VESA:	VESA 400, 40cm	VESA400, 40cm	VESA 400, 40cm	VESA400, 40cm
EAN:	735007373 4986	735010521 6657	735007373 4933	735010521 6664
Max load:	30kg (Per screen)	30kg (Per screen)	30kg (Per screen)	30kg (Per screen)
Bracket type:	Micro-Adjustable Arms	Micro-Adjustable Arms	Micro-Adjustable Arms	Micro-Adjustable Arms
Landscape / portrait:	Yes	Yes	Yes	Portrait
Pole length:	150 cm up to 300 cm	150 cm up to 390 cm	150 cm up to 300 cm	150 cm up to 390 cm
Colour (VESA arms):	Black	Black	Black	Black
Colour (Horizontal rail):	Black (Silver optional)	Black (Silver optional)	Black (Silver optional)	Black (Silver optional)
Colour (Poles & ceiling mount):	Black/ Brass/ Chrome/ White	Black	Black/ Brass/ Chrome/ White	Black
Warranty:	5 years	5 years	5 years	5 years
Accessories:	Cover plates	Cover plates	Cover plates	Cover plates

M Floor to Ceiling Mount Pro MBFC7UX5

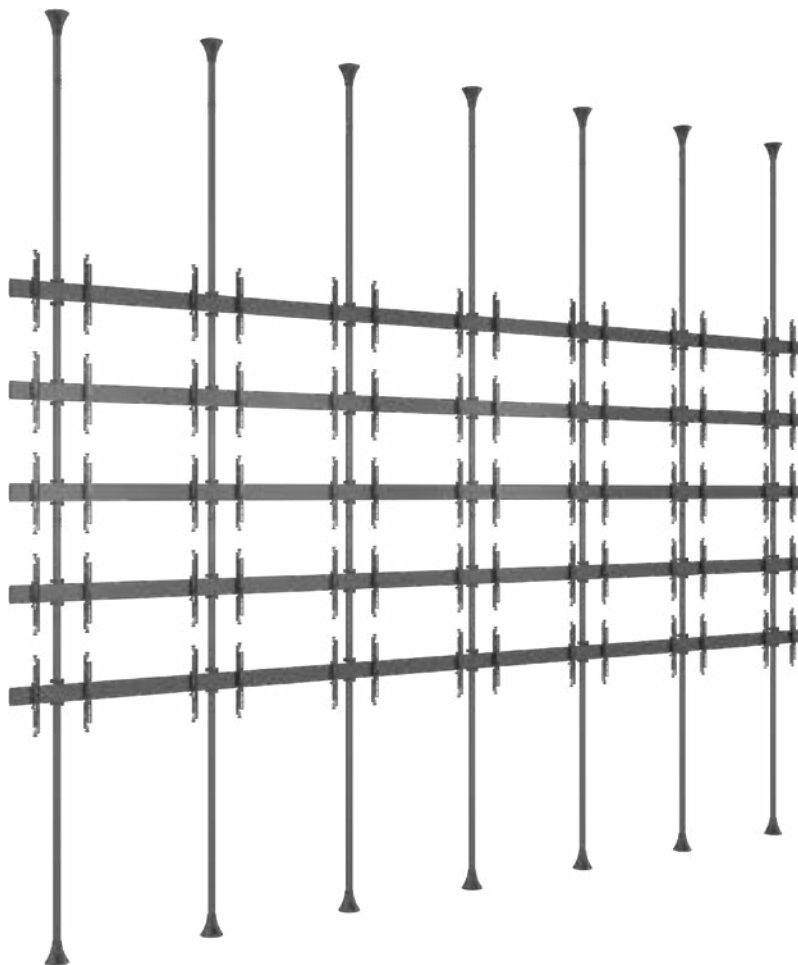

Floor-to-Ceiling Mount Solutions

Our floor-to-ceiling systems make it possible to install menu boards in prominent locations where traditional walls aren't available. They also provide an elegant solution in spaces where ceilings or walls cannot support the weight of a display.

As in-store digital signage continues to grow as one of the fastest expanding sectors

of the POS market, these mounts deliver both stability and style. With their modern design and clean, eye-catching appearance, floor-to-ceiling solutions not only provide flexibility but also serve as an immediate focal point in any environment.

Model:	M Floor to Ceiling Mount Pro MBFC7UX5
Screen size:	40" - 65"
VESA:	VESA 400, 40cm
EAN:	735002273 8737
Max load:	30kg (Per screen)
Bracket type:	Micro-Adjustable Arms
Landscape / portrait:	Landscape
Pole length:	150 cm up to 690 cm
Colour (VESA arms):	Black
Colour (Horizontal rail):	Black (Silver optional)
Colour (Pillar):	Black
Warranty:	5 years

MBFC2X2U-F100

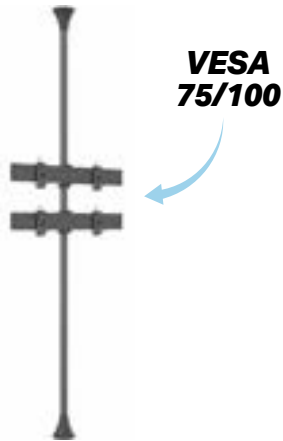

MBFC3x2U-F100



MBFC3x3U-F100

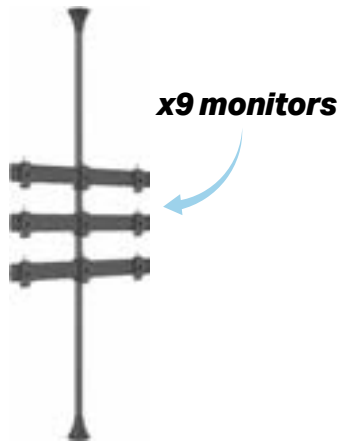

MBFC3x4U-F100



	MBFC2X2U-F100	MBFC3x2U-F100	MBFC3x3U-F100	MBFC3x4U-F100
Model:	MBFC2X2U-F100	MBFC3x2U-F100	MBFC3x3U-F100	MBFC3x4U-F100
Screen size:	15" - 32"	15" - 32"	15" - 32"	15" - 32"
VESA:	50 / 75 / 100mm	50 / 75 / 100mm	50 / 75 / 100mm	50 / 75 / 100mm
EAN:	735010521 2000	735010521 2017	735010521 2024	735010521 2031
Max load:	10kg (Per screen)	10kg (Per screen)	10kg (Per screen)	10kg (Per screen)
Bracket type:	Fixed (Tilt optional)	Fixed (Tilt optional)	Fixed (Tilt optional)	Fixed (Tilt optional)
Landscape / portrait:	Yes	Yes	Yes	Yes
Pole length:	80 cm up to 300 cm	80 cm up to 300 cm	80 cm up to 300 cm	80 cm up to 300 cm
Colour (VESA arms):	Black	Black	Black	Black
Colour (Horizontal rail):	Black (Silver optional)	Black (Silver optional)	Black (Silver optional)	Black (Silver optional)
Colour (Poles & ceiling mount):	Black	Black	Black	Black
Warranty:	5 years	5 years	5 years	5 years
Accessories:	Cover plates	Cover plates	Cover plates	Cover plates



Pro Series

Hospitality products

As A/V solutions evolve, it's essential to use the right hardware and services to unlock their full potential. Our hospitality solutions are designed for hotels, restaurants, bars, and sports arenas — helping you create engaging experiences and keeping your guests satisfied.

Hotel rooms
Bar/ Restaurant
Conference room
Guest Room
Gym/ Spa
Lobby
Reception/ Desk
Health Care Room

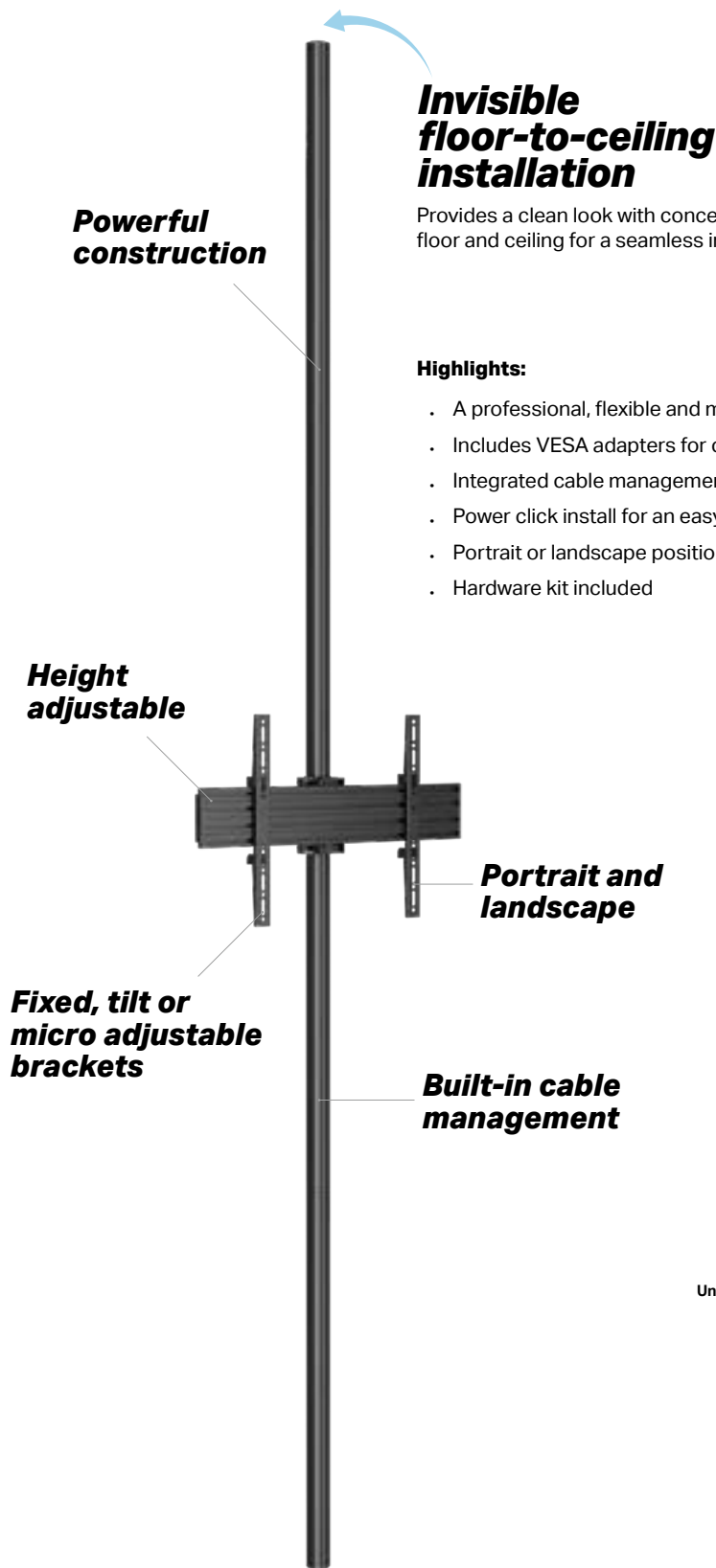

Invisible floor-to-ceiling installation

Provides a clean look with concealed fixtures between floor and ceiling for a seamless installation.

Highlights:

- A professional, flexible and modular product
- Includes VESA adapters for compatibility up to VESA 600x400
- Integrated cable management throughout the entire solution
- Power click install for an easy, fast and safe installation
- Portrait or landscape position of screen possible
- Hardware kit included

Model: MBFC1UD

EAN: 735007373 7734

Screen size: 40"-65"

Type: Single Side MBFC1U

Universal & VESA standard: 100x100,200x200,300x300,400x400

Material: Steel, Aluminium

Color: Black

Surface Finish: Powder coating

Weight: 13 kg

Measurements: 49x17.4x300 cm

Max Load: 30 kg per screen

Pillar length: 3000 mm from ceiling to VESA plate center

Cable Management: Yes

Options: Extension pipes : 0.8m, 1.5m, 3.0m

Certifications: CE

Warranty: 5 years

Large Screens

Floor to Ceiling Mounts

In-store digital signage is one of the fastest-growing sectors of the POS market.

MBFC1UX1 800



MBFC1UX1 1000

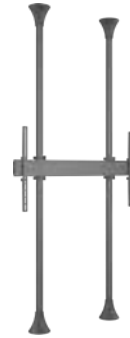

MBFC1UX1 1000 White



MBFC1UX1 1600

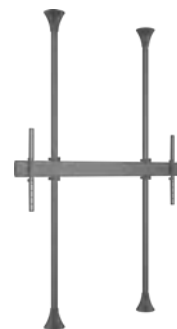

	MBFC1UX1 800	MBFC1UX1 1000	MBFC1UX1 1000 White	MBFC1UX1 1600
Model:	MBFC1UX1 800	MBFC1UX1 1000	MBFC1UX1 1000 White	MBFC1UX1 1600
Screen size:	55" - 70"	55" - 85"	65"-100"	85" - 110"
VESA:	800x600mm	1000x600mm	Max 1000x600mm	1600x600mm
EAN:	735010521 7401	735010521 7395	735002273 8027	735010521 7388
Max load:	125kg	125kg	125kg	125kg
Bracket type:	Fixed (Tilt optional)	Fixed (Tilt optional)	Fixed	Fixed (Tilt optional)
Landscape / portrait:	Yes	Yes	Yes	Yes
Pole length:	80 cm up to 300 cm	80 cm up to 300 cm	150 cm up to 300 cm	80 cm up to 300 cm
Colour (VESA arms):	Black	Black	Black	Black
Colour (Horizontal rail):	Black (Silver optional)	Black (Silver optional)	Black (Silver optional)	Black (Silver optional)
Colour (Poles & ceiling mount):	Black	Black	Black	Black
Warranty:	5 years	5 years	5 years	5 years
Accessories:	Cover plates	Cover plates	Cover plates	Cover plates

MBFC1UHD

Single landscape



MBFC2UHD

Back to back possibility

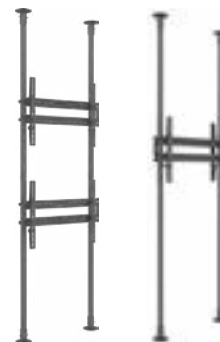

MBFC1UPHD

Single portrait



MBFC2UPD

Back to back possibility



	MBFC1UHD	MBFC2UHD	MBFC1UPHD	MBFC2UPHD
Model:	MBFC1UHD	MBFC2UHD	MBFC1UPHD	MBFC2UPHD
Screen size:	50" - 90"	50" - 90"	50" - 90"	50" - 90"
VESA:	VESA 800, 80cm	VESA 800, 80cm	VESA 900, 90cm	VESA 900, 90cm
EAN:	735007373 7932	735007373 7949	735007373 7956	735007373 7963
Max load:	80kg (Per screen)	80kg (Per screen)	80kg (Per screen)	80kg (Per screen)
Bracket type:	Pole bracket 800x600	Pole bracket 800x600	Pole bracket 600x900	Pole bracket 600x900
Landscape / portrait:	Landscape	Landscape	Portrait	Portrait
Pole length:	310 cm	310 cm	310 cm	310 cm
Colour (VESA arms):	Black	Black	Black	Black
Colour (Horizontal rail):	Black (Silver optional)	Black (Silver optional)	Black (Silver optional)	Black (Silver optional)
Colour (Poles & ceiling mount):	Black	Black	Black	Black
Warranty:	5 years	5 years	5 years	5 years
Accessories:	Cover plates	Cover plates	Cover plates	Cover plates



Pro Series Floor-to-Wall Mounts

The M Floor to Wall Mount provides a rock-steady display solution designed for retail stores, shopping malls, and other public spaces. Using 50 mm tubes in black, brass, or chrome, the system can be tailored to seamlessly fit its surroundings.

Screens can be mounted in either fixed or tilt positions, and multiple displays can be placed side by side or stacked vertically to create the perfect setup for any environment.

Large screens

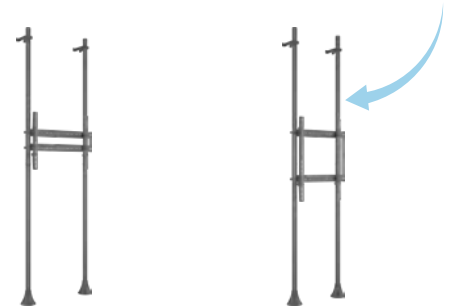

	Model: MBFW2P1UHD	MBFW2P1UPHD
Screen size:	65" - 100"	65" - 100"
VESA:	800x600mm	600x900mm
EAN:	735010521 6015	735010521 6022
Max load:	125kg	125kg
Bracket type:	Fixed (Tilt optional)	Fixed (Tilt optional)
Landscape / portrait:	Portrait	Yes
Pole length:	80 cm up to 300 cm	80 cm up to 300 cm
Colour (VESA arms):	Black	Black
Colour (Horizontal rail):	Black (Silver optional)	Black (Silver optional)
Colour (Poles & ceiling mount):	Black	Black
Warranty:	5 years	5 years
Accessories:	Cover plates	Cover plates

MBFW1U



MBFW2U



MBFW3U



MBFW3U2U

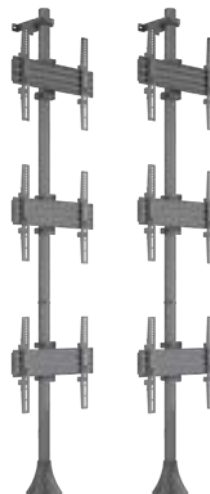

	MBFW1U	MBFW2U	MBFW3U	MBFW3U2U
Model:	MBFW1U	MBFW2U	MBFW3U	MBFW3U2U
Screen size:	32" - 65"	32" - 65"	32" - 65"	32" - 65"
VESA:	VESA400, 40cm	VESA400, 40cm	VESA400, 40cm	VESA400, 40cm
EAN:	735010521 4141	735010521 4158	735010521 4165	735010521 4165 (x2)
Max load:	30kg (Per screen)	30kg (Per screen)	30kg (Per screen)	30kg (Per screen)
Bracket type:	Fixed	Fixed	Fixed	Fixed
Landscape / portrait:	Yes	Yes	Yes	Yes
Pole length:	150 cm up to 300 cm	150 cm up to 300 cm	150 cm up to 300 cm	150 cm up to 300 cm
Colour (VESA arms):	Black	Black	Black	Black
Colour (Horizontal rail):	Black (Silver optional)	Black (Silver optional)	Black (Silver optional)	Black (Silver optional)
Colour (Poles & ceiling mount):	Black / Brass / Chrome / White	Black / Brass / Chrome / White	Black / Brass / Chrome / White	Black / Brass / Chrome / White
Warranty:	5 years	5 years	5 years	5 years
Accessories:	Cover plates	Cover plates	Cover plates	Cover plates

M Wall to Wall Mount Pro MBWW1U

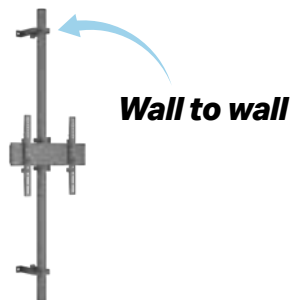

M Wall to Wall Mount Pro 3m MBWW1U



M Wall to Wall Mount Pro MBWW2U



M Wall to Wall Mount Pro 3m MBWW2U



Model:	M Wall to Wall Mount Pro MBWW1U	M Wall to Wall Mount Pro 3m MBWW1U	M Wall to Wall Mount Pro MBWW2U	M Wall to Wall Mount Pro 3m MBWW2U
Screen size:	40"-65"	40"-65"	40"-65"	40"-65"
VESA:	VESA 400, 40cm	VESA 400, 40cm	VESA 400, 40cm	VESA 400, 40cm
EAN:	735010521 8279	735010521 8286	735010521 8286	735010521 8286
Max load:	45kg	45kg	30kg (Per screen)	30kg (Per screen)
Bracket type:	Fixed	Fixed	Fixed	Fixed
Landscape / portrait:	Yes	Yes	Yes	Yes
Pillar length:	150 cm	300 cm	150 cm	300 cm
Colour (VESA arms):	Black	Black	Black	Black
Colour (Horizontal rail):	Black (Silver optional)	Black (Silver optional)	Black (Silver optional)	Black (Silver optional)
Colour (Pillar):	Black	Black	Black	Black
Warranty:	5 years	5 years	5 years	5 years

M Wall to Wall Mount Pro MBWW1U



M Wall to Wall Mount Pro 3m MBWW1U



M Wall to Wall Mount Pro MBWW2U



M Wall to Wall Mount Pro 3m MBWW2U



M Wall to Wall Mount Pro 3m MBWW2U

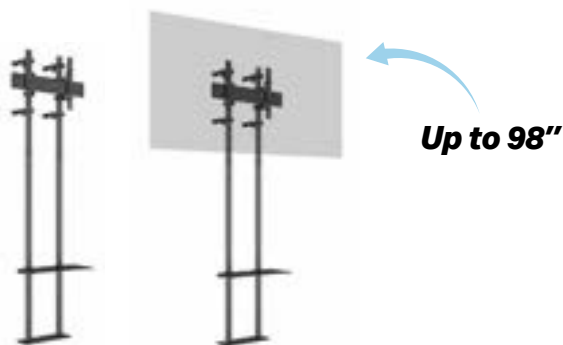

Model:	M Floor to Wall Mount Pro MBFW1U VESA 600	M Pro Series - Floor to Wall Mount Pro 32" - 65"	M Pro Series - Floor to Wall Mount Pro MBFW1U AV shelf	M Pro Series - Floor to Wall Mount Pro 75" - 98"	M Floor to Wall Mount Pro MBFW2P1UHD AV shelf
Screen size:	40"-75"	32"-65"	32"-65"	75"-98"	75"-98"
VESA:	VESA 600	VESA 400	VESA 400	VESA 400	VESA 400
EAN:	734023481 1519	734023481 2592	734023481 1939	734023481 2615	734023481 2042
Max load:	50 kg per screen	50 kg per screen (AV shelf: 5kg)	50 kg per screen (AV shelf: 5kg)	50 kg per screen (AV shelf: 5kg)	100 kg (AV shelf: 5kg)
Bracket type:	Fixed	Tilt	Tilt	Fixed	Fixed
Landscape / portrait:	Yes	Yes	Yes	Yes	Yes
Pole length:	150 cm	150 cm	150 cm	231.4 cm	231.4 cm
Colour (VESA arms):	Black	Black	Black	Black	Black
Colour (Horizontal rail):	Black (Silver optional)	Black (Silver optional)	Black (Silver optional)	Black (Silver optional)	Black (Silver optional)
Colour (Poles & ceiling mount):	Black	Black	Black	Black	Black
Warranty:	5 years	5 years	5 years	5 years	5 years



Pro Series

Wall-Mounted Solutions

Our Pro Series wall mounts are ideal for menu boards or digital signage installations, offering precise display positioning and flexible adjustment options.

The single horizontal extrusion, with optional push-in/pop-out and depth adjustment, ensures

fast alignment even on uneven wall surfaces. It also provides easy access behind the displays for quick and efficient servicing. For multi-screen installations, the Pro Series wall mounts provide a simple and reliable way to achieve perfect display positioning. Installers

can choose from a range of standardized bracket and adjustment solutions to suit their needs.

Using a single aluminum extrusion rail with fixed, tilt, or push-in/pop-out brackets, screens can be aligned quickly

and efficiently, ensuring the best possible installation experience.

Maximize flexibility

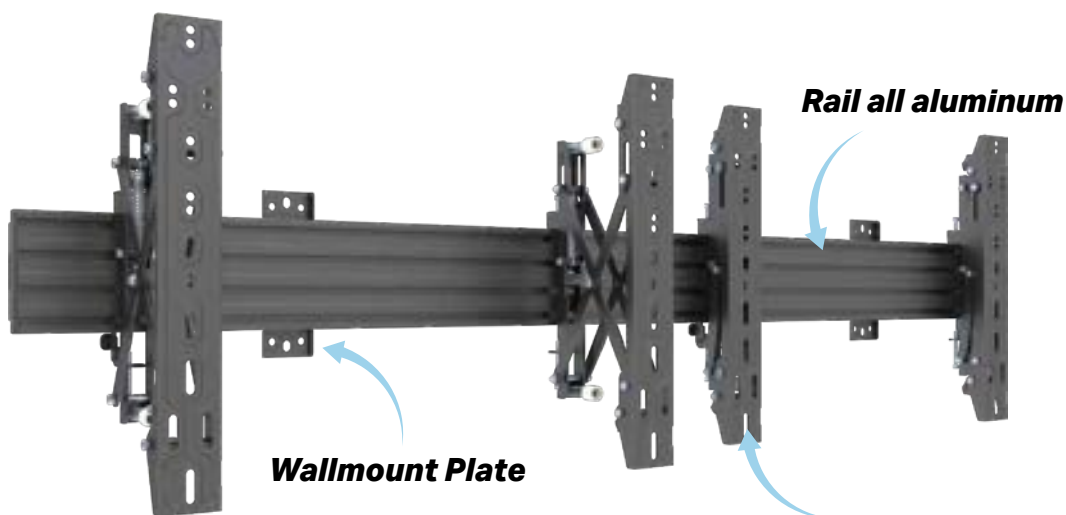

Exchangable Mounts
Fixed, Tilt, Micro adjustment
arms or Push in Pop out arms

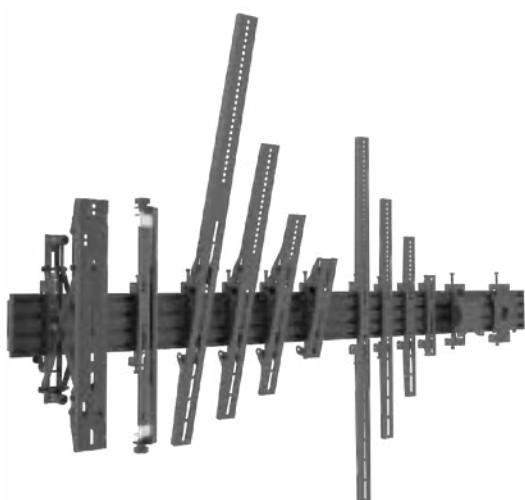

Choose between a wide variety of arms



VESA 200 / 300 / 400 / 600 / 900 / 1200 / 1600



Pro Series Wallmounts

The Multibrackets Pro Series Wallmount range is engineered for compact and reliable digital signage installations. Ideal for displaying dynamic content in retail, hospitality, transportation hubs, or corporate spaces, these mounts combine Scandinavian design with

professional performance. Built for efficiency and visual harmony, each model offers precise screen adjustment, integrated cable management, and quick installation, delivering a clean, modern presentation for any digital signage environment.

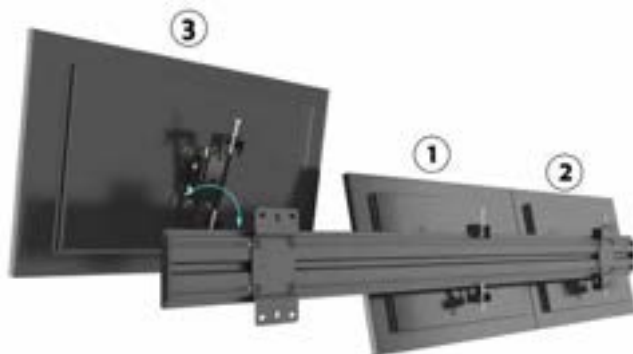

MBW1U Tilt 75/100



MBW2U Tilt 75/100



For monitors VESA 50/75/100

MBW3U Tilt 75/100



MBW4U Tilt 75/100



Model:	MBW1U Tilt 75/100	MBW2U Tilt 75/100	MBW3U Tilt 75/100	MBW4U Tilt 75/100
Screen size:	15"-32"	15"-32"	15"-32"	15"-32"
VESA:	75 / 100mm	75 / 100mm	75 / 100mm	75 / 100mm
EAN:	735010521 6718	735010521 6725	735010521 6732	734023481 3551
Max load:	10kg (Per screen)	10kg (Per screen)	10kg (Per screen)	10kg (Per screen)
Bracket type:	Tilt (Fixed optional)	Tilt (Fixed optional)	Fixed (Tilt optional)	Fixed (Tilt optional)
Landscape / portrait:	Yes	Yes	Yes	Yes
Wall distance:	9.3 cm	9.3 cm	9.3 cm	9.3 cm
Colour (VESA arms):	Black	Black	Black	Black
Colour (Horizontal rail):	Black (Silver optional)	Black (Silver optional)	Black (Silver optional)	Black (Silver optional)
Warranty:	5 years	5 years	5 years	5 years

MBW1U Fixed 200



MBSTH1U 400x200 Fixed

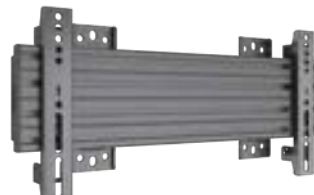

MBSTH1U 600x200 Fixed

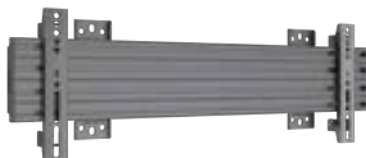

MBW2U Fixed 200

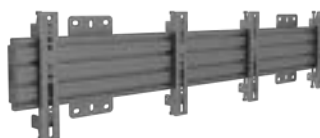

MBW3U Fixed 200

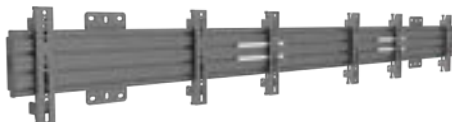

MBW1U Tilt 200



	Model: MBW1U Fixed 200	MBSTH1U 400x200 Fixed	MBSTH1U 600x200 Fixed	MBW2U Fixed 200	MBW3U Fixed 200	MBW1U Tilt 200
Screen size:	17" - 42"	40"-100"	40"-100"	27" - 42"	27" - 42"	17" - 42"
VESA:	VESA 200, 20cm	VESA 200, 20cm	VESA 200, 20cm	VESA 200, 20cm	VESA 200, 20cm	VESA 200, 20cm
EAN:	735007373 6997	735007373 7994	735007373 4306	735007373 7031	735007373 7048	735007373 7024
Max load:	30 kg	80 kg	80 kg	30 kg (Per screen)	30 kg (Per screen)	30 kg (Per screen)
Bracket type:	Fixed (Tilt optional)	Fixed	Fixed	Fixed (Tilt optional)	Fixed (Tilt optional)	Tilt (Fixed optional)
Landscape / portrait:	Yes	Portrait	Landscape	Yes	Yes	Yes
Wall distance:	5 cm	5 cm	5 cm	5 cm	5 cm	5,6 cm
Colour (VESA arms):	Black	Black	Black	Black	Black	Black
Colour (Horizontal rail):	Black / silver	Black (Silver optional)	Black (Silver optional)	Black / silver	Black / silver	Black / silver
Warranty:	5 years	5 years	5 years	5 years	5 years	5 years

MBW2U Tilt 200



MBW3U Tilt 200



MBW5U Tilt 200



MBW4U Tilt 200



	MBW2U Tilt 200	MBW3U Tilt 200	MBW5U Tilt 200	MBW4U Tilt 200
Model:	MBW2U Tilt 200	MBW3U Tilt 200	MBW5U Tilt 200	MBW4U Tilt 200
Screen size:	40" - 65"	40" - 65"	27"-32"	27"-32"
VESA:	VESA 400, 40cm	VESA 400, 40cm	VESA200, 20cm	VESA 200, 20cm
EAN:	735007373 4061	735007373 4078	735010521 5988	735010521 5971
Max load:	30 kg (Per screen)	30 kg (Per screen)	30kg (Per screen)	10kg (Per screen)
Bracket type:	Tilt	Tilt	Tilt (Fixed optional)	Tilt (Fixed optional)
Landscape / portrait:	Yes	Yes	Yes	Yes
Wall distance:	5,6 cm	5,6 cm	5.6cm	5.6 cm
Colour (VESA arms):	Black	Black	Black	Black
Colour (Horizontal rail):	Black (Silver optional)	Black (Silver optional)	Black (Silver optional)	Black (Silver optional)
Warranty:	5 years	5 years	5 years	5 years

MBW1U Fixed 300 Black



MBW1U Fixed 300 Black 48cm



MBW1U Fixed 300 Black 68cm



MBW1U Tilt 300 Black



MBW1U Tilt 300 Black 48cm



Model:	BW1U Fixed 300 Black	MBW1U Fixed 300 Black 48cm	MBW1U Fixed 300 Black 68cm	MBW1U Tilt 300 Black	MBW1U Tilt 300 Black 48cm
Screen size:	32"-50"	32"-50"	32"-55"	32"-55"	32"-50"
VESA:	Max 300x300mm	Max 400x300mm	Max 600x300mm	Max 300x300mm	Max 400x300mm
EAN:	735010521 9825	734023481 0826	734023481 0871	735007373 0247	734023481 0888
Max load:	50 kg	80 kg	80 kg	50 kg	80 kg
Bracket type:	Fixed	Fixed	Fixed	Tilt	Tilt
Landscape/portrait:	Yes	Yes	Yes	Yes	Yes
Wall distance:	5cm	5cm	5cm	5.6cm	5.6cm
Colour:	Black	Black	Black	Black	Black
Warranty:	5 years	5 years	5 years	5 years	5 years

MBW1U Tilt 300 Black 68cm



MBW2U Tilt 300 Black



MBW3U Tilt 300 Black



MBW4X1U Tilt VESA 300



MBW5X1U Tilt VESA 300



	MBW1U Tilt 300 Black	MBW2U Tilt 300 Black	MBW3U Tilt 300 Black	MBW4X1U Tilt VESA 300	MBW5X1U Tilt VESA 300
Model:	MBW1U Tilt 300 Black	MBW2U Tilt 300 Black	MBW3U Tilt 300 Black	MBW4X1U Tilt VESA 300	MBW5X1U Tilt VESA 300
Screen size:	32"-55"	32"-50"	32"-50"	32"-50"	32"-50"
VESA:	Max 600x300mm	Max 300x300mm	Max 300x300mm	Max 300x300mm	Max 300x300mm
EAN:	734023481 0895	735007373 0278	735007373 0285	735010521 6046	735007373 0308
Max load:	50 kg	30kg (Per screen)	30kg (Per screen)	30kg (Per screen)	30kg (Per screen)
Bracket type:	80 kg	Tilt	Tilt	Tilt	Tilt
Landscape/portrait:	Tilt	Landscape	Landscape	Landscape	Landscape
Wall distance:	Yes	5.6cm	5.6cm	5.6cm	5.6cm
Colour:	5.6cm	Black	Black	Black	Black
Warranty:	Black	5 years	5 years	5 years	5 years

MBSTH1UP 200x400 Fixed



MBW1U 400 Fixed



MBW1U 600 Fixed



MBW2U Fixed



MBW3U Fixed

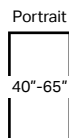

	Model: MBSTH1UP 200x400 Fixed	MBW1U 400 Fixed	MBW1U 600 Fixed	MBW2U Fixed	MBW3U Fixed
Screen size:	40" - 100"	40" - 65"	40" - 86"	40" - 65"	40" - 65"
VESA:	VESA 400, 40cm	VESA 400, 40cm	600x400 max	VESA 400, 40cm	VESA 400, 40cm
EAN:	735007373 8007	735010521 4059	735007373 3996	735007373 4009	735007373 4016
Max load:	45kg	30kg (Per screen)	30kg (Per screen)	30kg (Per screen)	30kg (Per screen)
Bracket type:	Fixed	Fixed	Fixed	Fixed	Fixed
Landscape / portrait:	Portrait	Yes	Yes	Yes	Yes
Wall distance:	5 cm	5 cm	5 cm	5 cm	5 cm
Colour (VESA arms):	Black	Black	Black	Black	Black
Colour (Horizontal rail):	Black (Silver optional)	Black (Silver optional)	Black (Silver optional)	Black (Silver optional)	Black (Silver optional)
Warranty:	5 years	5 years	5 years	5 years	5 years

MBW2U Tilt 200



MBW3U Tilt 200



MBW4U Tilt



MBW5U Tilt



M Wallmount Pro MBW4X1U 400 Stitching

Larger sizes available supporting up to 86"

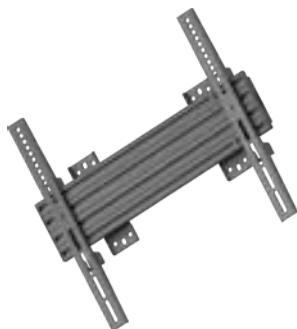

Model:	MBW4X1U 400 Stitching	MBW2U Tilt 200	MBW3U Tilt 200	MBW4U Tilt	MBW5U Tilt
Screen size:	32"-65"	27" - 42"	27" - 42"	40" - 65"	40" - 65"
VESA:	VESA 400 ,40cm	VESA 200, 20cm	VESA 200, 20cm	VESA 400, 40cm	VESA 400, 40cm
EAN:	735002273 9987	735007373 7031	735007373 7048	735010521 5995	735010521 6008
Max load:	30kg (Per screen)	30kg (Per screen)	30kg (Per screen)	30kg (Per screen)	30kg (Per screen)
Bracket type:	Fixed	Tilt (Fixed optional)	Tilt (Fixed optional)	Tilt (Fixed optional)	Tilt (Fixed optional)
Landscape / portrait:	Yes	Yes	Yes	Yes	Yes
Wall distance:	50mm	56 mm	56 mm	56 mm	56 mm
Colour (VESA arms):	Black	Black	Black	Black	Black
Colour (Horizontal rail):	Black / Silver	Black / Silver	Black / Silver	Black (Silver optional)	Black (Silver optional)
Warranty:	5 years	5 years	5 years	5 years	5 years



Wallmounts

For very large displays!

The Pro Series wall mounts are designed for menu boards and digital signage installations, offering precise display positioning and flexible adjustment options. A single horizontal extrusion

with optional push-in/pop-out and depth adjustment ensures fast alignment, even on irregular wall surfaces. It also provides convenient access behind the displays for easy servicing.

VESA 900 / 1000 / 1200 / 1600



Model:	M Wallmount Pro MBW1U 1600 Tilt Black
Screen size:	77" - 110"
VESA:	VESA 1600x600mm
EAN:	735010521 3298
Max load:	80kg
Bracket type:	Tilt (Fixed optional)
Landscape / portrait:	Landscape
Wall distance:	5.6 cm
Colour (VESA arms):	Black
Colour (Horizontal rail):	Black (Silver optional)
Warranty:	5 years
Accessories:	Cover plates

MBW1U 800 Fixed

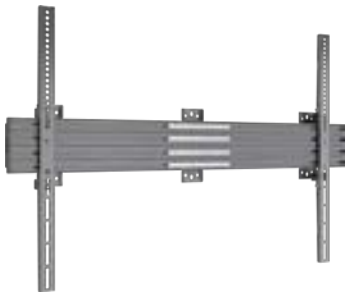

MBW1U 900 Fixed

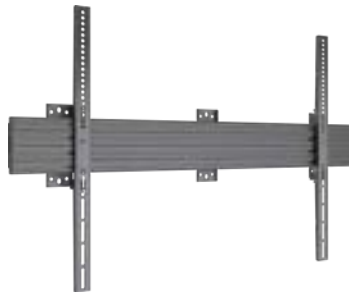

MBW1U 1000 Fixed

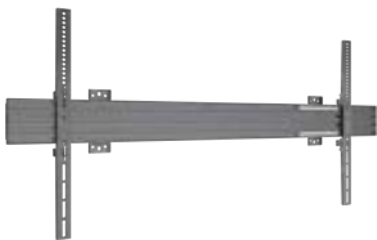

MBW1U 1000 Tilt



VESA 1000

Model:	MBW1U 800 Fixed	MBW1U 900 Fixed	MBW1U 1000 Fixed	MBW1U 1000 Tilt
Screen size:	55"-86"	65"-100"	65" - 120"	65" - 120"
VESA:	Max 900x600mm	Max 900x600mm	VESA 600, 60cm	VESA 600, 60cm
EAN:	735010521 9863	735010521 9146	735010521 4967	735010521 4950
Max load:	100 kg	100 kg	70kg	70kg
Bracket type:	Fixed	Fixed	Fixed	Tilt
Landscape / portrait:	Landscape	Landscape	Landscape	Landscape
Wall distance:	5cm	5cm	40 cm	5.6 cm
Colour (VESA arms):	Black	Black	Black	Black
Colour (Horizontal rail):	Black (Silver optional)	Black (Silver optional)	Black (Silver optional)	Black (Silver optional)
Warranty:	5 years	5 years	5 years	5 years

MBW1U 1000 Micro Adjustable



Wallmount Pro LG 110UM5 Tilt



MBW1U 1200 Fixed

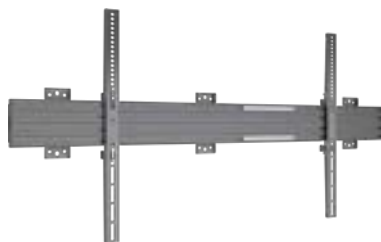

MBW1U 1600 Fixed



	MBW1U 1000 Micro Adjustable	Wallmount Pro LG 110UM5 Tilt	MBW1U 1000 Fixed	MBW1U 1600 Fixed
Model:	MBW1U 1000 Micro Adjustable	Wallmount Pro LG 110UM5 Tilt	MBW1U 1000 Fixed	MBW1U 1600 Fixed
Screen size:	65" - 120"	77" - 110"	75"-110"	85"-140"
VESA:	VESA 1000x600mm	VESA 1600x600mm	Max 600x1000mm	Max 1600x600mm
EAN:	735010521 4943	735010521 3298	735010521 9153	735010521 9870
Max load:	70kg	80kg	100 kg	150 kg
Bracket type:	Micro-Adjustable	Tilt (Fixed optional)	Fixed	Fixed
Landscape / portrait:	Landscape	Landscape	Landscape	Landscape
Wall distance:	5.8 cm to 8.8 cm	5.6 cm	5cm	5cm
Colour (VESA arms):	Black	Black	Black	Black
Colour (Horizontal rail):	Black (Silver optional)	Black (Silver optional)	Black (Silver optional)	5 years
Warranty:	5 years	5 years	5 years	5 years

MBW1UP 200x900 Fixed



MBW1UP 400x900 Fixed



MBW1UP 600x900 Fixed



MBW1UP 400x1200 Fixed Black

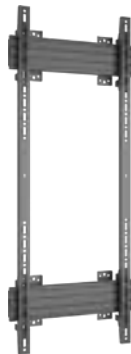

Portrait XL

MBW1UP 400x1600 Fixed Black



Portrait XL

Model:	MBW1UP 200x900 Fixed	MBW1UP 400x900 Fixed	MBW1UP 600x900 Fixed	MBW1UP 400x1200 Fixed Black	MBW1UP 400x1600 Fixed Black
Screen size:	40"-100"	40"-100"	40"-100"	75"-140"	75"-140"
VESA:	Max 200x900mm	VESA 400x900	Max 600x900mm	Max 400x1200mm	Max 400x1600mm
EAN:	735010521 9856	735007373 6942	735007373 8342	735010521 9412	735010521 9429
Max load:	40 kg	90kg	90 kg	125 kg	125 kg
Bracket type:	Fixed	Fixed	Fixed	Fixed	Fixed
Landscape / portrait:	Portrait	Yes	Portrait	Portrait	Portrait
Wall distance:	5cm	5 cm	5cm	6.7cm	6.7cm
Colour (VESA arms):	Black	Black	Black	Black	Black
Colour (Horizontal rail):	Black (Silver optional)	Black (Silver optional)	Black (Silver optional)	Black (Silver optional)	Black (Silver optional)
Warranty:	5 years	5 years	5 years	5 years	5 years

MBW1UP 600x1200 Fixed



Portrait XL

MBW1UP 600x1600 Fixed



Portrait XL

MBW1UP 800x1600 Fixed



Portrait XL



Samsung 115" UHD Signage QHFX

	Model: MBW1UP 600x1200 Fixed	MBW1UP 600x1600 Fixed	MBW1UP 800x1600 Fixed
Screen size:	75"-110"	75"-140"	75"-140"
VESA:	Max 600x1200mm	Max 600x1600mm	Max 800x1600mm
EAN:	735010521 9122	735010521 9436	735010521 9139
Max load:	125 kg	125 kg	125 kg
Bracket type:	Fixed	Fixed	Fixed
Landscape/portrait:	Yes	Portrait	Portrait
Wall distance:	6.7cm	6.7cm	6.7cm
Colour:	Black	Black	Black
Warranty:	5 years	5 years	5 years

Micro Adjustable Wall Mounts

The M Wallmount Pro Micro Adjustable Black features built-in fine-tune adjustments, allowing each screen to be individually aligned with its neighboring displays.

Easy-to-reach adjustment knobs make it possible to precisely align depth, side, and height, tasks that once took hours can now be completed in minutes. Truly an installer's dream.

Designed with Scandinavian heritage in mind, every part and detail serves both purpose and aesthetics. The result is a sleek, Nordic solution that emphasizes quality, function, and a clean professional look.

Crafted from premium materials, this versatile ceiling mount is suitable for a wide range of environments, delivering both durability and style.

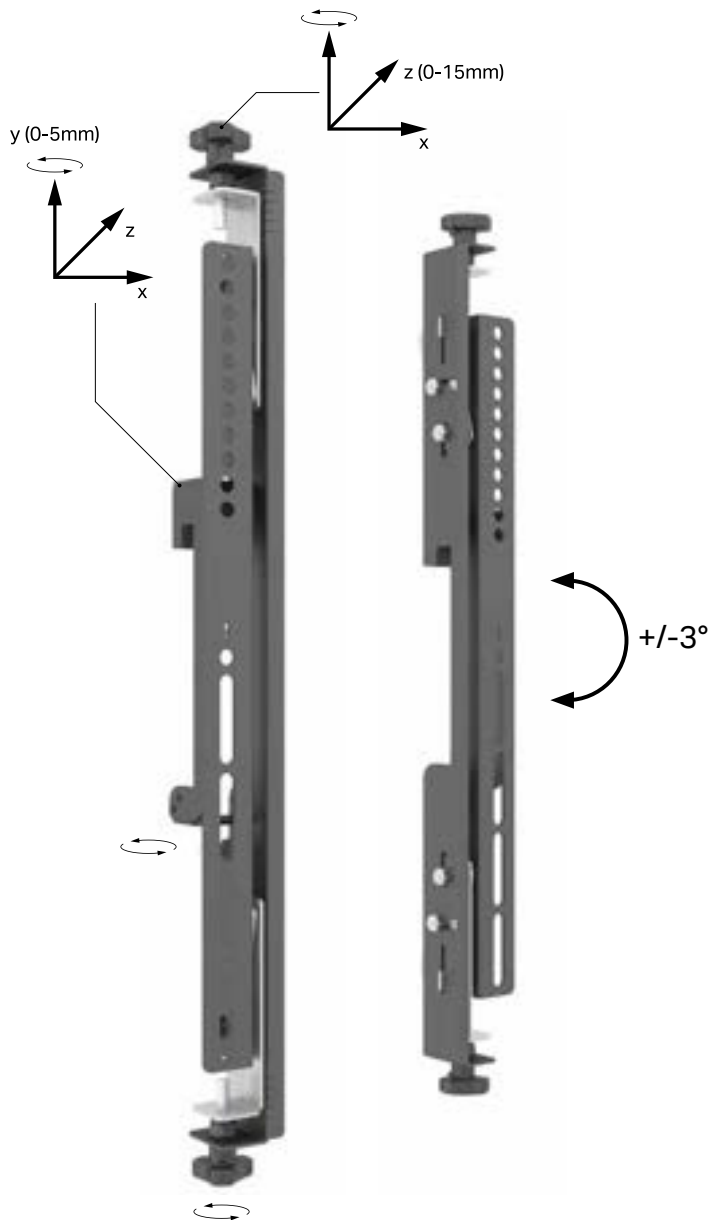

Easy Access for After Adjustments

Our micro-adjustable wall mounts provide quick and safe access to displays, ensuring precise handling down to the millimeter. This feature is essential when building video

walls or integrating single screens into wall structures, where easy servicing is a key requirement.

Portrait installations
VESA extender kits
EAN: 7350073734733

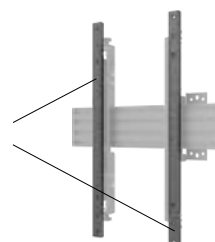

MBW1U 400 (Micro Adjustable)



MBW2U (Micro Adjustable)



MBW2U (Micro Adjustable)

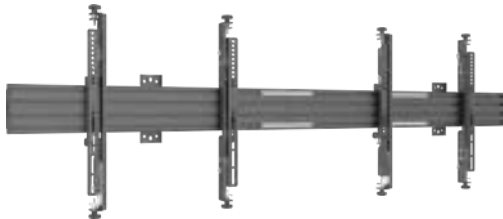

MBW3U (Micro Adjustable)

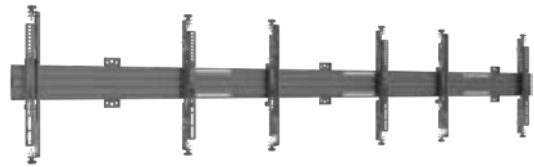

Model:	MBW1U 400 (Micro Adjustable)	MBW1U (Micro Adjustable)	MBW2U (Micro Adjustable)	MBW3U (Micro Adjustable)
Screen size:	43" - 65"	43" - 65"	43" - 65"	43" - 65"
VESA:	VESA 400, 40cm	VESA 400, 40cm	VESA 400, 40cm	VESA 400, 40cm
EAN:	735010521 4080	735010521 0624	735010521 0631	735010521 0648
Max load:	45 kg	45 kg	30 kg (per screen)	30 kg (per screen)
Bracket type:	Micro Adjustable	Micro Adjustable	Micro Adjustable	Micro Adjustable
Landscape / portrait:	Yes	Yes	Yes	Yes
Wall distance:	58mm to 73mm	58mm to 73mm	58mm to 73mm	58mm to 73mm
Colour (VESA arms):	Black (Silver optional)	Black (Silver optional)	Black (Silver optional)	Black (Silver optional)
Colour (Horizontal rail):	Black (Silver optional)	Black (Silver optional)	Black (Silver optional)	Black (Silver optional)
Warranty:	5 years	5 years	5 years	5 years

MBW4UP Micro Adjustable

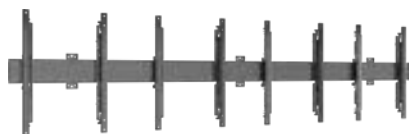

MBW4U Micro Adjustable



MBW5U Micro Adjustable

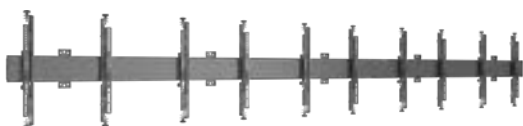

MBW4U Micro Adjustable

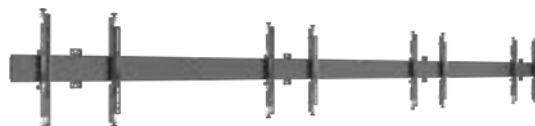

MBW4UP Micro Adjustable

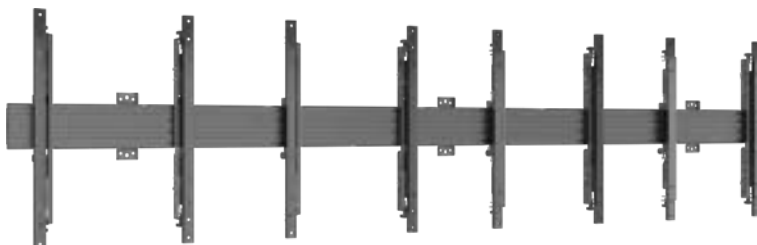

	MBW4U Micro Adjustable	MBW4UP Micro Adjustable	MBW5U Micro Adjustable	MBW4U Micro Adjustable	MBW4UP Micro Adjustable
Model:	MBW4U Micro Adjustable	MBW4UP Micro Adjustable	MBW5U Micro Adjustable	MBW4U Micro Adjustable	MBW4UP Micro Adjustable
Screen size:	32" - 65"	32" - 65"	43"-65"	43"-65"	43"-65"
VESA:	VESA 400,40cm	VESA 600,60cm	Max 600x400mm	VESA 400, 40cm	VESA 600, 60cm
EAN:	735007373 0179	735007373 0186	7 350 105 219 504	7 350 073 730 179	7 350 073 730 186
Max load:	30kg (Per screen)	30kg (Per screen)	30kg (Per screen)	30kg (Per screen)	30kg (Per screen)
Bracket type:	Micro adjustable	Micro adjustable	Micro-Adjustable Arms	Micro Adjustable	Micro Adjustable
Landscape / portrait:	Landscape	Portrait	Landscape	Landscape	Portrait
Wall distance:	5.8cm to 7.3cm	7.3cm to 8.8cm	5.8cm to 7.3cm	5.8cm to 7.3cm	7.3cm to 8.8cm
Colour:	Black	Black	Black	Black	Black
Warranty:	5 years	5 years	5 years	5 years	5 years



Pro Series

Large Dual Wall-Mounted Solutions

65" / 75" / 86" / 98" / 100"

MBW2UHD Fixed Black



MBW2UHD Tilt Black



MBW2UHD Micro Adjustable Black



MBW3U Micro Adjustable Black

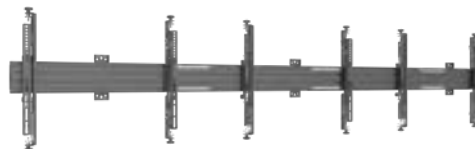

	MBW2UHD Fixed Black	MBW2UHD Tilt Black	MBW2UHD Micro Adjustable Black	MBW3U Micro Adjustable Black
Model:	MBW2UHD Fixed Black	MBW2UHD Tilt Black	MBW2UHD Micro Adjustable Black	MBW3U Micro Adjustable Black
Screen size:	75"	75"	75"	43" - 65"
VESA:	VESA 200, 20cm	VESA 300, 30cm	VESA 300, 30cm	VESA 400, 40cm
EAN:	735010521 5759	735010521 5766	735010521	735010521 0648
Max load:	70kg (Per screen)	70kg (Per screen)	40kg (Per screen)	30kg (Per screen)
Bracket type:	Fixed (Tilt optional)	Tilt (Fixed optional)	Micro-Adjustable Arms	Micro-Adjustable Arms
Landscape / portrait:	Yes	Yes	Yes	Yes
Wall distance:	5.6cm	5.6cm	5.8cm to 7.3cm	5.8 cm to 7.3 cm
Colour (VESA arms):	Black	Black	Black	Black
Colour (Horizontal rail):	Black (Silver optional)	Black (Silver optional)	Black (Silver optional)	Black (Silver optional)
Warranty:	5 years	5 years	5 years	5 years





Add Media Storage to Pro Series Wall Mounts

The Multibrackets Pro Series offers a smart solution for integrating storage directly behind the display. The M Pro Series Media Storage Panel is a slide-out tray that allows AV equipment to be mounted discreetly while remaining easily accessible.

With this solution, service and adjustments can be carried out without removing the display - saving time while keeping installations clean and professional.



Model:	Media Storage Slide Panel
Material:	Steel
EAN:	735010521 3847
Type:	Part for M Pro Series
Surface Finish:	Powder coating
Weight:	3,5 kg
Colour:	Black & silver
Warranty:	5 years

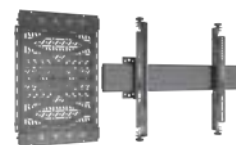

Model:	MBW1U Media Storage
Screen size:	65" - 120"
VESA:	VESA 400, 40cm
EAN:	735010521 4332
Max load:	45 kg
Bracket type:	Micro Adjustable
Landscape / portrait:	Landscape
Wall distance:	58mm to 73mm
Colour (VESA arms):	Black
Colour (Horizontal rail):	Black (Silver optional)
Warranty:	5 years

MBW2U Media Storage



MBW3U Media Storage



MBW1U 800 Push in Push out Media Storage

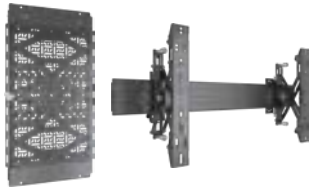

MBW2U 800 Push in Push out Media Storage

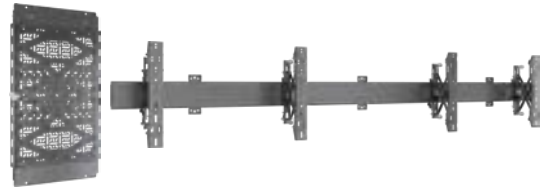

MBW3U 800 Push in Push out Media Storage

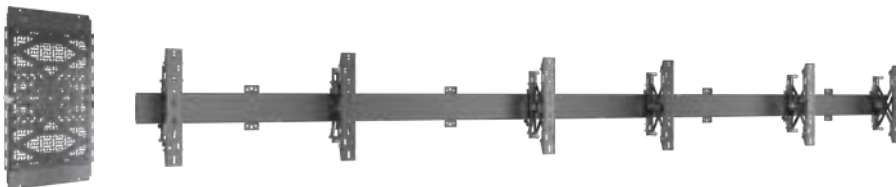

Model:	MBW2U Media Storage	MBW3U Media Storage	M Wallmount Pro MBW1U 800 Push in Push out	M Wallmount Pro MBW2U 800 Push in Push out	M Wallmount Pro MBW3U 800 Push in Push out
Screen size:	46" - 65"	43" - 65"	55" - 75"	65" - 75"	75"
VESA:	VESA 400, 40cm	VESA 400, 40cm	Max 800x400mm	Max 800x400mm	Max 800x400mm
EAN:	735010521 4349	735010521 4356	735002273 7105	735002273 7143	735002273 7242
Max load:	30kg (Per screen)	30 kg (per screen)	40 kg	40 kg	40 kg
Bracket type:	Micro Adjustable	Micro Adjustable	Push in pop out	Push in pop out	Push in pop out
Landscape / portrait:	Landscape	Landscape	Landscape	Landscape	Landscape
Wall distance:	58mm to 73mm	58mm to 73mm	9.5cm to 23.7cm	9.5cm to 23.7cm	9.5cm to 23.7cm
Colour (VESA arms):	Black	Black	Black	Black	Black
Colour (Horizontal rail):	Black (Silver optional)	Black (Silver optional)	Black (Silver optional)	Black (Silver optional)	Black (Silver optional)
Warranty:	5 years	5 years	5 years	5 years	5 years



Push in pop out

Wallmounts / videowalls

The Push-In / Pop-Out feature is a mechanism built into certain display wall mounts that allows quick access to the front of the mounted screen without needing to fully uninstall or detach it. Essentially, it provides a simple push-to-release (pop-out), then push-back (push-

in) operation. This makes maintenance, cable access, or display changes far easier and faster.





Retracted

Extended

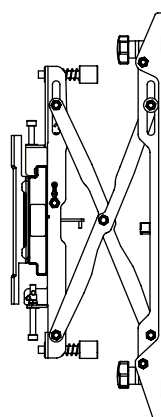
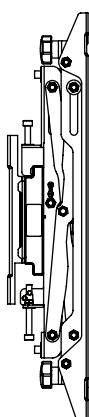

MBW1U 48cm

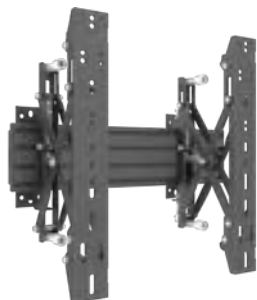

MBW1U 68cm

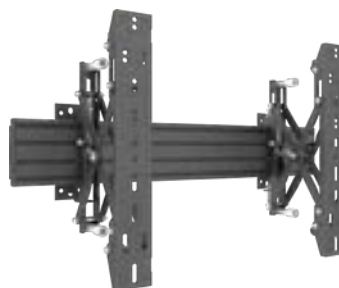

M Wallmount Pro MBW1U 800 Push in Push out

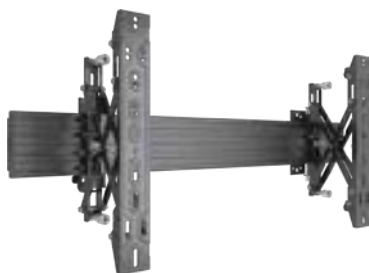

MBW2U

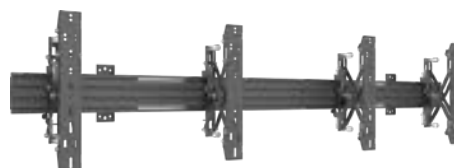

	MBW1U 48cm (Black)	MBW1U 68cm (Black)	MBW1U 800 Push in Push out	MBW2U (Black)
Model:	MBW1U 48cm (Black)	MBW1U 68cm (Black)	MBW1U 800 Push in Push out	MBW2U (Black)
Screen size:	40" - 65"	40" - 65"	55"-75"	40" - 65"
VESA:	VESA 400, 40cm	VESA 400, 40cm	Max 800x400mm	VESA 400, 40cm
EAN:	735007373 5105	735007373 4115	735002273 7075	735007373 4122
Max load:	35 kg	35 kg	40 kg	30 kg (Per screen)
Bracket type:	Push in pop out	Push in pop out	Push in pop out	Push in pop out
Landscape / portrait:	Yes	Yes	Landscape	Yes
Wall distance:	9,5 cm to 23,7 cm	9,5 cm to 23,7 cm	9.5cm to 23.7cm	9,5 cm to 23,7 cm
Colour (VESA arms):	Black	Black	Black	Black
Colour (Horizontal rail):	Black (Silver optional)	Black (Silver optional)	Black (Silver optional)	Black (Silver optional)
Warranty:	5 years	5 years	5 years	5 years

M Wallmount Pro MBW2U 800 Push in Push out



MBW3U

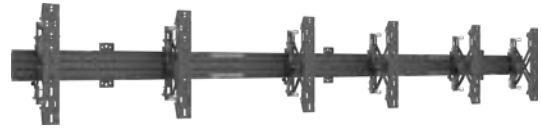

M Wallmount Pro MBW3U 800 Push in Push out



M Wallmount Pro MBW5X1U Push In Pop Out



	MBW2U 800 Push in Push out	MBW3U (Black)	MBW3U 800 Push in Push out	MBW5X1U Push In Pop Out
Model:	MBW2U 800 Push in Push out	MBW3U (Black)	MBW3U 800 Push in Push out	MBW5X1U Push In Pop Out
Screen size:	65"-75"	40" - 65"	75"	37"-65"
VESA:	Max 800x400mm	VESA 400, 40cm	Max 800x400mm	Max 600x400mm
EAN:	735002273 7082	735007373 4139	735002273 7099	735010521 9498
Max load:	40 kg	30 kg (Per screen)	40 kg	30kg (Per screen)
Bracket type:	Push in pop out	Push in pop out	Push in pop out	Push in pop out
Landscape / portrait:	Landscape	Yes	Landscape	Landscape
Wall distance:	9.5cm to 23.7cm	9,5 cm to 23,7 cm	9.5cm to 23.7cm	9.6cm to 22.3cm
Colour (VESA arms):	Black	Black	Black	Black
Colour (Horizontal rail):	Black (Silver optional)	Black (Silver optional)	Black (Silver optional)	Black (Silver optional)
Warranty:	5 years	5 years	5 years	5 years

MBW2UX2



MBW2UX3



MBW3X2U

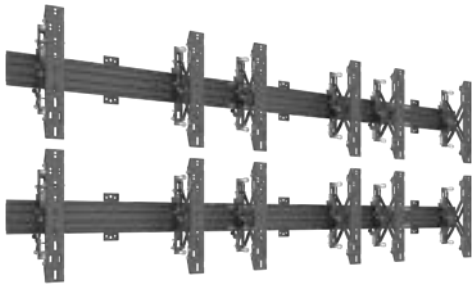

MBW3X3U

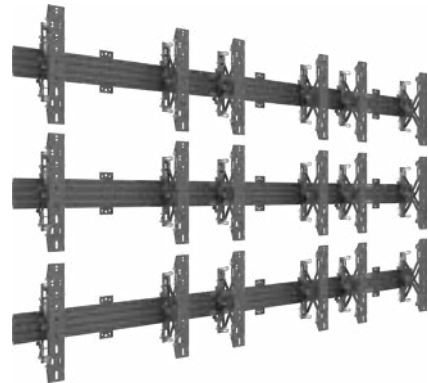

	MBW2UX2 Push In Pop Out	MBW2UX3 Push In Pop Out	MBW3X2U	MBW3X3U
Screen size:	40" - 65"	40" - 65"	40" - 65"	40" - 65"
VESA:	VESA 400, 40cm	VESA 400, 40cm	VESA 400, 40cm	VESA 400, 40cm
EAN:	735010521 2628	735010521 2635	735007373 5006	735007373 5013
Max load:	30 kg (Per screen)	30 kg (Per screen)	30 kg (Per screen)	30 kg (Per screen)
Bracket type:	Push in pop out	Push in pop out	Push in pop out	Push in pop out
Landscape / portrait:	Yes	Yes	Yes	Yes
Wall distance:	9,5 cm to 23,7 cm	9,5 cm to 23,7 cm	9,5 cm to 23,7 cm	9,5 cm to 23,7 cm
Colour (VESA arms):	Black	Black	Black	Black
Colour (Horizontal rail):	Black (Silver optional)	Black (Silver optional)	Black (Silver optional)	Black (Silver optional)
Warranty:	5 years	5 years	5 years	5 years

MBW2X1UP

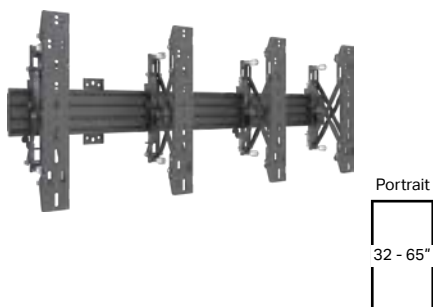

MBW3X1UP

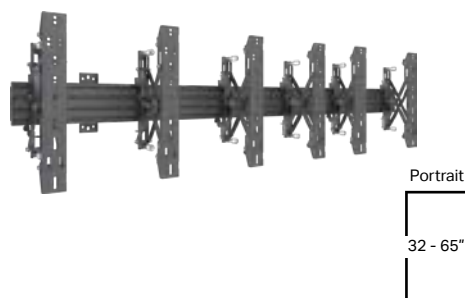

MBW3X2UP

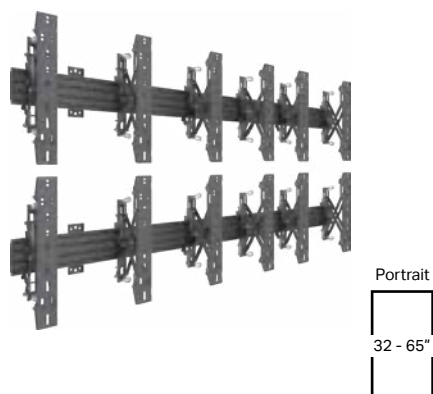

MBW3X3UP

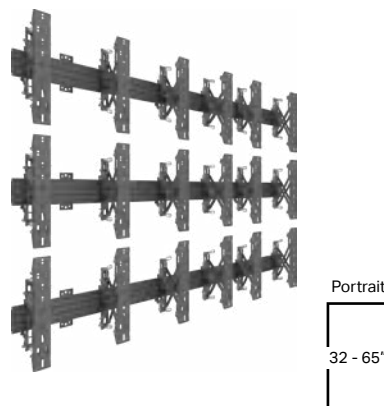

	MBW2X1UP	MBW3X1UP	MBW3X2UP	MBW3X3UP
Model:	MBW2X1UP	MBW3X1UP	MBW3X2UP	MBW3X3UP
Screen size:	40" - 65"	40" - 65"	40" - 65"	40" - 65"
VESA:	VESA 400, 40cm	VESA 400, 40cm	VESA 400, 40cm	VESA 400, 40cm
EAN:	735007373 5020	735007373 5037	735007373 5044	735007373 5051
Max load:	30 kg (Per screen)	30 kg (Per screen)	30 kg (Per screen)	30 kg (Per screen)
Bracket type:	Push in pop out	Push in pop out	Push in pop out	Push in pop out
Landscape / portrait:	Portrait	Portrait	Portrait	Portrait
Wall distance:	9,5 cm to 23,7 cm	9,5 cm to 23,7 cm	9,5 cm to 23,7 cm	9,5 cm to 23,7 cm
Colour (VESA arms):	Black	Black	Black	Black
Colour (Horizontal rail):	Black (Silver optional)	Black (Silver optional)	Black (Silver optional)	Black (Silver optional)
Warranty:	5 years	5 years	5 years	5 years

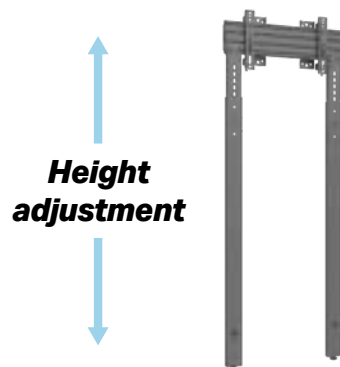

Wallmounts with Floor support

The Floor Support system is designed for situations where a wall alone cannot safely carry the weight of a digital signage display. By combining a wall mount with a vertical support column, the load is transferred directly to the floor, ensuring stability even on weak or hollow walls. The

height-adjustable design allows precise positioning, while integrated cable management keeps installations clean and professional. This solution makes it possible to mount heavy or large screens in places where standard wall mounts are not an option.

Model name:	Wallmount Fixed MBW1U 200 w Floorsupport
Screen size:	32"-50"
VESA:	VESA300, 30cm
EAN:	735010521 8408
Max load:	50 kg
Bracket type:	Fixed
Landscape/portrait:	Yes
Floor support:	5cm
Wall distance:	1025-1705mm
Colour (VESA arms):	Black
Colour (horizontal rail):	Black (Silver optional)
Warranty:	5 years

Wallmount Fixed MBW1U 400 w Floorsupport

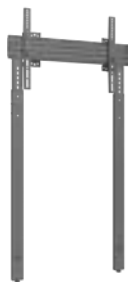

Wallmount Fixed MBW1U 600 w Floorsupport

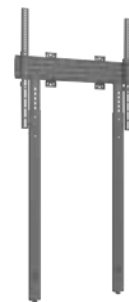

Wallmount Fixed MBW1U 900x600 w Floorsupport



Wallmount Fixed MBW1U 1200x900 w Floorsupport



Collaboration - Wallmount Fixed MBW1U 900x600 w Floorsupport



Collaboration - Wallmount Fixed MBW1U 1200x900 w Floorsupport



Collaboration Solutions

Model name:	Wallmount Fixed MBW1U 400 w Floorsupport	Wallmount Fixed MBW1U 600 w Floorsupport	Wallmount Fixed MBW1U 900x600 w Floorsupport	Wallmount Fixed MBW1U 1200x900 w Floorsupport	Collaboration - Wallmount Fixed MBW1U 900x600 w Floorsupport	Collaboration - Wallmount Fixed MBW1U 1200x900 w Floorsupport
Screen size:	50"-65"	55"-85"	65"-85"	65"-98"	65"-85"	65"-98"
VESA:	VESA400, 40cm	VESA600, 60cm	VESA900, 90cm	VESA900, 90cm	Max 900x600mm	Max 1200x900mm
EAN:	735010521 8392	735010521 8385	734023481 0802	734023481 0819	734023481 0833	734023481 0840
Max load:	50 kg	50 kg	50 kg	50 kg	50 kg	50 kg
Bracket type:	Fixed	Fixed	Fixed	Fixed	Fixed	Fixed
Landscape/portrait:	Yes	Landscape	Landscape	Landscape	Yes	Yes
Floor support:	5cm	5cm	5cm	5cm	5cm	5cm
Wall distance:	1025-1705mm	1025-1705mm	1025-1705mm	1025-1705mm	1025-1705mm	1025-1705mm
Colour (VESA arms):	Black	Black	Black	Black	Black	Black
Colour (horizontal rail):	Black	Black	Black	Black	Black	Black
Warranty:	5 years	5 years	5 years	5 years	5 years	5 years

Installers welcome

Adjustable Wall Plate Box



A Smart Wall Bracket with Built-In Storage Space

The Pro Series Wall Plate Box is a versatile solution that functions as both a standard VESA mount and a wall bracket. It also serves as an all-in-one display bracket, allowing you to mount both the system and the display directly onto the wall — combining simplicity, functionality, and built-in storage in a single sleek solution.

Add a Codec or Accessory Behind Your Display

The M Pro Series Adjustable Wall Plate Box provides an elegant way to integrate codecs, players, or accessories directly behind the screen. Designed for dual-screen installations from 40" to 75", it offers both functionality and a clean, professional appearance.

Supports Multiple VESA Standards

Compatible with a wide range of VESA patterns - including 100x100, 100x200, 200x100, 200x200, and 400x200. The mount ensures broad compatibility with today's most common display requirements.



Combining



Tilt: 0°/5°/10°



Kick stand: 23°

Model:	M Pro Series Adjustable Wall Plate Box
Screen size:	32" - 75"
VESA:	Adjustable from 100x100 to 400x400 max
EAN:	735010521 7821
Max load:	75 kg
Weight:	5 kg
Measurements:	52.4 x 26.3 x 8.7 cm
Tilt:	0° / 5° / 10°
Colour:	Black
Material:	Steel
Warranty:	5 years

M Wallmount Pro MBW1U Fixed Black – Wallbox



M Wallmount Pro MBW1U Tilt Black – Wallbox



MBW1U Push in Pop out – Wallbox

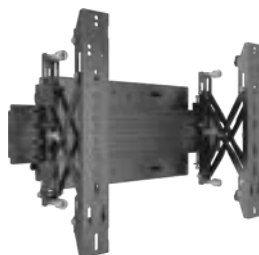

MBW1U 400x600 Fixed



MBW1U 400x900 Fixed



Model:	MBW1U Fixed – Wallbox	MBW1U Tilt – Wallbox	MBW1U Push in Pop out – Wallbox	MBW1U 400x600 Fixed	MBW1U 400x900 Fixed
Screen size:	40"-75"	40"-75"	40"-75"	40"-75"	55"-85"
VESA:	VESA400, 40cm	VESA400, 40cm	VESA400, 40cm	600x400 max	900x400 max
EAN:	735002273 3510	735002273 3527	735002273 3534	734023481 0734	734023481 0741
Max load:	70 kg	70 kg	35 kg	70 kg	70 kg
Bracket type:	Fixed	Tilt	Push in pop out	Fixed	Fixed
Landscape / portrait:	Yes	Yes	Landscape	Portrait	Portrait
Wall distance:	10.7 cm	11.3 cm	27.7 cm	10.7 cm	10.7 cm
Colour (VESA arms):	Black	Black	Black	Black	Black
Colour (Horizontal rail):	Black	Black	Black	Black	Black
Warranty:	5 years	5 years	5 years	5 years	5 years



No measuring. No guessing. No errors.

Public Video Wall Mounts

Video walls should be simple to configure, fast to install, and easy to maintain. The Multibrackets range of full-service video wall mounts makes this possible.

Custom wall plate spacers take care of the precise measurements, so all you need to do is install the first mount - then use the spacers to perfectly position each additional mount. The result is a flawless video wall setup with minimal effort.

Video Wall Mount Push X Small



Video Wall Mount Push X Small 200



Video Wall Mount Push Slim



Super slim

Video Wall Mount Push HD

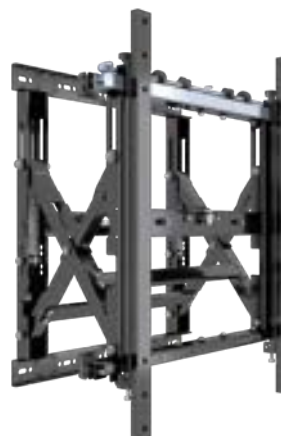

Model name:	Video Wall Mount Push X Small	Video Wall Mount Push X Small 200	Video Wall Mount Push Slim	Video Wall Mount Push HD
Screen size:	13" - 32"	13" - 43"	40" - 55"	43" - 70"
VESA:	50x50, 75x75, 100x100	50x50, 75x75, 100x100, 200x200	VESA 600x400/400x600	200x200, 300x200, 300x300, 400x200, 400x400, 400x600, 600x400
EAN:	735010521 0952	735010521 5636	735007373 9967	735007373 0568
Colour:	Black	Black	Black	Black
Size in mm:	251 x 298 x 74 mm	251 x 298 x 74 mm	534 x 542 mm	760 x 460mm
Max load:	18 kg	18 kg	35kg	50 kg
Weight:	2.6 kg	3.5 kg	7.5 kg	12 kg
Warranty:	2 years	2 years	2 years	2 years



Public Video Wall Mount Push HD

The M Public Video Wall Mount Push HD is one of the market's most innovative and installer-friendly video wall mounts. Featuring a tailored pantograph alignment system and numerous post-installation

adjustment options, it combines simplicity with power, making it one of the easiest yet most advanced video wall mounting solutions available today.

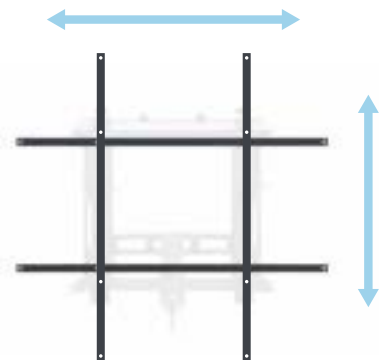

**Powerful VESA Extenderkits available
From 600mm to 1200mm**

M Public Video Wall Mount Push HD



M Public Video Wall Mount Push Slim



M Public Video Wall Mount Glide HD



Adjustment:
Numerous post installation possibilities

M Public Video Wall Mount Push HD Max 90kg

(with extenders)



Up to VESA 900

M Public Video Wall Mount Push SD 150Kg Max



M Public Video Wall Mount Push HD Max 90kg

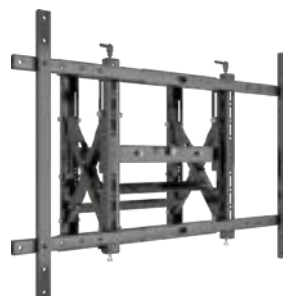

Model name:	M Public Video Wall Mount Push HD	M Public Video Wall Mount Push Slim	M Public Video Wall Mount Glide HD	Video Wall Mount Push HD Max 90kg	M Public Video Wall Mount Push SD 150Kg Max	M Public Video Wall Mount Push Wide HD Max 90kg
Screen size:	40" - 75"	40" - 75"	40" - 70"	50" - 95"	50" - 110"	46" - 120"
EAN:	735007373 0568	735007373 9967	735007373 5792	735007373 1749	735007373 4818	735007373 0506
VESA:	200x200, 300x200, 300x300, 400x200, 400x400, 400x600, 600x400	200x200, 300x200, 300x300, 400x200, 400x400, 400x600, 600x400	200x200, 300x200, 300x300, 400x200, 400x400	200x200, 300x300, 400x200, 400x400, 600x400, 400x600, 800x400, 400x800, 900x400, 400x900	200x200, 300x200, 300x300, 400x200, 400x400	300x600, 400x600, 500x600, 600x600, 700x600, 800x600, 900x600mm
By adapterkit:	600x400 and 800x400	600x400 and 800x400	600x400 and 800x400	Up to 900x600	Up to 900x600	Up to 900x600
Size in mm:	760 x 460mm	534 x 542 mm	760 x 460mm	760 x 460mm	760x460mm	760x460mm
Max load:	50 kg	35 kg	35 kg	90 kg	150 kg	90 kg
Weight:	12 kg	7.5 kg	12 kg	14 kg	14 kg	17 kg
Warranty:	2 years	2 years	2 years	2 years	2 years	2 years

Public video wall

Mount Push HD 1200/1600 XL

The M Public Video Wall Mount Push HD 1200 XL supports VESA patterns from 300x600 to 1200x600 mm and loads up to 135 kg. This heavy-duty dual-rail pop-out mount suits 85"-120" displays from major brands like Samsung, LG, Philips, Sony, and NEC, ideal for recessed installs and easy maintenance.

Its smooth, soft-opening pop-out mechanism provides safe rear access, while tool-less micro-adjustments (± 10 mm in depth, height, and lateral) ensure perfect alignment. Integrated cable management keeps installations clean and professional.

Supporting both landscape and portrait modes, it fits a wide range of signage and interactive display applications. Installation is simplified with keyhole fixings and a hook-on design, with optional safety screws for added security.



**Landscape
and portrait**



Min 126mm



Max 310mm

Flexible after service!

- Reach any cables
- Reach any details

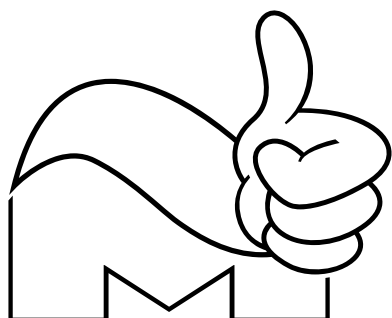
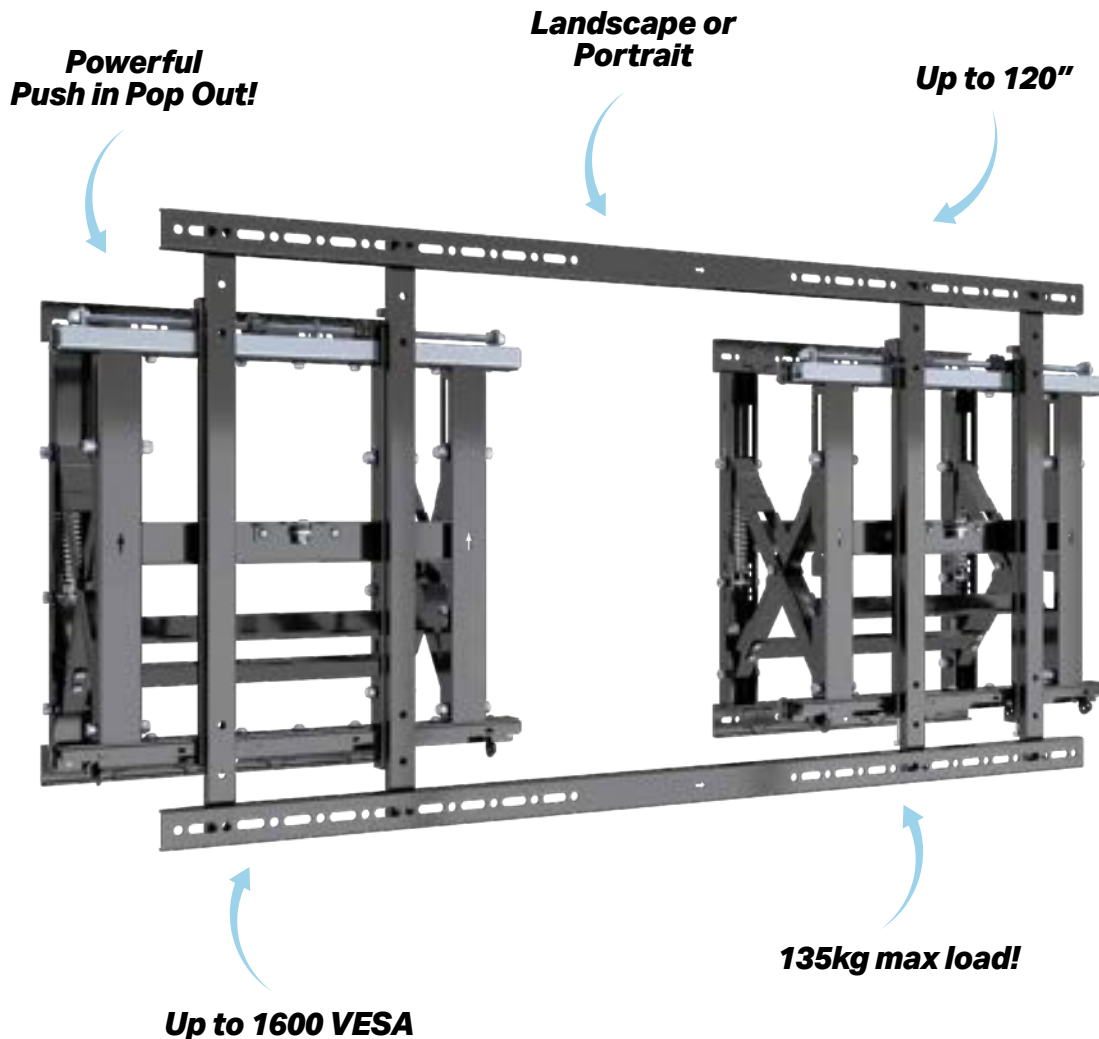

Model:	M Public Video	M Public Video
Screen size:	Wall Mount Push HD 1200 XL	Wall Mount Push HD 1600 XL
VESA:	85"-120"	85"-160"
EAN:	735002273 9086	735002273 9093
VESA:	300x600, 400x600, 500x600, 600x600, 700x600, 800x600, 900x600, 1000x600, 1100x600, 1200x600mm	300x600, 400x600, 500x600, 600x600, 700x600, 800x600, 900x600, 1000x600, 1100x600, 1200x600, 1400x600, 1600x600mm
Max load:	135 kg	135 kg
Pillar length:	Yes	Yes
Warranty:	2 years	2 years



Column & Column Dual

M Wallmount

An innovative solution for mounting single or dual displays directly onto columns, without the need for drilling. Designed specifically for indoor use, this system makes it easy and safe to mount digital signage displays on round columns, with support for both landscape and portrait orientation.

Perfect for stadiums, arenas, retail stores, and any environment where column-based mounting is preferred, it provides a secure and flexible way to attach displays to columns of various diameters.

Powerful flat band

Works with squared and round columns

Adjustable in size

Min. diameter: 23cm
Max. diameter: 73cm



Round column



Square column

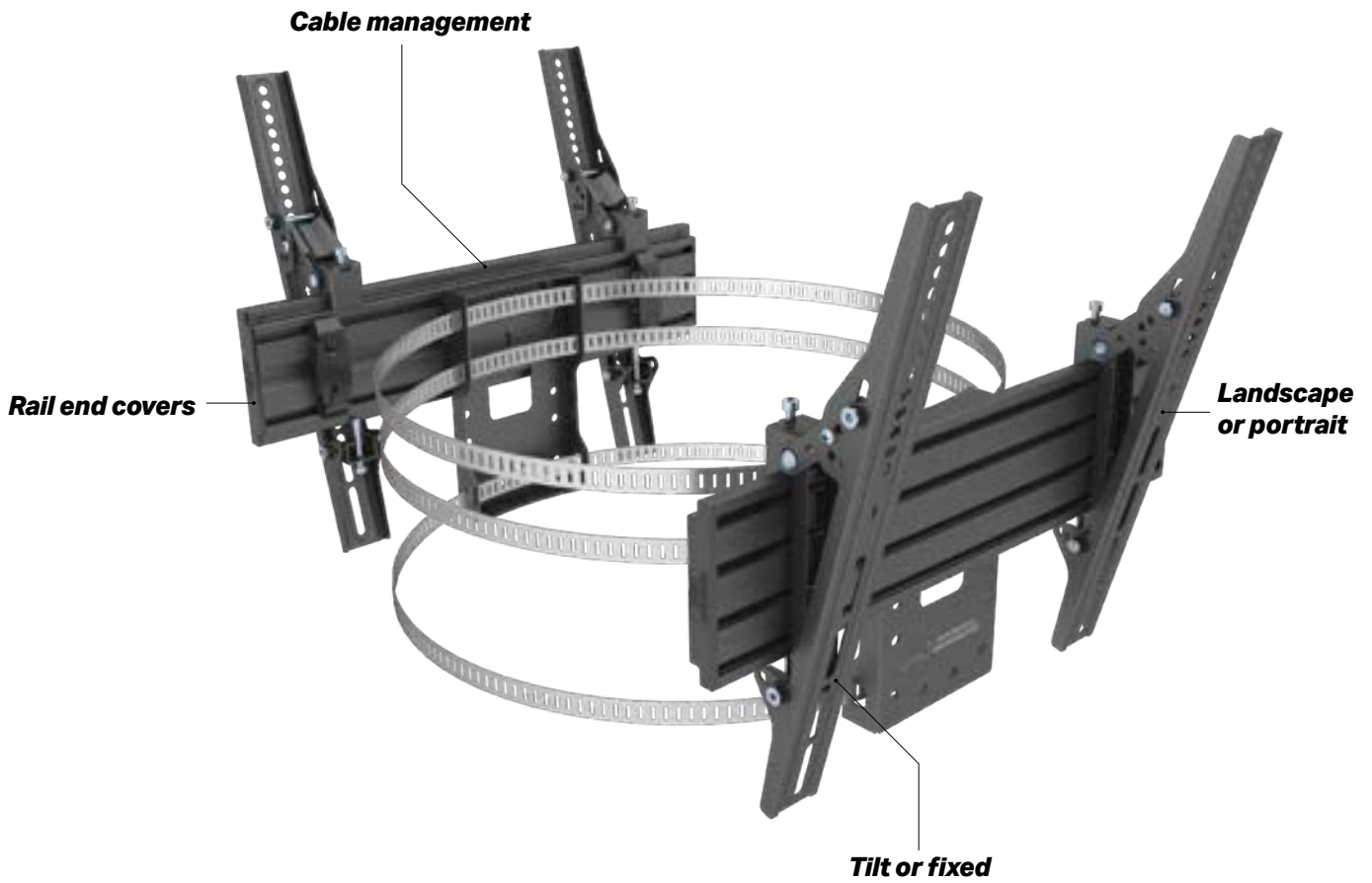

	M Wallmount Column	M Wallmount Column Dual	Wallmount Column HD	M Wallmount Column Dual HD
Model:	M Wallmount Column	M Wallmount Column Dual	Wallmount Column HD	M Wallmount Column Dual HD
EAN:	735007373 8458	735010521 3076	735002273 9475	735002273 9031
Screen size:	32" - 65"	32" - 65"	32" - 65"	32" - 65"
Type:	Single Side MBW1U	Double Side MBW1U	Single Side MBW1U	Double Side MBW1U
VESA standard:	VESA 400, 40cm	VESA 400, 40cm	VESA 600, 60cm	VESA 600, 60cm
Material:	Steel, Aluminium	Steel, Aluminium	Steel, Aluminium	Steel, Aluminium
Max Load:	35 kg	35 kg (Per screen)	35 kg	35 kg (Per screen)
Tilt:	Yes, -6~15°	Yes, -6~15°	Yes, -6~15°	Yes, -6~15°
Warranty:	5 years	5 years	5 years	5 years

Outdoor Wallmounts



Samsung

M Pro Series for Samsung OH46/55/75 displays



	OH46F/B	OH55F/B/A-S	OH075	OH46 B-S/DX with Frame	OH55 A-S/DX with Frame	OH75F-A with Frame
Screen size:	46"	55"	75"	46"	55"	75"
VESA:	995x500	1186x560	Customized for OH75F	Customized for B-S/DX	Customized for A-S/DX	1118x870
EAN:	735010521 4745	735010521 4752	735010521 5339	735010521 8125	735010521 8132	735010521 8149
Size in cm:	125 x 65 x 9	106 x 59 x 9	200 x 100 x 20	125 x 65 x 9	106 x 59 x 9	178,2 x 106
Weight:	10.5 kg	12.5 kg	16 kg	12.5 kg	10.5 kg	29 kg
Colour:	Black	Black	Black	Black	Black	Black
Warranty:	5 years	5 years	5 years	5 years	5 years	5 years



Made in EU

Hergestellt nach europäischen Qualitätsstandards



LG

M Pro Series for LG IP49 and IP55 displays



	LG IP 49 Outdoor	49" With frame	LG IP 55 Outdoor	55XE4F-M with Frame	LG 75XF3C-B/ 75XE3C
Screen size:	49"	49"	55"	55"	75"
VESA:	995x500	995x500	1186x560	1186x560	LG 75XF3C-B & 75XE3C
EAN:	7350010521 7838	734023481 2943	7350010521 7845	735010521 9184	735010521 8675
Size in cm:	125 x 65 x 9	125 x 65 x 9	106 x 59 x 9	106 x 59 x 9	205 x 108
Weight:	10.5 kg	10.5 kg	12.5 kg	15 kg	20 kg
Colour:	Black	Black	Black	Black	Black
Warranty:	5 years	5 years	5 years	5 years	5 years



Smart Signage Outdoor Totems

Samsung OHF Series 46"/55"/75"

LG XE4F Series 49"/55"/75"

A powerful all-in-one signage solution for outdoor business communication.

Boost drive-thru sales and improve order efficiency with Multibrackets' universal Outdoor Digital Menu Boards, designed to support Samsung's 46", 55", 75", and 85" outdoor displays. These all-weather-rated units feature low operating costs, a modular design, and straightforward installation. When paired with Samsung OHF Series SMART Signage,

they deliver a complete outdoor engagement solution built for durability, flexibility, and 24/7 performance — even in extreme conditions.

Switching to digital with Multibrackets Outdoor Totems and LG's XE4F Series eliminates the need to manually update static menus. Instead, content can be updated remotely and

in real time, creating a seamless drive-thru experience for customers while increasing restaurant efficiency. With their slim, robust design, LG XE4F displays integrate perfectly into Multibrackets outdoor totems, enabling simple installation and flexible customization to fit your partner's specific needs.

Highlights:

- **Made in Europe**
- **Slim depth**
- **Easy access**
- **Tailormade height possible**
- **Top level materials**
- **Easy installation**

Samsung outdoor totems

46" / 55" / 75"



	M Totem Pro Single OH55F/B/A-S	M Totem Pro Dual OH55F/B/A-S	M Totem Pro Triple OH55F/B/A-S
For screen size:	55"	55"	55"
VESA standard:	560x1186mm	560x1186mm	560x1186mm
EAN:	735002273 6580	735002273 6597	735002273 6603
Colour:	Black	Black	Black
Warranty:	5 years	5 years	5 years

Check our website for 46" / 75"

LG outdoor totems

49" / 55" / 75"



	M Totem Pro Single 55XE4F-M	M Totem Pro Dual 55XE4F-M	M Totem Pro Triple 55XE4F-M
For screen size:	55"	55"	55"
VESA standard:	LG proprietary fitting	LG proprietary fitting	1186x560
EAN:	735010521 6978	735010521 6985	735010521 6992
Colour:	Black	Black	Black
Warranty:	5 years	5 years	5 years

Check our website for 49" / 75"



Pro Series Collaboration Video Conference

Effective videoconferencing expands collaboration by enabling face-to-face meetings across distances, helping build trust, accelerate decision-making, and reduce travel costs. It allows teams to work from anywhere, connect with peers worldwide, and participate in online training with ease.

With Multibrackets Pro Series Collaboration solutions, video conferencing becomes simple and seamless - optimizing communication in meeting rooms, offices, and workplaces, so you can connect with people anytime, anywhere.

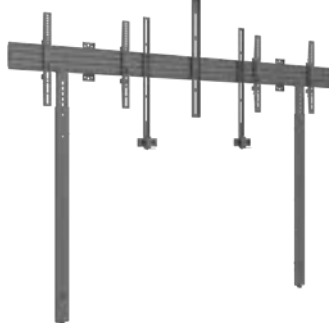
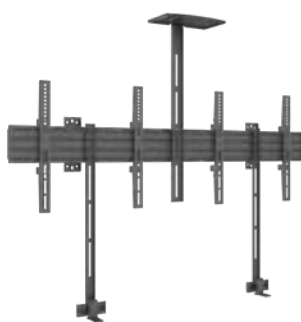

Max length 1705mm



Min length 1025mm

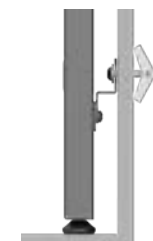

Gypsum Wall Expansion Nails

Can be used with or without supportive legs

MBW1USB 400 Fixed



MBW1USB 600 Fixed



MBW1USB 800 Fixed



MBW1USB 900 Fixed



	MBW1USB 400 Fixed	MBW1USB 600 Fixed	MBW1USB 800 Fixed	MBW1USB 900 Fixed
Model:	MBW1USB 400 Fixed	MBW1USB 600 Fixed	MBW1USB 800 Fixed	MBW1USB 900 Fixed
EAN:	734023481 2134	734023481 2141	734023481 2158	734023481 2165
Screen size:	40"-65"	40"-86" displays	55"-86"	65"-100"
VESA:	From 100x100 to 400x400	From 100x100 to 600x400	From 100x100 to 800x600	From 100x100 to 900x600
Material:	Steel, Aluminium	Steel, Aluminium	Steel, Aluminium	Steel, Aluminium
Color:	Black	Black	Black	Black
Surface Finish:	Powder coating/Anodic Oxidation	Powder coating/Anodic Oxidation	Powder coating/Anodic Oxidation	Powder coating/Anodic Oxidation
Weight:	4.7 kg	5,2 kg	10 kg	9,5 kg
Measurements:	66x16x15cm	86x16x15cm	100.5x16x15cm	104x16x15cm
Max Load:	70 kg per screen ((TÜV level is 30 kg per screen))	70 kg per screen ((TÜV level is 30 kg per screen))	100 kg	100 kg
Soundbarholder:	Yes	Yes	Yes	No
Cable Management:	Yes	Yes	Yes	No
Height Adjustment:	10 mm	10 mm	10 mm	-
Options:	M Pro Series Parts	M Pro Series Parts	M Pro Series Parts	M Pro Series Parts
Certifications:	CE	CE	CE	CE
Warranty:	5 years	5 years	5 years	5 years

Collaboration MBW1U

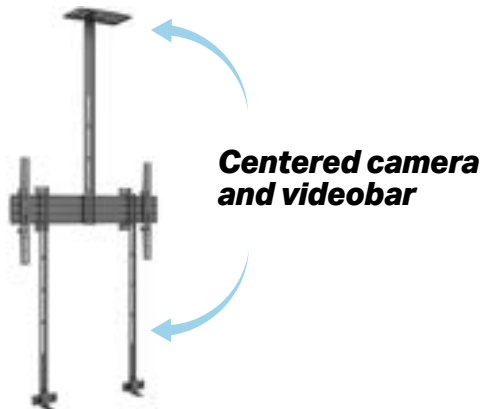

Collaboration Side by Side 65"



Collaboration Side by Side 75"

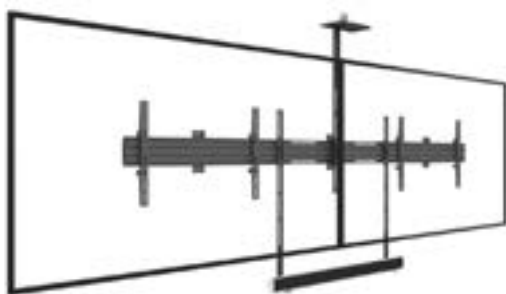

Collaboration Side by Side 90"

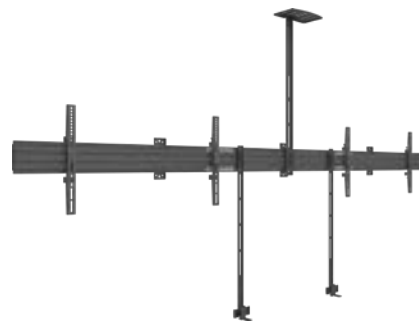

Model name:	Collaboration MBW1U	Collaboration Side by Side 65"	Collaboration Side by Side 75"	Collaboration Side by Side 90"
Screen size:	32" - 75"	32" - 65"	32" - 75"	32" - 90"
VESA:	VESA 400, 40cm	VESA 400, 40cm	VESA 400, 40cm	VESA 400, 40cm
EAN:	735010521 2840	735007373 6621	735007373 8915	735007373 8922
Max load:	70 kg	30 kg (Per screen)	70 kg (Per screen)	70 kg (Per screen)
Bracket type:	Fixed	Fixed	Fixed	Fixed
Landscape/portrait:	Landscape	Yes	Yes	Yes
Floor support:	No	No	No	No
Wall distance:	40 cm	40 cm	40 cm	40 cm
Colour (VESA arms):	Black	Black	Black	Black
Colour (horizontal rail):	Black (Silver optional)	Black (Silver optional)	Black (Silver optional)	Black (Silver optional)
Warranty:	5 years	5 years	5 years	5 years

Collaboration MBW1U with Floor support



Collaboration Side by Side 65" with Floor support

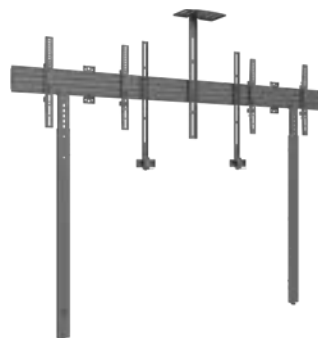

Collaboration Side by Side 75" with Floor support

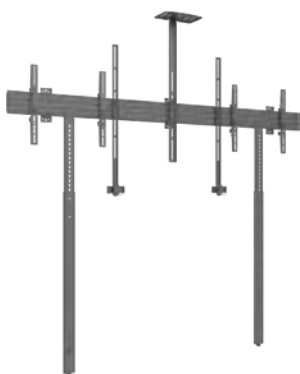

Collaboration Side by Side 90" with Floor support

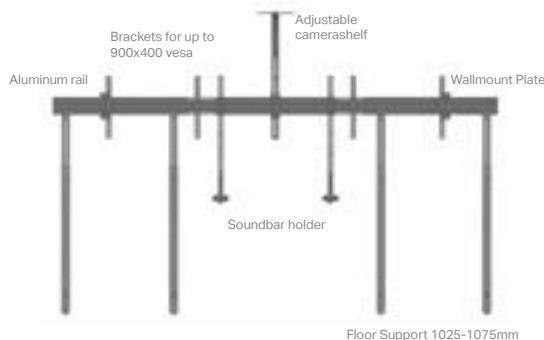

Collaboration Side by Side 75" with Floor support



Collaboration Side by Side 90" with Floor support



Model name:	MBW1U with Floorsupport	SBS 65" with Floorsupport	SBS 75" with Floorsupport	SBS 90" with Floorsupport	MBW2U w Floorsupport	MBW3U w Floorsupport
Screen size:	32" - 75"	32" - 65"	32" - 75"	32" - 90"	32" - 75"	32" - 90"
VESA:	VESA 400, 40cm	VESA 400, 40cm	VESA 400, 40cm	VESA 400, 40cm	VESA 400, 40cm	VESA 400, 40cm
EAN:	735010521 3960	735010521 3977	735010521 3984	735010521 3991	735010521 4011	735010521 4028
Max load:	70 kg	30 kg (Per screen)	70 kg (Per screen)	70 kg (Per screen)	50 kg (Per screen)	50 kg (Per screen)
Bracket type:	Fixed	Fixed	Fixed	Fixed	Fixed	Fixed
Landscape/portrait:	Landscape	Yes	Yes	Yes	Yes	Yes
Floor support:	Yes	Yes	Yes	Yes	Yes	Yes
Wall distance:	1025-1705mm	1025-1705mm	1025-1705mm	1025-1705mm	1025-1705mm	1025-1705mm
Colour (VESA arms):	Black	Black	Black	Black	Black	Black
Colour (horizontal rail):	Black (Silver optional)	Black (Silver optional)	Black (Silver optional)	Black (Silver optional)	Black (Silver optional)	Black (Silver optional)
Warranty:	5 years	5 years	5 years	5 years	5 years	5 years



Pro Series Communication Stations

Introducing the M Floorstand Pro MBF1U 150 - a flat panel TV cart designed with every essential feature, making it a versatile choice for any application.

Mobility, sleek design, adjustable display height, a pre-assembled base, and full safety certifications ensure quick setup and reliable performance. Combining strength with

modern aesthetics, this floorstand delivers a sturdy yet elegant solution that fits seamlessly into any environment.



Highlights:

- Mobile and ultra flexible
- Integrated cable management
- All parts provides rigidity, stability and quick assembly
- Textured black powder coat finish
- Universal and extendable mounting up to VESA 1000x900mm
- If your needs change reconfigure your floorstand
- 5-year warranty

MBF1UXL 270



270cm
Height adjustment



Side by Side 65"



Side by Side 75"



Side by Side 90"



Model name:	MBF1UXL 270	Side by Side 65"	Side by Side 75"	Side by Side 90"
Screen size:	98"-110"	40"-65"	40"-65"	40"-65"
VESA:	1000x600	VESA 400, 40cm	VESA 400, 40cm	VESA 400, 40cm
EAN:	735010521 7111	735010521 6183	735010521 6190	735010521 6206
Max load:	50kg	30kg (Per screen)	30kg (Per screen)	30kg (Per screen)
Bracket type:	Fixed (Tilt optional)	Fixed (Tilt optional)	Fixed (Tilt optional)	Fixed (Tilt optional)
Landscape/portrait:	Yes	Yes	Yes	Yes
Floor support:	270 cm	180 cm	180 cm	300 cm
Wall distance:	Black	Black	Black	Black
Colour (VESA arms):	Black (Silver optional)	Black (Silver optional)	Black (Silver optional)	Black (Silver optional)
Colour (horizontal rail):	Black	Black	Black	Black
Warranty:	5 years	5 years	5 years	5 years

M Floorstand Pro MBF1U 150



M Floorstand Pro MBF1U 180



M Floorstand Pro MBFSC1U 180 Fixed 1600X600



M Floorstand Pro MBFSC1U 270 Fixed 1600X600



Model:	M Floorstand Pro MBF1U 150	M Floorstand Pro MBF1U 180	M Floorstand Pro MBFSC1U 180 Fixed 1600X600	M Floorstand Pro MBFSC1U 270 Fixed 1600X600
Screen size:	65"-100"	65"-100"	65"-100"	65"-100"
Feature:	Large screen capacity	Large screen capacity	Large screen capacity	Large screen capacity
Max VESA:	1000 x 600 mm	1000 x 600 mm	1600 x 600 mm	1600 x 600 mm
VESA standard:	100x100 200x200 300x300 400x400 600x400 800x400 1000x400 600x600 800x600 1000x600	100x100 200x200 300x300 400x400 600x400 800x400 1000x400 600x600 800x600 1000x600	100x100 200x200 300x300 400x400 600x400 800x400 1000x400 600x600 800x600 1000x600 1600x600	100x100 200x200 300x300 400x400 600x400 800x400 1000x400 600x600 800x600 1000x600 1600x600
EAN:	735007373 9103	735007373 9110	735002273 8454	735010521 7111
Adjustable height:	10 mm height adjustment	10 mm height adjustment	10 mm height adjustment	10 mm height adjustment
Weight:	15kg & 24kg	18kg & 24kg	41 kg	24,5 kg + 40 kg
Colour:	Black	Black	Black	Black
Max load:	90 kg	90 kg	90 kg	90 kg
DVD Shelf / Camera holder:	Included	Included	Included	Included
Screen position:	Landscape	Landscape	Landscape	Landscape
Wheels:	Included	Included	Included	Included
Warranty:	5 years	5 years	5 years	5 years



Tripod

Monitor stands

The M Pro Series Tripod Stand is a premium floor-stand solution engineered for professional signage and display applications. With a focus on modularity and ease of deployment, this range offers a robust tripod base, refined Scandinavian aesthetics, and the flexibility to adapt to a variety of environments, from retail spaces

and event venues to corporate foyers and trade-show booths.

Every model in the series is built for quick, reliable installation: the tripod structure delivers stable support, the rail and mount system is fully configurable, and built-in cable management ensures a clean, high-end presentation. From

single-screen setups to complex display configurations, the Pro Series Tripod Stand accommodates evolving display needs while maintaining a unified visual and installation approach.

Tripod Stand VESA 75/100



Tripod Stand 27"-43" VESA 200



Tripod Stand 32"-55" VESA 300



Tripod Stand 32"-75"



Tripod Stand 32"-75" B2B



	Tripod Stand VESA 75/100	Tripod Stand 27"-43" VESA 200	Tripod Stand 32"-55" VESA 300	Tripod Stand 32"-75"	Tripod Stand 32"-75" B2B
EAN:	735010521 8347	735010521 8323	735010521 8330	735010521 7425	735010521 7432
Color:	Black	Black	Black	Black	Black
Screen size:	27" - 43"	27" - 43"	32" - 55"	32" - 75"	32" - 75"
VESA:	Max 100x100	Max 400x600	Max 400x300	Max 400x400	Max 400x400
Material:	Steel, Aluminium, Plastic	Steel, Aluminium, Plastic	Steel, Aluminium, Plastic	Steel, Aluminium, Plastic	Steel, Aluminium, Plastic
Surface Finish:	Powder coating	Powder coating	Powder coating	Powder coating	Powder coating
Weight:	11 kg	12,5 kg	12 kg	13 kg	17 kg
Measurements	155 x 23 x 20.7 cm	155 x 23 x 20.7 cm	155 x 23 x 20.7 cm	154.5 x 23 x 23 cm	154.5 x 23 x 23 cm
Max Load:	30 kg per screen	30 kg per screen	30 kg per screen	30 kg per screen	30 kg per screen
Installation:	M Pro Series	M Pro Series	M Pro Series	M Pro Series	M Pro Series
Warranty:	5 years	5 years	5 years	5 years	5 years



Pro Series Floorstands Single Pole

The new range of Pro Series single-pole flat panel floorstands is designed to provide the ideal display viewing placement while blending seamlessly with the décor of any environment.

Perfect for public spaces such as retail stores, training rooms, lobbies, classrooms, auditoriums, or exhibition halls, these stands combine

functionality with a clean, modern appearance.

As with all Pro Series products, a full line-up of accessories is available to tailor functionality to your specific needs. Integrated cable management keeps AV cabling concealed, ensuring a tidy and professional look.





Pro Series Floorstands Dual Pole

The Pro Series Dual Pole floorstands are designed to support one or two large displays, mounted back-to-back in either landscape or portrait orientation.

Combining strength with a clean, modern design, these stands are simple to install yet robust and highly functional — making them ideal for a wide range of applications

such as retail stores, training rooms, lobbies, classrooms, auditoriums, and exhibition halls.

As with all Pro Series solutions, a full line-up of accessories is available to tailor functionality to your specific requirements. Integrated cable management keeps AV wiring hidden, ensuring a neat and professional appearance.



Single Pole Floormount

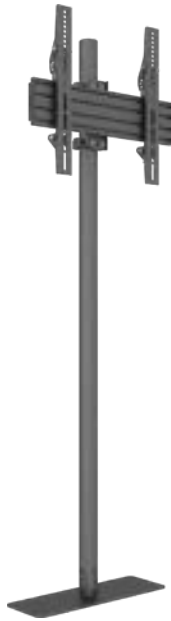



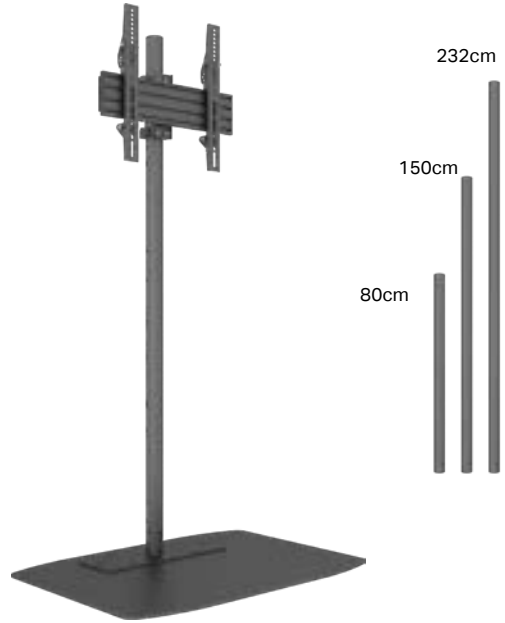

Single Pole Floorbase



Optional round base
EAN: 735010521 7593

Pole colors:

-  Black
-  Chrome
-  White
-  Brass
-  Tailored

	M Single Pole Floormount Pro 32"-65"	M Single Pole Floorbase Pro 32"-65"
EAN:	Black: 7350073738939	Black: 7350073738946
Color:	Black	Black
Optional colour:	Chrome, White, Brass, Tailored	Chrome, White, Brass, Tailored
Color:	Black / Chrome / White	Black / Chrome / White
Screen size:	32"-65"	Steel, Aluminium, Plastic
Universal & VESA standard:	100x100 200x200 300x300 400x400	100x100 200x200 300x300 400x400
Material:	Steel, Aluminium, Plastic	Steel, Aluminium, Plastic
Surface Finish:	Powder coating	Powder coating
Weight:	11 kg	25 kg 11 kg
Measurements	160*18*15 cm	90x62x4 & 160x18x15 cm
Max Load:	50 kg per screen	50 kg per screen
Height:	10 mm height adjustment	10 mm height adjustment
Tilt:	-6°~+15°	-6°~+15°
Warranty:	5 years	5 years

Single Pole Floorbase



Single Pole Floorbase B2B



Floorbase Round VESA 50/75/100/200



Floorbase Round VESA 50/75/100/200 B2B



Floormount Pole 50/75/100/200 B2B



Model name:	M Pro Series Single Pole Floorbase	M Pro Series Single Pole Floorbase B2B	M Single Pole Floorbase Round VESA 50/75/100/200	M Single Pole Floorbase Round VESA 50/75/100/200 B2B	Floormount Pole 50/75/100/200 B2B
Screen size:	7" - 30"	10" - 30"	32" - 55"	32" - 55"	32" - 55"
VESA:	75x75,100x100	75x75, 100x100	50x50 to 200x200	50x50 to 200x200	100x100 to 200x200
EAN:	7350105210549	735010521 3069	735010521 9085	735010521 9108	735010521 9917
Max load:	10 kg	10 kg per screen	50 kg per screen	50 kg per screen	45 kg per screen
Bracket type:	Tilt	Tilt	Fixed	Fixed	Fixed
Floormount:	Yes	Yes	Yes	Yes	Yes
Floorstand:	Yes (floorbase included)	Yes (floorbase included)	Yes (floorbase included)	Yes (floorbase included)	Yes (floorbase included)
Landscape/portrait:	Yes	Yes	Portrait	Portrait	Yes
Pole height:	1000 mm	1000 mm	1513 mm	1513 mm	1513 mm
Colour:	Black	Black	Black	Black	Black
Warranty:	5 years	5 years	5 years	5 years	5 years

Floorbase Round VESA 400



Floorbase Round 32"- 65" VESA 400

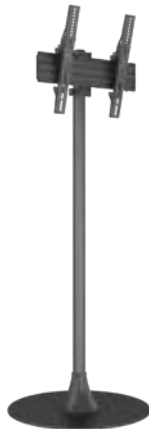

Floorbase Round 32"- 65" VESA 600

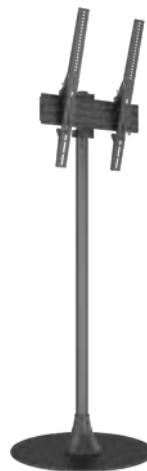

Floorbase Round 32"- 65" VESA 400 B2B



Floormount Pro 32"-65" VESA 600



Model name:	M Single Pole Floorbase Round 32"- 65" VESA 400	M Single Pole Floorbase Round 32"- 65" VESA 400	M Single Pole Floorbase Round 32"- 65" VESA 600	M Single Pole Floorbase Round 32"- 65" VESA 400 B2B	M Single Pole Floormount Pro 32"-65" VESA 600
EAN:	735010521 9092	735010521 8354	735010521 8361	735002273 8232	734023481 0147
Colour:	Black	Black	Black	Black	Black
Screen size:	32"-65"	32"-65"	32"-65"	32"-65"	32"-65"
VESA:	200x200, 300x300, 400x400mm	100x100 200x200 300x300, 400x400	100x100, 200x200 300x300, 400x400, 400x600	100x100, 200x200, 300x300, 400x400	100x100, 200x200, 300x300, 400x400, 600x400
Material:	Steel, Aluminium, Plastic	Steel, Aluminium, Plastic	Steel, Aluminium, Plastic	Steel, Aluminium, Plastic	Steel, Aluminium, Plastic
Surface finish:	Powder coating	Powder coating	Powder coating	Powder coating	Powder coating
Weight:	18.3kg + 2.9kg	21.9 kg	22.4 kg	23.7 kg	23.7 kg
Measurements:	62.5x62.1x16.8cm + 154x5.7x5.8cm	63.6x63x17.8cm, 154.5x16x11.6cm	63.6x63x17.8cm, 154.5x16x11.6cm	63.6x63x17.8cm, 154.5x16x11.6cm	69.2x16x8.8cm, 154.5x5.7x5.8cm
Max load:	50 kg	50 kg	50 kg	50 kg	50 kg
Height:	1513 mm	1513 mm	1513 mm	1513 mm	1513 mm
Tilt:	-	-6°~+15°	-6°~+15°	-6°~+15°	-6°~+15°
Warranty:	5 years	5 years	5 years	5 years	5 years

M Dual Pole Floormount Pro 65"-90"



M Dual Pole Floorbase Pro 65"-90"



M Dual Pole Floormount Pro B2B 65"-90"



M Dual Pole Floorbase Pro B2B 65"-90"



	M Dual Pole Floormount Pro	M Dual Pole Floorbase Pro	M Dual Pole Floormount Pro B2B	M Dual Pole Floorbase Pro B2B
EAN:	7350073738953	7350073738960	7350073738977	7350073738984
Color:	Black	Black	Black	Black
Optional colour:	Chrome, White, Brass, Tailored	Chrome, White, Brass, Tailored	Chrome, White, Brass, Tailored	Chrome, White, Brass, Tailored
Screen size:	65"-90"	65"-90"	65"-90"	65"-90"
VESA:	100x100 200x200 300x300 400x400 400x600	100x100 200x200 300x300 400x400 400x600	100x100 200x200 300x300 400x400 400x600	100x100 200x200 300x300 400x400 400x600
Material:	Steel, Aluminium, Plastic	Steel, Aluminium, Plastic	Steel, Aluminium, Plastic	Steel, Aluminium, Plastic
Surface Finish:	Powder coating	Powder coating	Powder coating	Powder coating
Weight:	15.7 kg	15.7 kg & 25 kg	21 kg	21KG&25 kg
Measurements	160*18*15 cm	160*18*15 & 90*62*4 cm	160*18*15 cm	160*18*15 & 90*62*4 cm
Max Load:	75 kg per screen	75 kg per screen	75 kg per screen	75 kg per screen
Height:	10 mm height adjustment	10 mm height adjustment	10 mm height adjustment	10 mm height adjustment
Tilt:	-6°~+15°	-6°~+15°	-6°~+15°	-6°~+15°
Warranty:	5 years	5 years	5 years	5 years



Triple and Quad Floorstands

The Pro Series modular floorstand system is designed to support one, two, three, or more screens, mounted in virtually any configuration, landscape or portrait.

Easy to install and highly adaptable, these floorstands combine a clean, modern design with robust functionality, making them ideal for a wide range of applications such as retail

stores, training rooms, lobbies, classrooms, auditoriums, and exhibition halls.

Like all Pro Series products, they are supported by a full line-up of accessories,

allowing you to tailor functionality to your exact requirements. Integrated cable management keeps AV cabling concealed, ensuring a tidy and professional appearance.

Triple Pro MBF3U

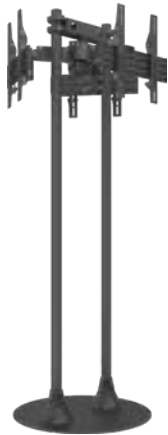

Triple Pro AddOn MBF3U

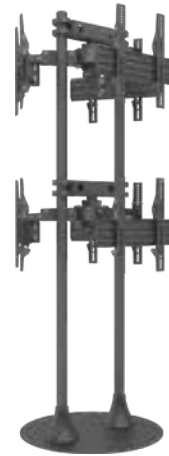

Quad Pro MBF4U

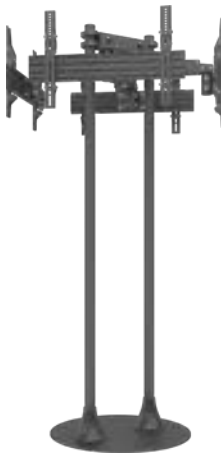

Quad Pro AddOn MBF4U



	Model: MBFC1U 150cm	MBFC1U 180cm	MBFC1U 270cm	MBFMC3x1U
Screen size:	32" - 65"	32" - 65"	32" - 65"	32" - 65"
VESA:	VESA 400, 40cm	VESA 400, 40cm	VESA 400, 40cm	VESA 400, 40cm
EAN:	735007373 7697	735007373 7703	735007373 7710	735007373 7727
Max load:	30 kg (Per screen)	30 kg (Per screen)	30 kg (Per screen)	30 kg (Per screen)
Bracket type:	Tilt	Tilt	Tilt	Tilt
Landscape / portrait:	Yes	Landscape	Yes	Landscape
Pole length:	200 cm	200 cm	200 cm	200 cm
Colour (VESA arms):	Black	Black	Black	Black
Optional colour:	Chrome, White, Brass, Tailored	Chrome, White, Brass, Tailored	Chrome, White, Brass, Tailored	Chrome, White, Brass, Tailored
Warranty	5 years	5 years	5 years	5 years
Accessories:	Cover plate	Cover plate	Cover plate	Cover plate



Pro Series Floorstand line up

The Pro Series modular floorstand system is designed to support one, two, three, or more screens in virtually any configuration - landscape or portrait. Simple to install yet robust and highly functional, the Dual Pole series combines

clean, modern design with the strength needed for demanding environments. These floorstands provide the ideal viewing placement while blending seamlessly into any décor. Perfect for public areas such as retail

stores, training rooms, lobbies, classrooms, auditoriums, or exhibition halls, the Pro Series delivers both versatility and style. As with all Pro Series solutions, a complete line-up of accessories is available to customize functionality to

your specific needs. Integrated cable management conceals AV cabling, ensuring a neat and professional finish.

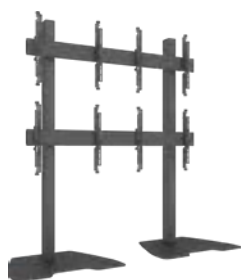

Floorbase



Floormount



Wheelbase

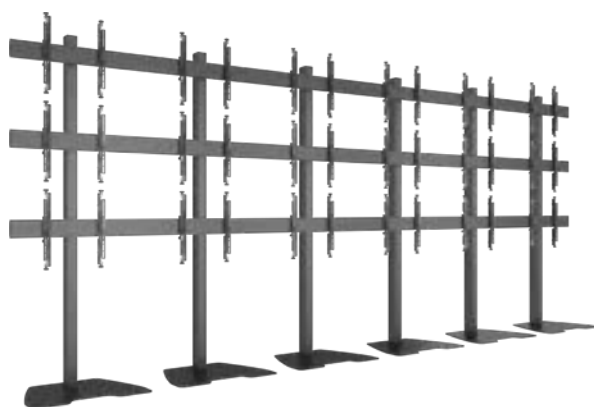

Model:	MBFC3UX3 Micro Adjustable
Screen size:	43"-65"
VESA:	VESA 400, 40cm
EAN:	7350105216824
Max load:	30kg (Per screen)
Bracket type:	Micro Adjustable
Landscape / portrait:	Portrait
Pillar length:	300 cm
Colour (VESA arms):	Black
Colour (Horizontal rail):	Black (Silver optional)
Colour (Pillar):	Black
Warranty:	5 years

Freestanding Video Walls

for any environment

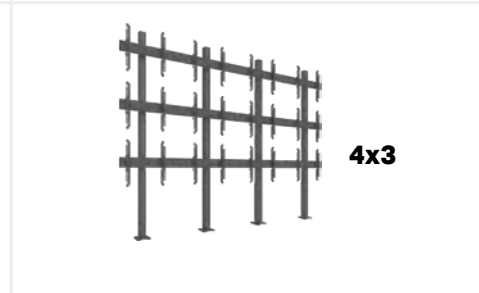
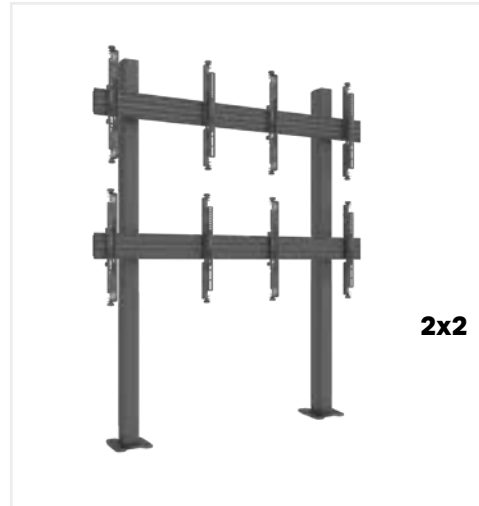
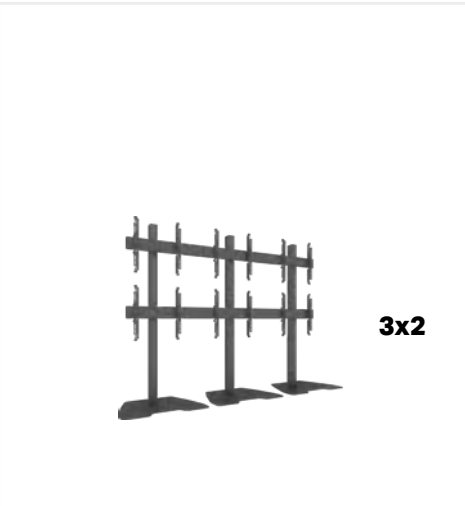
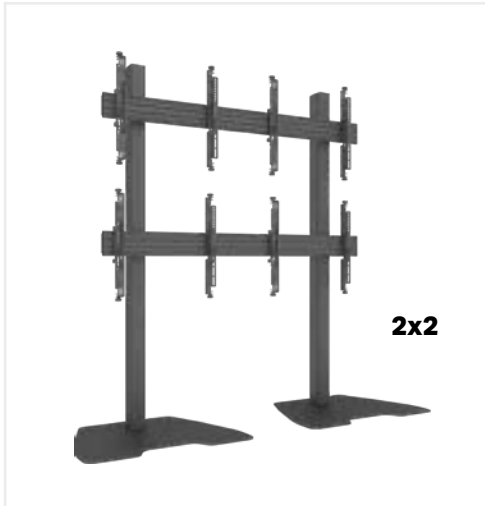

Videowall Stands

Floormounts

Create striking video walls with the Pro Series Video Wall Mounting System. Designed for landscape or portrait use, it supports 32"-65" displays and can expand as your needs change. Sturdy aluminum columns (180, 270,

or 300 cm) allow adjustable viewing height for seated or standing audiences. Choose a movable wheelbase or fixed base, ideal for presentations, trade shows, retail, or offices. Built for durability and easy servicing, it's a cost-efficient

solution for digital signage, videoconferencing, and professional use. Displays can be added or removed over time, and the system can be relocated or floor-mounted for permanent setups. Independent height, depth,

and lateral adjustments ensure precise, seamless alignment every time.

Fully configurable

Adapt the setup over time with flexible parts and adjustments

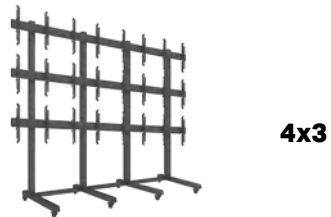
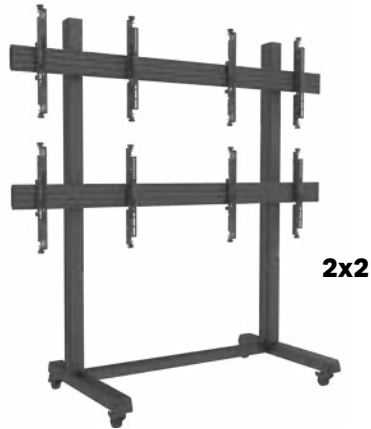

Wheelbased

Highlights:

- Floorbase, floormount or wheelbase
- Permanent bolt-down possible
- Integrated cable management
- Change design after new needs occur

MBFSC1U 180 Micro Adjustable



MBFSC2U 180 Micro Adjustable

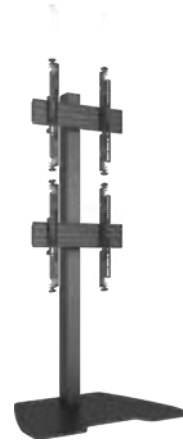

MBFSC1U 270 Micro Adjustable

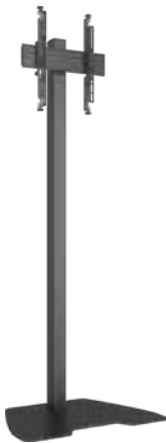

MBFSC2U 270 Micro Adjustable



MBFSC3U 270 Micro Adjustable



	MBFSC1U 180 Micro Adjustable	MBFSC2U 180 Micro Adjustable	MBFSC1U 270 Micro Adjustable	MBFSC2U 270 Micro Adjustable	MBFSC3U 270 Micro Adjustable
Model:	MBFSC1U 180 Micro Adjustable	MBFSC2U 180 Micro Adjustable	MBFSC1U 270 Micro Adjustable	MBFSC2U 270 Micro Adjustable	MBFSC3U 270 Micro Adjustable
Screen size:	43" - 65"	43" - 65"	43" - 65"	43" - 65"	43" - 65"
VESA:	VESA 400, 40cm	VESA 400, 40cm	VESA 400, 40cm	VESA 400, 40cm	VESA 400, 40cm
EAN:	735010521 4103	735002273 6764	735010521 4110	735010521 5612	735002273 6757
Max load:	30kg	30kg (Per screen)	30kg (Per screen)	30kg (Per screen)	30kg (Per screen)
Bracket type:	Micro Adjustable	Micro Adjustable	Micro Adjustable	Micro Adjustable	Micro Adjustable
Landscape / portrait:	Yes	Landscape	Yes	Landscape	Landscape
Pillar length:	180cm	180cm	270cm	270cm	270cm
Colour (VESA arms):	Black	Black	Black	Black	Black
Colour (Horizontal rail):	Black (Silver optional)	Black (Silver optional)	Black (Silver optional)	Black (Silver optional)	Black (Silver optional)
Colour (Pillar):	Black	Black	Black	Black	Black
Warranty:	5 years	5 years	5 years	5 years	5 years

MBFSC1U 300



MBF2x1U



MBF2x3U

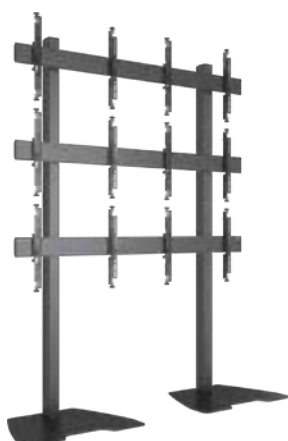

MBF3x1U

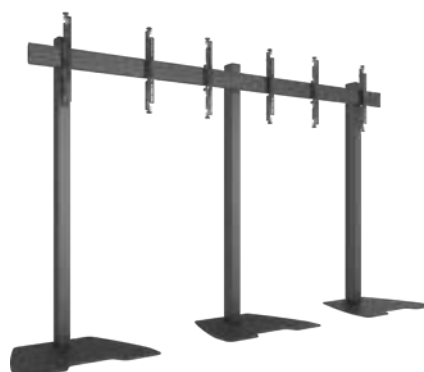

	Model: MBFSC1U 300	MBF2x1U	MBF2x3U	MBF3x1U
Screen size:	43" - 110"	43"-65"	43"-65"	43"-65"
VESA:	1600x600mm	VESA 400, 40cm	VESA 400, 40cm	VESA 400, 40cm
EAN:	735010521 6749	735010521 3496	735010521 3502	735010521 3519
Max load:	80kg	125kg	30kg (Per screen)	30kg (Per screen)
Bracket type:	Fixed (Tilt optional)	Micro Adjustable	Micro Adjustable	Micro Adjustable
Landscape / portrait:	Yes	Yes	Portrait	Yes
Pillar length:	270 cm	180 cm	300 cm	180 cm
Colour (VESA arms):	Black	Black	Black	Black
Colour (Horizontal rail):	Black (Silver optional)	Black (Silver optional)	Black (Silver optional)	Black (Silver optional)
Colour (Pillar):	Black	Black	Black	Black
Warranty:	5 years	5 years	5 years	5 years

MBF3x2U

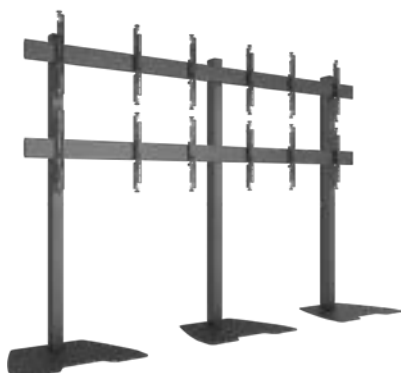

MBFC3UX3

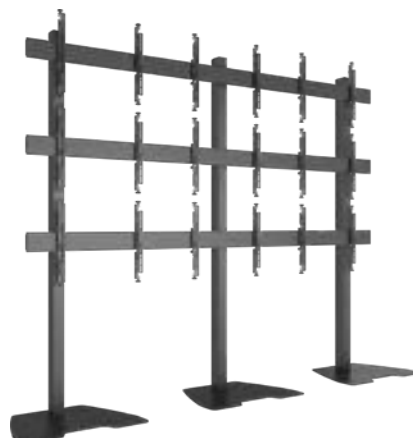

MBFSC6U 180 VESA 75/100



MBFSC9U 180 VESA 75/100



	Model: MBF3x2U	MBFC3UX3	MBFSC6U 180 VESA 75/100	MBFSC9U 180 VESA 75/100
Screen size:	43"-65"	43"-65"	50"-55"	32" 43" 55"
VESA:	VESA 400, 40cm	VESA 400, 40cm	75x75, 100x100mm	75x75, 100x100mm
EAN:	735010521 3526	735010521 3533	734023481 0178	734023481 0185
Max load:	30kg (Per screen)	30kg (Per screen)	30kg (Per screen)	30kg (Per screen)
Bracket type:	Micro Adjustable	Micro Adjustable	Tilt (Fixed optional)	Tilt (Fixed optional)
Landscape / portrait:	Yes	Yes	Landscape	Yes
Pillar length:	180 cm	300 cm	180 cm	180 cm
Colour (VESA arms):	Black	Black	Black	Black
Colour (Horizontal rail):	Black (Silver optional)	Black (Silver optional)	Black (Silver optional)	Black (Silver optional)
Colour (Pillar):	Black	Black	Black	Black
Warranty:	5 years	5 years	5 years	5 years

Video Wall Floorbase MBFMC3X2U Micro Adjustable



Video Wall Floorbase MBFMC4X2U Micro Adjustable



Video Wall Floorbase MBFMC5X2U Micro Adjustable

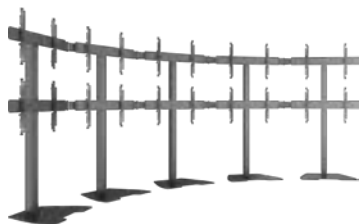

Video Wall Floorstand MBFMC7X1UXL VESA 600



Video Wall Floorstand MBFMC7X1UXL VESA 900

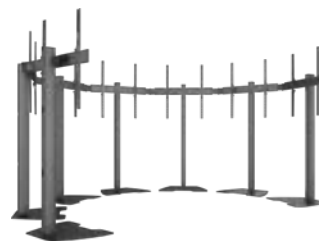

Model:	Video Wall Floorbase MBFMC3X2U Micro Adjustable	Video Wall Floorbase MBFMC4X2U Micro Adjustable	Video Wall Floorbase MBFMC5X2U Micro Adjustable	Video Wall Floorstand MBFMC7X1UXL VESA 600	Video Wall Floorstand MBFMC7X1UXL VESA 900
Screen size:	65"	65"	65"	86"	86"
VESA:	VESA 400, 40cm	VESA 400, 40cm	VESA 400, 40cm	VESA 600, 60cm	Max 800x900mm
EAN:	735002273 1073	735002273 1080	735010521 8415	735007373 8281	735010521 9726
Max load:	35kg (Per screen)	35kg (Per screen)	35kg (Per screen)	35kg (Per screen)	75kg (Per screen)
Bracket type:	Fixed	Micro Adjustable	Micro Adjustable	Micro Adjustable	Micro Adjustable
Landscape / portrait:	Landscape	Landscape	Landscape	Portrait	Portrait
Pillar length:	150 cm	180 cm	150 cm	150 cm	180 cm
Colour (VESA arms):	Black	Black	Black	Black	Black
Colour (Horizontal rail):	Black (Silver optional)	Black (Silver optional)	Black (Silver optional)	Black (Silver optional)	Black (Silver optional)
Colour (Pillar):	Black	Black	Black	Black	Black
Warranty:	5 years	5 years	5 years	5 years	

Video Wall Stand MBF2x2U 180 Micro Adjustable



Video Wall Stand MBF2x2U 300 Micro Adjustable



Video Wall Stand MBF4x3U 300 Micro Adjustable

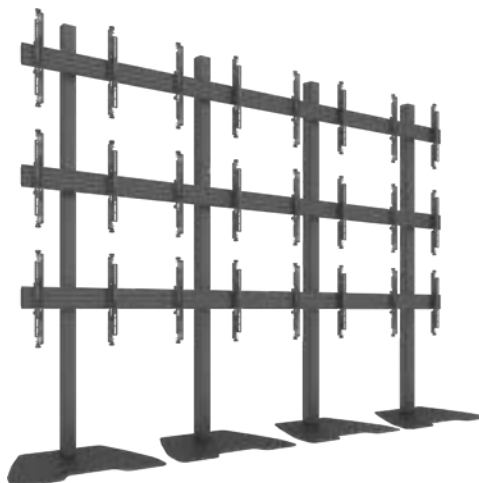

Model:	Video Wall Stand MBF2x2U 180 Micro Adjustable	Video Wall Stand MBF2x2U 300 Micro Adjustable	Video Wall Stand MBF4x3U 300 Micro Adjustable
Screen size:	43"-65"	43"-65"	43"-65"
VESA:	VESA 400, 40cm	VESA 400, 40cm	VESA 400, 40cm
EAN:	735010521 0600	735010521 9238	735002273 8690
Max load:	30kg (Per screen)	30kg (Per screen)	30kg (Per screen)
Bracket type:	Micro Adjustable	Micro Adjustable	Micro Adjustable
Landscape / portrait:	Landscape	Landscape	Landscape
Pillar length:	180 cm	300 cm	300 cm
Colour (VESA arms):	Black	Black	Black
Colour (Horizontal rail):	Black (Silver optional)	Black (Silver optional)	Black (Silver optional)
Colour (Pillar):	Black	Black	Black
Warranty:	5 years	5 years	5 years

M Floorstand Column Pro MBFSC1U 60 Tilt Up

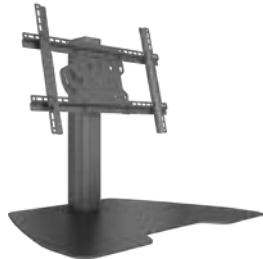

M Floorstand Column Pro MBFSC1U 100 Tilt Up



M Floorstand Column Pro MBFSC1U 120 Tilt Up

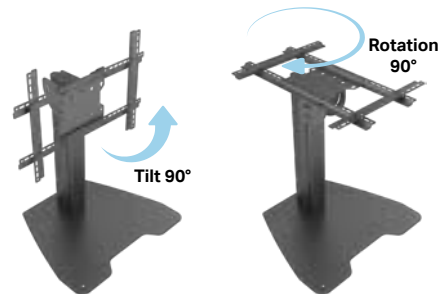

	M Floorstand Column Pro MBFSC1U 60 Tilt Up	M Floorstand Column Pro MBFSC1U 100 Tilt Up	M Floorstand Column Pro MBFSC1U 120 Tilt Up
Model:	M Floorstand Column Pro MBFSC1U 60 Tilt Up	M Floorstand Column Pro MBFSC1U 100 Tilt Up	M Floorstand Column Pro MBFSC1U 120 Tilt Up
EAN:	735002273 7037	735002273 7044	735002273 7051
Screen size:	32" - 55"	32" - 75"	32" - 75"
VESA:	VESA 600, 60cm	VESA 600, 60cm	VESA 600, 60cm
Max load:	70 kg	70 kg	70 kg
Bracket type:	Tilt	Tilt	Tilt
Landscape / portrait:	Yes	Yes	Yes
Pillar length:	60 cm	100 cm	120 cm
Colour (VESA arms):	Black	Black	Black
Colour (Horizontal rail):	Black (Silver optional)	Black (Silver optional)	Black (Silver optional)
Colour (Pillar):	Black	Black	Black
Warranty:	5 years	5 years	5 years

MBFSC2U 180 VESA 75/100



MBFSC4U 180 VESA 75/100



MBFSC2U 180 VESA 75/100



MBFSC3U 180 VESA 75/100



MBFSC4U 180 VESA 75/100



Model name:	MBFSC2U 180 VESA 75/100	MBFSC4U 180 VESA 75/100	MBFSC2U 180 VESA 75/100	MBFSC3U 180 VESA 75/100	MBFSC4U 180 VESA 75/100
Screen size:	17"-32"	17"-32"	17"-32"	17"-32"	17"-32"
VESA:	75 / 100mm	75 / 100mm	75 / 100mm	75 / 100mm	75 / 100mm
EAN:	735002273 9048	735002273 9055	734023481 0314	735002273 9062	734023481 0321
Max load:	10kg (Per screen)	10kg (Per screen)	10kg (Per screen)	10kg (Per screen)	10kg (Per screen)
Bracket type:	Tilt (Fixed optional)	Tilt (Fixed optional)	Tilt (Fixed optional)	Tilt (Fixed optional)	Tilt (Fixed optional)
Landscape / portrait:	Yes	Yes	Yes	Yes	Yes
Pillar length:	180 cm	180 cm	180 cm	180 cm	180 cm
Colour (VESA arms):	Black	Black	Black	Black	Black
Colour (Horizontal rail):	Black (Silver optional)	Black (Silver optional)	Black (Silver optional)	Black (Silver optional)	Black (Silver optional)
Colour (Pillar):	Black	Black	Black	Black	Black
Warranty:	5 years	5 years	5 years	5 years	5 years

MBFSC1U 180 Fixed 1000x600



MBFSC1U 270 Fixed 1200x600



MBFSC3U 180 Micro Adjustable

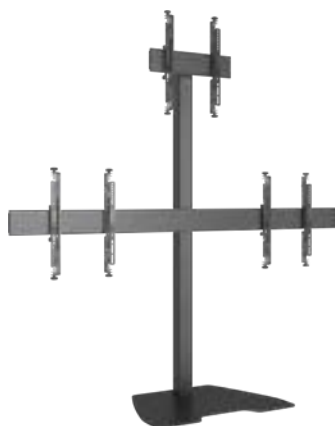

Video Wall Stand MBF3U Art

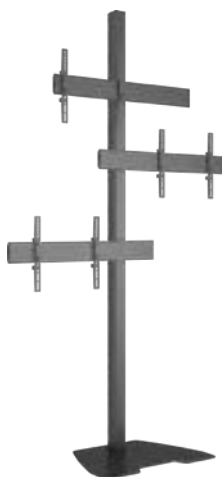

Video Wall Stand MBF6U Art

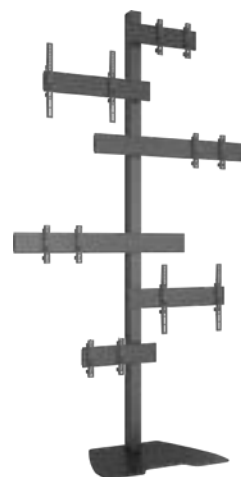

	Model name: MBFSC1U 180 Fixed 1000x600	MBFSC1U 270 Fixed 1200x600	MBFSC3U 180 Micro Adjustable	Video Wall Stand MBF3U Art	Video Wall Stand MBF6U Art
Screen size:	75"-98"	75"~110"	43"~65"	50"-55"	32", 43", 55"
VESA:	Max 1000x600mm	Max 1200x600mm	VESA 400, 40cm	VESA 400, 40cm	50x50 / 100x100 / 200x200 / 400x400mm
EAN:	735010521 9566	735010521 9573	735010521 1454	735002273 9079	735002273 2407
Max load:	90kg	90kg	30kg (Per screen)	30kg (Per screen)	30kg (Per screen)
Bracket type:	Fixed (Tilt optional)	Fixed (Tilt optional)	Micro Adjustable	Fixed (Tilt optional)	Fixed (Tilt optional)
Landscape / portrait:	Landscape	Landscape	Landscape	Landscape	Yes
Pillar length:	180 cm	270 cm	180 cm	270 cm	270 cm
Colour (VESA arms):	Black	Black	Black	Black	Black
Colour (Horizontal rail):	Black (Silver optional)	Black (Silver optional)	Black (Silver optional)	Black (Silver optional)	Black (Silver optional)
Colour (Pillar):	Black	Black	Black	Black	Black
Warranty:	5 years	5 years	5 years	5 years	5 years



Large screen Floorstands

The M Floorstand Column Pro MBFSC1UB 270 Fixed 600X1200 is a high-capacity mobile floorstand engineered for extra-large displays up to 110". Designed for professional environments such as trade shows, corporate lobbies, and control rooms, it combines

smart mobility with robust structure and modular flexibility.

With a durable aluminum build and black textured powder coating, this floorstand provides tool-free height adjustment and supports VESA configurations up to 600x1200

mm. Lockable swivel castors ensure smooth transportation and secure positioning, making it ideal for both fixed and mobile use cases.

Its pre-assembled base streamlines installation, while the modular design allows

for ongoing customizations or upgrades. Delivered with a component shelf and camera holder, this solution is tailored for high-demand AV applications such as video conferencing, digital signage, and interactive displays.

M Floorstand Column Pro MBFSC1U 180 Fixed 1000x600



M Floorstand Column Pro MBFSC1U 270 Fixed 1200x600



M Floorstand Column Pro MBFSC1U 300 Fixed 1600x600



M Floorstand Column Pro MBFSC1UB 270 Fixed 600x1200



Model:	M Floorstand Column Pro MBFSC1U 180 Fixed 1000x600	M Floorstand Column Pro MBFSC1U 270 Fixed 1200x600	M Floorstand Column Pro MBFSC1U 300 Fixed 1600x600	M Floorstand Column Pro MBFSC1UB 270 Fixed 600x1200
Screen size:	43" - 110"	43" - 110"	77" - 120"	85" - 115"
VESA:	100x100, 200x200, 300x300, 400x400, 400x600, 600x400, 1000x600, 1200x600, 1600x600.	100x100, 200x200, 300x300, 400x400, 400x600, 600x400, 1000x600, 1200x600.	800x600, 1000x600, 1200x600, 1600x600.	Up to 600x1200 mm.
EAN:	735010521 9566	735010521 9573	735010521 6749	734023481 2493
Max load:	90 kg	90 kg	100 kg	200 kg
Bracket type:	Fixed	Fixed	Fixed	Fixed
Landscape / portrait:	Yes	Yes	Yes	Yes
Pillar length:	1810 mm	1810 mm	3010 mm	2710 mm
Colour (VESA arms):	Black	Black	Black	Black
Colour (Horizontal rail):	Black	Black	Black	Black
Colour (Pillar):	Black	Black	Black	Black
Warranty:	5 years	5 years	5 years	5 years

Curved Solutions



Create tailored installations with Pro Series

The M Pro Series Pole line of brackets makes it easy to design customized curved installations, mixing computer monitors with digital signage displays in virtually any configuration. Offering a wide range of flexible solutions with tilt and turn functionality, the system provides both adaptability and precision.

With clean Scandinavian design, durable construction, and straightforward installation, these brackets deliver a professional finish for any environment. Each solution comes complete with all necessary hardware for a fast and reliable setup.

Highlights:

- **Works with most screens the market has to offer**
- **Fast & accurate assembly & installation**
- **Simple access & quick rear service**



Ceiling mount

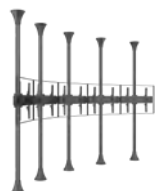

Floor to ceiling



Wheelbase



Floor mounted

MBFC1U 150cm



MBFC1U 180cm

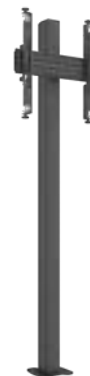

MBFC1U 270cm



MBFMC3x1U



	MBFC1U 150cm	MBFC1U 180cm	MBFC1U 270cm	MBFMC3x1U
Model:	MBFC1U 150cm	MBFC1U 180cm	MBFC1U 270cm	MBFMC3x1U
Screen size:	43" - 50"	43" - 65"	43" - 65"	43" - 65"
VESA:	VESA 400, 40cm	VESA 400, 40cm	VESA 400, 40cm	VESA 400, 40cm
EAN:	735010521 0280	735010521 0297	735010521 0303	735010521 4622
Max load:	30 kg (Per screen)	30 kg (Per screen)	30 kg (Per screen)	30 kg (Per screen)
Bracket type:	Micro Adjustable	Micro Adjustable	Fixed (Tilt optional)	Micro Adjustable
Landscape / portrait:	Yes	Yes	Yes	Yes
Pillar length:	150 cm	180 cm	270 cm	180 / 270 cm
Colour (VESA arms):	Black	Black	Black	Black
Colour (Horizontal rail):	Black (Silver optional)	Black (Silver optional)	Black (Silver optional)	Black (Silver optional)
Colour (Pillar):	Black	Black	Black	Black
Warranty:	5 years	5 years	5 years	5 years

M Floormount Column Pro MBBD1U 60



M Floorstand Column Pro MBBD1U 100



Ideal for store displays!



M Floorstand Column Pro MBBD1U 120

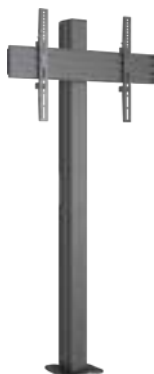

M Floorstand Column Pro MBBD1U 150

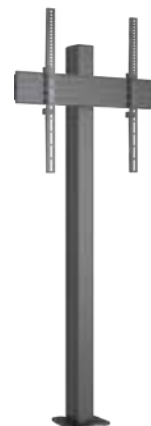

	Model: M Floormount Column Pro MBBD1U 60	M Floorstand Column Pro MBBD1U 100	M Floorstand Column Pro MBBD1U 120	M Floorstand Column Pro MBBD1U 150
Screen size:	75"-98"	75"~110"	50"-55"	50"-86"
VESA:	Max 600x400mm	Max 600x400mm	Max 600x400mm	Max 600x600mm
EAN:	735010521 9313	735010521 9320	735010521 9337	735010521 9290
Max load:	80kg	80kg	80kg	80kg
Bracket type:	Fixed (Tilt optional)	Fixed (Tilt optional)	Fixed (Tilt optional)	Fixed (Tilt optional)
Landscape / portrait:	Landscape	Yes	Yes	Yes
Pillar length:	60 cm	100 cm	120 cm	150 cm
Colour (VESA arms):	Black	Black	Black	Black
Colour (Horizontal rail):	Black (Silver optional)	Black (Silver optional)	Black (Silver optional)	Black (Silver optional)
Colour (Pillar):	Black	Black	Black	Black
Warranty:	5 years	5 years	5 years	5 years

MBFC2U 180cm



MBFC2U 270cm



MBFC3U 270cm



MBFC3U 300 Micro Adjustable



Model:	MBFC2U 180cm	MBFC2U 270cm	MBFC3U 270cm	MBFC3U 300
Screen size:	43" - 65"	43" - 65"	43" - 65"	43" - 65"
VESA:	VESA 400, 40cm	VESA 400, 40cm	VESA 400, 40cm	VESA 400, 40cm
EAN:	735010521 0310	735010521 0327	735010521 0334	735010521 2567
Max load:	30 kg (Per screen)	30 kg (Per screen)	30 kg (Per screen)	30kg (Per screen)
Bracket type:	Micro Adjustable	Micro Adjustable	Micro Adjustable	Micro Adjustable
Landscape / portrait:	Landscape	Landscape	Landscape	Yes
Pillar length:	180 cm	270 cm	270 cm	300 cm
Colour (VESA arms):	Black	Black	Black	Black
Colour (Horizontal rail):	Black (Silver optional)	Black (Silver optional)	Black (Silver optional)	Black (Silver optional)
Colour (Pillar):	Black	Black	Black	Black
Warranty:	5 years	5 years	5 years	5 years

M Floormount Column Pro MBDC1US 180

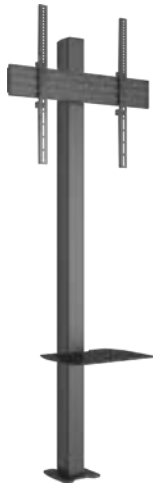

M Floormount Column Pro MBFC1U 180 Fixed 1000x600

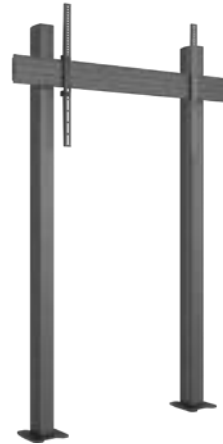

M Floormount Column Pro MBFC1U 270 Fixed 1200x600

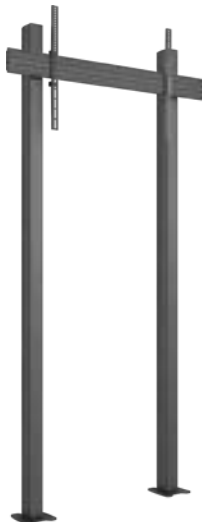

MBFM3x1UP 180 Micro Adjustable



	M Floormount Column Pro MBDC1US 180	M Floormount Column Pro MBFC1U 180 Fixed 1000x600	M Floormount Column Pro MBFC1U 270 Fixed 1200x600	MBFM3x1UP 180 Micro Adjustable
Model:	M Floormount Column Pro MBDC1US 180	M Floormount Column Pro MBFC1U 180 Fixed 1000x600	M Floormount Column Pro MBFC1U 270 Fixed 1200x600	MBFM3x1UP 180 Micro Adjustable
Screen size:	50"-86"	75"-98"	75"~110"	55"-65"
VESA:	Max 600x600mm	Max 1000x600mm	Max 1200x600mm	Max 400x600mm
EAN:	735010521 9306	735010521 9542	735010521 9559	735010521 8842
Max load:	80kg	90kg	90kg	30kg (Per screen)
Bracket type:	Fixed (Tilt optional)	Fixed (Tilt optional)	Fixed (Tilt optional)	Fixed (Tilt optional)
Landscape / portrait:	Yes	Landscape	Yes	Yes
Pillar length:	180 cm	180 cm	270 cm	180 cm
Colour (VESA arms):	Black	Black	Black	Black
Colour (Horizontal rail):	Black (Silver optional)	Black (Silver optional)	Black (Silver optional)	Black (Silver optional)
Colour (Pillar):	Black	Black	Black	Black
Warranty:	5 years	5 years	5 years	5 years

MBFMC3x1U

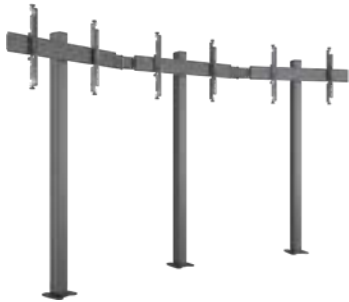

MBFMC3x2U

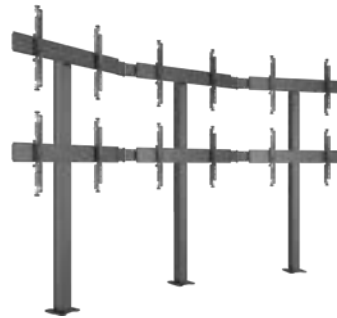

MBFMC3x3U

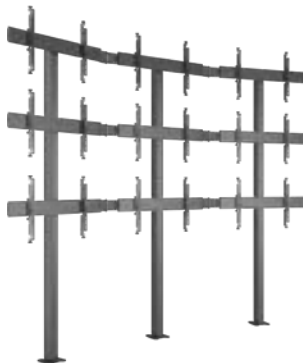

MBFMC6x3U



	MBFMC3x1U	MBFMC3x2U	MBFMC3x3U	MBFMC6x3U
Model:	MBFMC3x1U	MBFMC3x2U	MBFMC3x3U	MBFMC6x3U
Screen size:	43" - 65"	43" - 65"	43" - 65"	43" - 65"
VESA:	VESA 400, 40cm	VESA 400, 40cm	VESA 400, 40cm	VESA 400, 40cm
EAN:	735010521 4622	735010521 4639	735010521 4646	735010521 4653
Max load:	30 kg (Per screen)	30 kg (Per screen)	30 kg (Per screen)	30 kg (Per screen)
Bracket type:	Micro Adjustable	Micro Adjustable	Fixed (Tilt optional)	Micro Adjustable
Landscape / portrait:	Landscape	Yes	Yes	Yes
Pillar length:	180 cm	180 cm	270 cm	270 cm
Colour (VESA arms):	Black	Black	Black	Black
Colour (Horizontal rail):	Black (Silver optional)	Black (Silver optional)	Black (Silver optional)	Black (Silver optional)
Colour (Pillar):	Black	Black	Black	Black
Warranty:	5 years	5 years	5 years	5 years

Video Wall Floormount MBFMC7x1U VESA 600

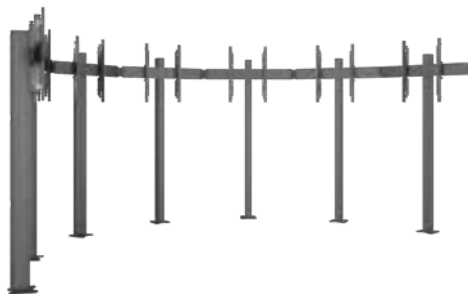

Video Wall Floormount MBFMC4x2U

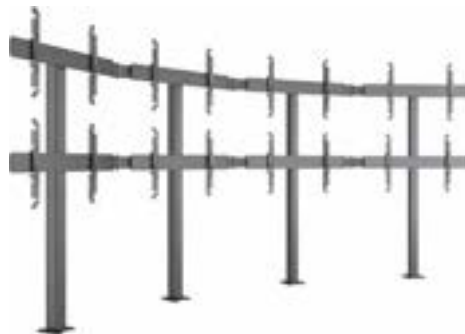

Video Wall Floormount MBFMC5x2U

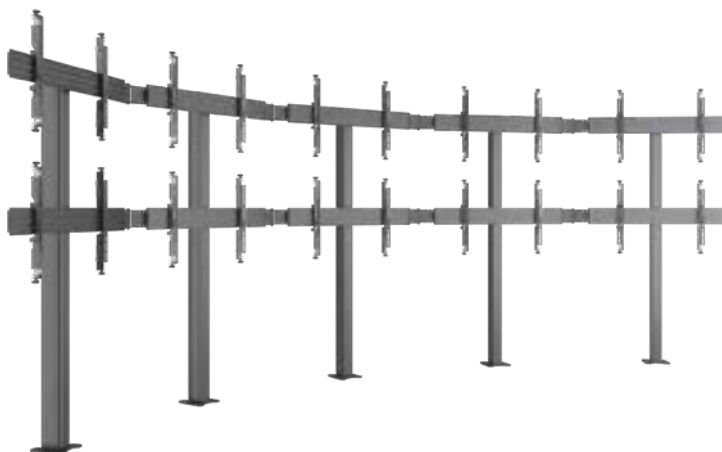

Model:	Video Wall Floormount MBFMC7x1U VESA 600	Video Wall Floormount MBFMC4x2U	Video Wall Floormount MBFMC5x2U
Screen size:	75"	75"	86"
VESA:	VESA 600, 60cm	VESA 400, 40cm	VESA 400, 40cm
EAN:	735010521 7456	735002273 1097	735002273 1103
Max load:	35kg (Per screen)	35kg (Per screen)	35kg (Per screen)
Bracket type:	Micro Adjustable	Micro Adjustable	Micro Adjustable
Landscape / portrait:	Portrait	Landscape	Landscape
Pillar length:	180 cm	180 cm	180 cm
Colour (VESA arms):	Black	Black	Black
Colour (Horizontal rail):	Black (Silver optional)	Black (Silver optional)	Black (Silver optional)
Colour (Pillar):	Black	Black	Black
Warranty:	5 years	5 years	5 years

MBFM2x1U 180 Micro Adjustable



MBFM3x1U 180 Micro Adjustable

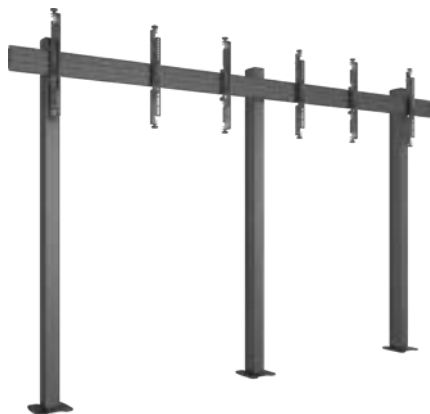

MBFM4x2U 270 Micro Adjustable

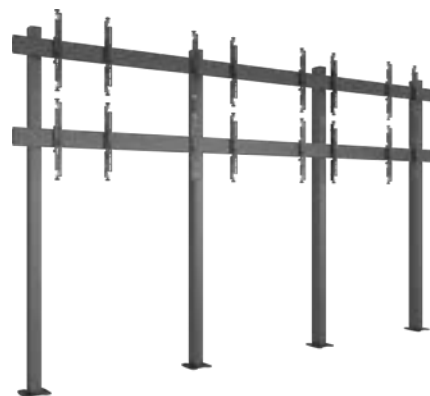

	MBFM2x1U 180 Micro Adjustable	MBFM3x1U 180 Micro Adjustable	MBFM4x2U 270 Micro Adjustable
Model:	MBFM2x1U 180 Micro Adjustable	MBFM3x1U 180 Micro Adjustable	MBFM4x2U 270 Micro Adjustable
Screen size:	43" - 65"	43" - 65"	43" - 65"
VESA:	VESA 400, 40cm	VESA 400, 40cm	VESA 400, 40cm
EAN:	735010521 3397	735010521 3427	735010521 3618
Max load:	30kg (Per screen)	30kg (Per screen)	30kg (Per screen)
Bracket type:	Micro Adjustable	Micro Adjustable	Micro Adjustable
Landscape / portrait:	Portrait	Yes	Yes
Pillar length:	180 cm	180 cm	270 cm
Colour (VESA arms):	Black	Black	Black
Colour (Horizontal rail):	Black (Silver optional)	Black (Silver optional)	Black (Silver optional)
Colour (Pillar):	Black	Black	Black
Warranty:	5 years	5 years	5 years

Video Wall Floormount MBFMC3X1U

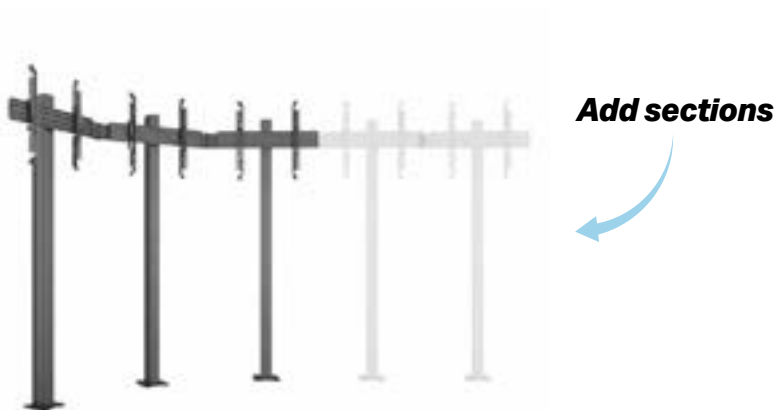

Video Wall Floorstand MBFMC20X1U VESA 400

Video Wall Floorstand MBFMC30X2U VESA 400

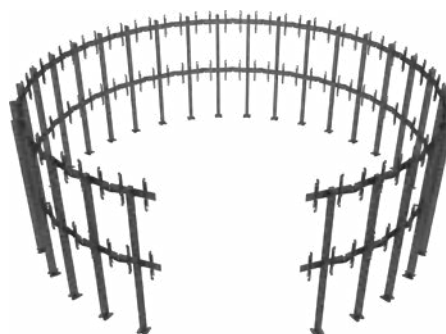
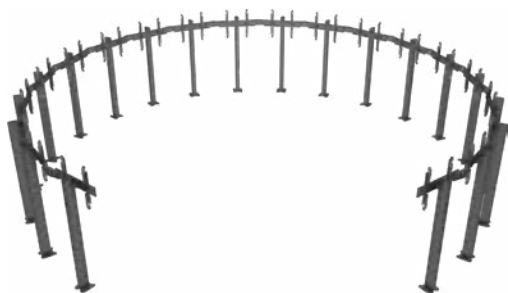

Model:	Video Wall Floormount MBFMC3X1U	Video Wall Floorstand MBFMC20X1U VESA 400	Video Wall Floorstand MBFMC30X2U VESA 400
Screen size:	55"	65"	65"
VESA:	VESA 400, 40cm	Max 600x400mm	Max 600x400mm
EAN:	735010521 9733	735010521 9818	735010521 9801
Max load:	30kg (Per screen)	30kg (Per screen)	35kg (Per screen)
Bracket type:	Micro Adjustable	Micro Adjustable	Fixed
Landscape / portrait:	Portrait	Portrait	Portrait
Pillar length:	180 cm	150 cm	270 cm
Colour (VESA arms):	Black	Black	Black
Colour (Horizontal rail):	Black (Silver optional)	Black (Silver optional)	Black (Silver optional)
Colour (Pillar):	Black	Black	Black
Warranty:	5 years	5 years	5 years

Large-scale videowall and simulation setups

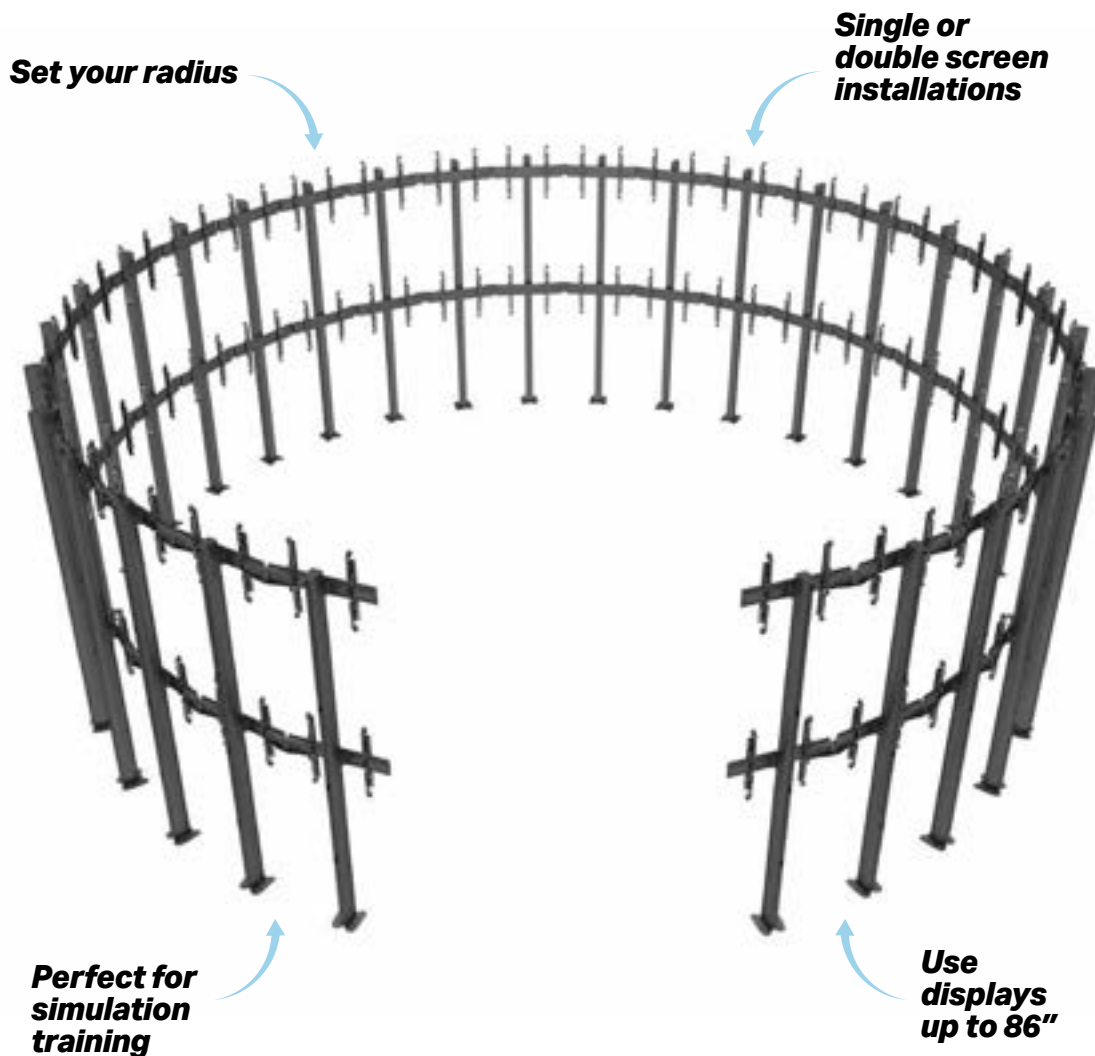

The M Pro Series – Video Wall Floorstand MBFC30X2U VESA 400 is a high-capacity digital signage solution designed for permanent, large-scale video wall installations. Supporting up to 20 screens in a 2x10 (two rows, ten screens wide) layout, this freestanding steel structure is ideal for control rooms, retail

displays, conference centers, and other commercial environments where maximum visual impact and modular flexibility are essential.

Each screen is mounted using micro-adjustable VESA arms that allow fine-tuning on the X, Y, and Z axes, ensuring pixel-per-

fect screen alignment. The robust steel frame combined with modular aluminum rails offers long-term stability, quick installation, and the ability to expand or reconfigure the layout as future needs evolve.

Built-in cable management across the entire structure

ensures clean aesthetics and simplified maintenance, while the Scandinavian-inspired design delivers a sleek, professional look suitable for public display. The bolt-down floor base guarantees a secure, vibration-resistant installation for high-traffic areas.

M Floorstand Column Pro
MBFSC1UW 60 Tilt Up



M Floorstand Column Pro
MBFSC1UW 100 Tilt Up



M Floorstand Column Pro
MBFSC1UW 120 Tilt Up



M Floorstand Pro
MBFS1U 150



M Floorstand Column Pro
MBFSC1UW 150



M Floorstand Pro
MBFS1U 180



M Floorstand Column Pro
MBFSC1UW 180



Model:	M Floorstand Column Pro MBFSC1UW 60 Tilt Up	M Floorstand Column Pro MBFSC1UW 100 Tilt Up	M Floorstand Column Pro MBFSC1UW 120 Tilt Up	M Floorstand Pro MBFS1U 150	M Floorstand Column Pro MBFSC1UW 150	M Floorstand Pro MBFS1U 180	M Floorstand Column Pro MBFSC1UW 180
Screen size:	40"-55"	40"-55"	40"-55"	40"-65"	40"-65"	40"-65"	40"-65"
VESA:	VESA 400, 40cm	VESA 400, 40cm	VESA 400, 40cm	VESA 400, 40cm	VESA 400, 40cm	VESA 400, 40cm	VESA 400, 40cm
EAN:	734023481 2516	734023481 2523	734023481 2530	735007373 8380	735007373 1640	735007373 8397	735007373 1657
Max load:	45 kg	45 kg	45 kg	35kg	30kg, 5kg	30kg	30kg, 5kg
Bracket type:	Tilt	Tilt	Tilt	Fixed	Fixed	Fixed	Fixed
Landscape / portrait:	Yes	Yes	Yes	Yes	Yes	Yes	Yes
Pillar length:	60 cm	100 cm	120 cm	150 cm	180 cm	180 cm	180 cm
Colour (VESA arms):	Black	Black	Black	Black	Black	Black	Black
Colour (Horizontal rail):	Black (Silver optional)	Black (Silver optional)	Black (Silver optional)	Black (Silver optional)	Black (Silver optional)	Black (Silver optional)	Black (Silver optional)
Colour (Pillar):	Black	Black	Black	Black	Black	Black	Black
Warranty:	5 years	5 years	5 years	5 years	5 years	5 years	5 years

M Floorstand Pro MBFS2U 180



Wallmount Fixed MBW1U 900x600 w Floorsupport



M Floorstand Pro MBFS3U 270



M Floorstand Pro MBFS1U 1200



	M Floorstand Pro MBFS2U 180	M Floorstand Pro MBFS3U 270	M Floorstand Pro MBFS1U 900	M Floorstand Pro MBFS1U 1200
Model:	M Floorstand Pro MBFS2U 180	M Floorstand Pro MBFS3U 270	M Floorstand Pro MBFS1U 900	M Floorstand Pro MBFS1U 1200
Screen size:	40"-65"	40"-65"	65"-100"	65"-100"
VESA:	VESA 400, 40cm	VESA 400, 40cm	Max 400x900mm	Max 400x1200mm
EAN:	735007373 8403	735007373 8410	735010521 9474	735010521 9481
Max load:	30kg (Per screen)	30kg (Per screen)	50kg	100kg
Bracket type:	Fixed	Fixed	Fixed	Fixed
Landscape / portrait:	Landscape	Landscape	Portrait	Portrait
Pillar length:	180 cm	270 cm	180 cm	270 cm
Colour (VESA arms):	Black	Black	Black	Black
Colour (Horizontal rail):	Black (Silver optional)	Black (Silver optional)	Black (Silver optional)	Black (Silver optional)
Colour (Pillar):	Black	Black	Black	Black
Warranty:	5 years	5 years	5 years	5 years

Video Wall Stand 1X2



Video Wall Stand 1X3



Video Wall Stand MBF2x2Ux3
270 Micro Adjustable



Video Wall Stand MBF3x2Ux5
270 Micro Adjustable



Video Wall Stand MBF4x2Ux7
270 Micro Adjustable

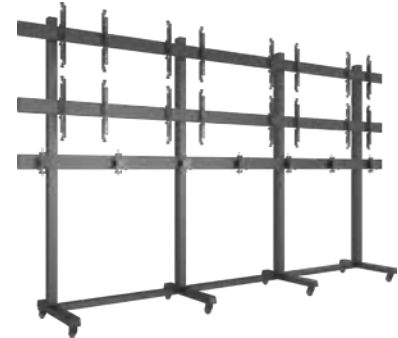

Model:	Video Wall Stand 1X2	Video Wall Stand 1X3	Video Wall Stand MBF2x2Ux3 270 Micro Adjustable	Video Wall Stand MBF3x2Ux5 270 Micro Adjustable	Video Wall Stand MBF4x2Ux7 270 Micro Adjustable
Screen size:	46"-75"	46"-75"	17"-32", 43"-65"	17"-32", 43"-65"	17"-32", 43"-65"
VESA:	1000x400mm	1000x400mm	75 /100mm, VESA 400, 40cm	75 /100mm, VESA 400, 40cm	75 /100mm, VESA 400, 40cm
EAN:	735010521 6961	735010521 6954	735010521 6909	735010521 6916	735010521 6923
Max load:	50kg (Per screen)	50kg (Per screen)	10 / 30kg (Per screen)	10 / 30kg (Per screen)	10 / 30kg (Per screen)
Bracket type:	Micro Adjustable	Micro Adjustable	Tilt, Micro Adjustable	Tilt, Micro Adjustable	Tilt, Micro Adjustable
Landscape / portrait:	Portrait	Yes	Landscape	Landscape	Landscape
Pillar length:	180 cm	270 cm	270 cm	270 cm	270 cm
Colour (VESA arms):	Black	Black	Black	Black	Black
Colour (Horizontal rail):	Black (Silver optional)	Black (Silver optional)	Black (Silver optional)	Black (Silver optional)	Black (Silver optional)
Colour (Pillar):	Black	Black	Black	Black	Black
Warranty:	5 years	5 years	5 years	5 years	5 years

**M Floorstand Pro
MBFSC1U 180 Fixed 1600X600**



**M Floorstand Pro
MBF1UXL 300 Fixed 1600X900**

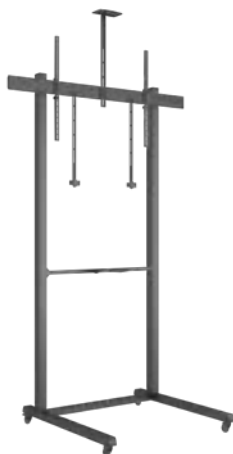

**M Floorstand Pro
MBF1UXL 300 Fixed 1600X900**

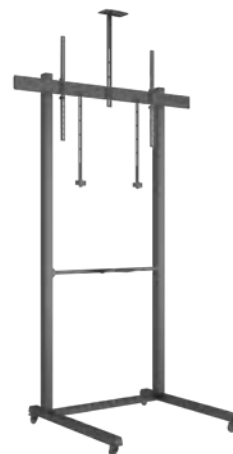

**M Collaboration Floorstand
Side by Side 65"**



**MBFSC1U 180 Fixed
1600X900**



**MBFSC1U 270 Fixed
1600X900**



Model name:	M Floorstand Pro MBFSC1U 180 Fixed 1600X600	M Floorstand Pro MBFSC1U 270 Fixed 1600X600	M Floorstand Pro MBF1UXL 300 Fixed 1600X900	M Collaboration Floor- stand Side by Side 65"	MBFSC1U 180 Fixed 1600X900	MBFSC1U 270 Fixed 1600X900
Screen size:	98"-110"	98"-110"	98"-110"	40"-65"	85"-120"	85"-120"
VESA:	Max 1600x600mm	Max 1600x900mm	Max 1600x900mm	VESA 400, 40cm	Max 1600x900mm	Max 1600x900mm
EAN:	735002273 8454	735010521 7111	735002273 8461	735010521 6183	734023481 2806	734023481 2813
Max load:	90kg	90kg	90kg	30kg (Per screen)	90kg	90kg
Bracket type:	Fixed	Fixed	Fixed	Fixed	Fixed	Fixed
Landscape / portrait:	Landscape	Landscape	Landscape	Landscape	Landscape	Landscape
Pillar length:	180 cm	270 cm	300 cm	180 cm	180 cm	270 cm
Colour (VESA arms):	Black	Black	Black	Black	Black	Black
Colour (Horizontal rail):	Black (Silver optional)	Black (Silver optional)	Black (Silver optional)	Black (Silver optional)	Black (Silver optional)	Black (Silver optional)
Colour (Pillar):	Black	Black	Black	Black	Black	Black
Warranty:	5 years	5 years	5 years	5 years	5 years	5 years
Accessories:	Cover plates	Cover plates	Cover plates	Cover plates	Cover plates	Cover plates

M Collaboration Floorstand Side by Side 75"



M Collaboration Floorstand Side by Side 90"



M Floorstand Pro MBF1UXL 300 Fixed 1600X900



M Collaboration Floorstand Side by Side 65"



Model:	M Collaboration Floorstand Side by Side 75"	M Collaboration Floorstand Side by Side 90"	M Floorstand Pro MBF1UXL 300 Fixed 1600X900	M Collaboration Floorstand Side by Side 65"
Screen size:	65"-75"	85"-90"	98"-110"	40"-65"
VESA:	Max 600x400mm	Max 800x400mm	Max 1600x900mm	VESA 400, 40cm
EAN:	735010521 6190	735010521 6206	735002273 8461	735010521 6183
Max load:	50kg (Per screen)	50kg (Per screen)	90kg	30kg (Per screen)
Bracket type:	Fixed	Fixed	Fixed	Fixed
Landscape / portrait:	Landscape	Landscape	Landscape	Landscape
Pillar length:	180 cm	270 cm	300 cm	180 cm
Colour (VESA arms):	Black	Black	Black	Black
Colour (Horizontal rail):	Black (Silver optional)	Black (Silver optional)	Black (Silver optional)	Black (Silver optional)
Colour (Pillar):	Black	Black	Black	Black
Warranty:	5 years	5 years	5 years	5 years

M Collaboration Floorstand Side by Side 75"



M Collaboration Floorstand Side by Side 90"



M Collaboration Floorstand Side by Side 75" VESA 600



M Collaboration Floorstand Side by Side 90" VESA 800



M Collaboration Floorstand Side by Side 100" VESA 900



Model:	M Collaboration Floorstand Side by Side 75"	M Collaboration Floorstand Side by Side 90"	M Collaboration Floorstand Side by Side 75" VESA 600	M Collaboration Floorstand Side by Side 90" VESA 800	M Collaboration Floorstand Side by Side 100" VESA 900
Screen size:	65"-75"	85"-90"	75"	90"	100"
VESA:	Max 600x400mm	Max 800x400mm	Max 800x600mm	Max 1000x800mm	Max 1300x900mm
EAN:	735010521 6190	735010521 6206	734023481 0765	734023481 0772	734023481 0789
Max load:	50kg (Per screen)	50kg (Per screen)	50kg (Per screen)	50kg (Per screen)	50kg (Per screen)
Bracket type:	Fixed	Fixed	Fixed	Fixed	Fixed
Landscape / portrait:	Landscape	Landscape	Landscape	Landscape	Landscape
Pillar length:	180 cm	270 cm	300 cm	180 cm	180 cm
Colour (VESA arms):	Black	Black	Black	Black	Black
Colour (Horizontal rail):	Black (Silver optional)	Black (Silver optional)	Black (Silver optional)	Black (Silver optional)	Black (Silver optional)
Colour (Pillar):	Black	Black	Black	Black	Black
Warranty:	5 years	5 years	5 years	5 years	5 years

TailorMade

by Multibrackets



Curious how others succeed with their digital signage projects?



Multibrackets plays a key role in successful installations worldwide, working closely with our distribution partners to deliver reliable, tailor-made solutions for every type of project.

From concept to completion, we support you with Scandinavian design, in many cases EU-manufactured quality, and expert guidance, whether you need a standard mount or a fully customized solution.

Contact our Tailor-Made team at:
tailormade@multibrackets.com



Pro Series

Wire combinations

Make a bold design statement with the Pro Series wire-based mounting system. This elegant solution allows you to suspend displays on wires while utilizing standard Pro Series components for maximum

compatibility. Suitable for both single-screen and back-to-back installations, these wire combinations create a striking, minimalistic look that transforms any retail environment. Designed to

combine style with functionality, they offer easy setup and deliver a major visual impact with a clean, modern aesthetic. Up to 600cm height, single or back to back.

Wire 3000



Wire 6000



Up to 600cm

Wire 3000 B2B



Wire 6000 B2B



Back to back

	Wire 3000	Wire 6000	Wire 3000 B2B	Wire 6000 B2B
Model:	Wire 3000	Wire 6000	Wire 3000 B2B	Wire 6000 B2B
Screen size:	40" - 65"	40" - 65"	40" - 65"	40" - 65"
VESA:	VESA 600, 60 cm	VESA 600, 60 cm	VESA 600, 60 cm	VESA 600, 60 cm
EAN:	735007373 6959	735007373 6966	735007373 7055	735007373 7062
Max load:	30 kg	30 kg	30kg (Per screen)	30kg (Per screen)
Bracket type:	Fixed	Fixed	Fixed	Fixed
Landscape / portrait:	Portrait	Portrait	Portrait	Portrait
Wire length:	300 cm	600 cm	300 cm	600 cm
Colour (VESA arms):	Black	Black	Black	Black
Colour (Wire):	Chrome	Chrome	Chrome	Chrome
Warranty:	5 years	5 years	5 years	5 years

Wire Ceiling 3000 Back to Back



Wire Ceiling 6000 Back to Back



Ceiling Wire Kit 3000



Ceiling Wire Kit 6000



	Wire Ceiling 3000 Back to Back	Wire Ceiling 6000 Back to Back	Ceiling Wire Kit 3000	Ceiling Wire Kit 6000
Model:	Wire Ceiling 3000 Back to Back	Wire Ceiling 6000 Back to Back	Ceiling Wire Kit 3000	Ceiling Wire Kit 6000
Screen size:	32" - 65"	32" - 65"	--	--
VESA:	Max 600x400mm	Max 600x400mm	--	--
EAN:	735002273 9932	735002273 9949	735002273 8713	735002273 8720
Max load:	30kg (Per screen)	30kg (Per screen)	50kg (Per screen)	50kg (Per screen)
Bracket type:	Fixed	Fixed	735002273 8713	735002273 8713
Landscape / portrait:	Portrait	Portrait	735002273 8713	735002273 8713
Wire length:	300cm	600 cm	300 cm	600 cm
Colour:	Black	Black	Chrome	Chrome
Warranty:	5 years	5 years	5 years	5 years

Wire MBC1U VESA 75/100



Wire MBC1UX2 VESA 75/100



Wire MBC2U VESA 75/100

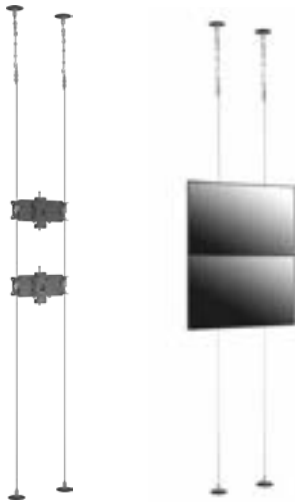

Wire MBC3U VESA 75/100



Model:	Wire MBC1U VESA 75/100	Wire MBC1UX2 VESA 75/100	Wire MBC2U VESA 75/100	Wire MBC3U VESA 75/100
Screen size:	27"-32"	27"-32"	27"-32"	27"-32"
VESA:	50x50/75x75/100x100	50x50/75x75/100x100	50x50/75x75/100x100	50x50/75x75/100x100
EAN:	73402348 1274	73402348 1281	73402348 1298	73402348 1304
Max load:	10kg	10kg (Per screen)	10kg (Per screen)	10kg (Per screen)
Bracket type:	Fixed	Fixed	Fixed	Fixed
Landscape / portrait:	Yes	Yes	Yes	Yes
Wire length:	300cm	300 cm	300 cm	300 cm
Colour:	Black	Black	Chrome	Chrome
Warranty:	5 years	5 years	5 years	5 years



Works well with:



SAMSUNG

Pro Series Kiosks for monitors

The Multibrackets Pro Series M Floorstand is a compact and durable mounting solution for LED displays. Built from steel and designed at 1 m height, it supports a single screen from 7" to 30", with VESA compatibility of 75x75 and 100x100.

As part of the professional Pro Series A/V line, this floorstand was created with installers in mind, modular, easy to configure, quick to install, and simple to maintain. Like all Pro Series solutions, it offers the versatility and flexibility professionals demand.



M Pro Series Single Pole Floorbase



M Pro Series Single Pole Floorbase B2B



Kiosk Black 15"-32"

Kiosk White 15"-32"

M Pro Series Kiosk Black 15"-32"

M Pro Series - Kiosk 15-32" 200/300/400

M Kiosk Black with Lockable Tablet Mount 7"-14.6"15-32" 200/300/400



New
Tablet holder

Model name:	M Pro Series Single Pole Floorbase	M Pro Series Single Pole Floorbase B2B	M Pro Series Kiosk Black 15"-32"	M Pro Series - Kiosk 15-32" 200/300/400	M Kiosk Black with Lockable Tablet Mount 7"-14.6"
Screen size:	10"-30"	10"-30"	15"-32"	15"-32"	15"-32"
VESA:	75x75, 100x100cm	75x75, 100x100cm	75x75, 100x100, 200x100	200x200, 300x300, 400x400	Tablet mount 7"-14.6"
EAN:	735010521 0549	735010521 3069	735010521 5179	735010521 5490/5483	735010521 7128
Max load:	10 kg	10 kg/screen	20 kg	20 kg	20 kg
Bracket type:	Tilt	Tilt	Fixed	Fixed	Fixed
Floormount:	Yes	Yes	Yes	Yes	-
Floorstand:	Yes (floorbase included)	Yes (floorbase included)	Yes (floorbase included)	Yes (floorbase included)	-
Landscape/portrait:	Yes	Yes	Yes	Yes	Yes
Pole height (cm):	1000mm	1000mm	450x300x1045mm	450x300x1045mm	450x300x1045mm
Colour:	Black	Black	Black	White / Black	Black
Warranty:	5 years	5 years	5 years	5 years	5 years

M Pro Series Single Pole Floorbase 2 Black



M Pro Series Single Pole Floorbase 2 White



M Pro Series Single Pole Floorbase Tablet Black



M Pro Series Single Pole Floorbase Tablet White



	M Pro Series Single Pole Floorbase 2 Black	M Pro Series Single Pole Floorbase 2 White	M Pro Series Single Pole Floorbase Tablet Black	M Pro Series Single Pole Floorbase Tablet White
Model:	M Pro Series Single Pole Floorbase 2 Black	M Pro Series Single Pole Floorbase 2 White	M Pro Series Single Pole Floorbase Tablet Black	M Pro Series Single Pole Floorbase Tablet White
EAN:	734023481 2011	734023481 2028	735002273 8379	
Color:	Black	White	Black	White
VESA:	75x75, 100x100, 200x100, 200x200	75x75, 100x100, 200x100, 200x200	75x75, 100x100 mm	75x75, 100x100 mm
Material:	Steel	Steel	Steel	Steel
Surface Finish:	Powder coating	Powder coating	Powder coating	Powder coating
Max Load:	10 kg	10 kg	10 kg	10 kg
Tilt:	90°	90°	90°	90°
Swivel:	360°	360°	360°	360°
Installation:	PRO SERIES	PRO SERIES	PRO SERIES	PRO SERIES
Warranty:	5 years	5 years	5 years	5 years

M Pro Series - Kiosk Black 32"-65"



M Pro Series - Kiosk White 32"-65"



M Pro Series - Kiosk Black 65"-86"



Up to 86"

M Pro Series - Kiosk White 65"-86"



	M Pro Series - Kiosk Black 32"-65"	M Pro Series - Kiosk White 32"-65"	M Pro Series - Kiosk Black 65"-86"	M Pro Series - Kiosk White 65"-86"
Model:	M Pro Series - Kiosk Black 32"-65"	M Pro Series - Kiosk White 32"-65"	M Pro Series - Kiosk Black 65"-86"	M Pro Series - Kiosk White 65"-86"
EAN:	735010521 7357	7350105217364	734023481 0529	734023481 0536
Color:	Black	White	Black	White
VESA:	Max 700x400	Max 700x400	Max 900x600	Max 900x600
Screen size:	32"-65"	32"-65"	65"-86"	65"-86"
Tilt angle:	-	-	45°	45°
Material:	Steel/ Powder coating	Steel/ Powder coating	Steel/ Powder coating	Steel/ Powder coating
Max load:	50kgs	50kgs	50kgs	50kgs
Warranty:	5 years	5 years	5 years	5 years

Single Pole Floorbase QBR13 Black



Single Pole Floorbase Round VESA 50/75/100/200 B2B



Single Pole Floorbase Round VESA 50/75/100/200

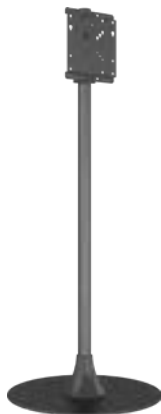

Single Pole Floorbase Round VESA 50/75/100/200 B2B



	Single Pole Floorbase QBR13 Black	Single Pole Floorbase QBR13 White	Single Pole Floorbase Round VESA 50/75/100/200	Single Pole Floorbase Round VESA 50/75/100/200 B2B
Model:	Single Pole Floorbase QBR13 Black	Single Pole Floorbase QBR13 White	Single Pole Floorbase Round VESA 50/75/100/200	Single Pole Floorbase Round VESA 50/75/100/200 B2B
Screen size:	QBR13	QBR13	32" - 55"	32" - 55"
VESA:	75x75, 100x100mm	75x75, 100x100mm	50x50, 75x75, 100x100, 200x200	50x50, 75x75, 100x100, 200x200
EAN:	735010521 9719	735010521 9702	735010521 9085	735010521 9108
Max load:	10 kg	10 kg	45kg	30kg (Per screen)
Bracket type:	Tilt	Tilt	Fixed	Fixed
Landscape/portrait:	Yes	Yes	Yes	Yes
Wire length:	100 cm	100 cm	150 cm	150 cm
Colour:	Black	White	Black	Black
Accessories:	5 years	5 years	5 years	5 years

Floormount Pole B2B 50/75/100/200



Single Pole Floorbase Round VESA 400

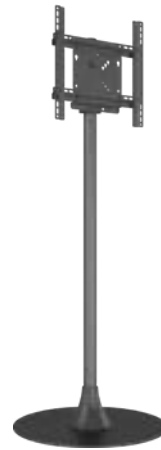

Single Pole Floorbase Round VESA 400 B2B

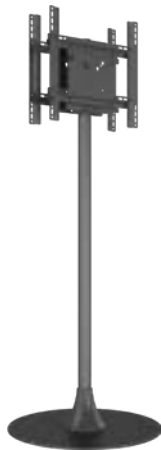

Single Pole Floorbase Round VESA 400 B2B



Model:	Floormount Pole B2B 50/75/100/200	Single Pole Floorbase Round VESA 400	Single Pole Floorbase Round VESA 400 B2B	Floorbase Pole B2B VESA 400
Screen size:	32"-65"	32" - 65"	32" - 65"	32" - 65"
VESA:	50x50, 75x75, 100x100, 200x200mm	200x200, 300x300, 400x400	200x200, 300x300, 400x400	200x200, 300x300, 400x400mm
EAN:	735010521 9917	735007373 8403	735010521 9115	734023481 1953
Max load:	45kg	45kg	30kg (Per screen)	45 kg per screen
Bracket type:	Fixed	Fixed	Fixed	Fixed
Landscape/portrait:	Yes	Yes	Yes	Yes
Wire length:	150 cm	150 cm	150 cm	160 cm
Colour:	Black	Black	Black	Black
Accessories:	5 years	5 years	5 years	5 years



A selection of our Enclosures & Totems

Create a sleek, minimalistic look with Multibrackets® enclosures, designed for both portrait and landscape mounting. Among the most versatile on the market, they are available in multiple screen sizes and colors, and support a wide range of professional signage displays.

With smart thermal management, these enclosures ensure reliable performance across

different display brands while maintaining a modern, professional aesthetic. The depth-adjustable exterior frame allows flexibility in display choice, while reversible hinges eliminate installation and service obstructions.

Engineered for serviceability, the design offers unparalleled access for maintenance, integrated passive cooling

with optional active thermal management, and tamperproof security hardware to protect your investment.

These clean-styled black Pro Series enclosures bring new levels of flexibility to the signage enclosure market. Combined with their ingenious design, they can be adapted for multiple mounting options, including wire suspension, floor-

to-ceiling, floorstand, or ceiling mounting, either immediately or as your needs evolve.



M Pro Series Enclosures



Pro Series 10"-24" enclosures

**Simplify small size signage installations
with a thin and easy-to-install enclosure**

Bring elegance and functionality together with Multibrackets' new indoor enclosures, designed to support the latest small-format LED displays.

With their slim profile and ingenious design, these enclosures are easy to install, simple to maintain, and versatile enough for a wide range of applications.

M Pro Series Enclosure ELO & Philips 10"



PHILIPS

elo

M Pro Series Enclosure Cisco Touch 10" White



CISCO

M Pro Series Enclosure QB13C & QB13C-T

NEW

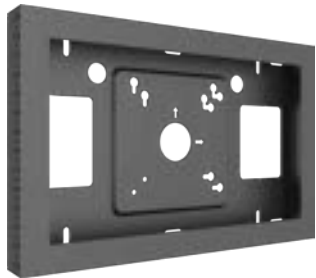

- Black
- White

SAMSUNG

M Pro Series Enclosure LG22SM3G



- Black
- White

LG

M Pro Series Enclosure QB24R & QB24R-T



- Black
- White

SAMSUNG

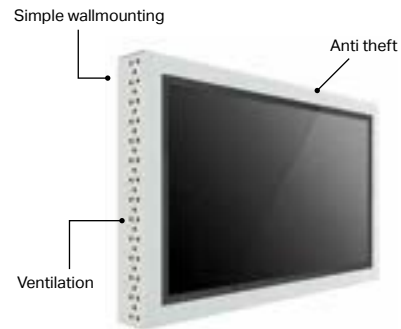

Model:	M Pro Series Enclosure ELO & Philips 10"	M Pro Series Enclosure Cisco Touch 10"	M Pro Series Enclosure QB13C & QB13C-T	M Pro Series Enclosure LG22SM3G	M Pro Series Enclosure QB24R & QB24R-T
EAN:	735007373 9400	735010521 0488	Black: 735007373 8519 White: 735007373 8908	Black: 735010521 1041 White: 735010521 1058	Black: 735010521 1386 White: 735010521 1393
VESA:	75x75 mm	100x100mm	100x100mm	100x100 mm	100x100 mm
Installation:	ELO 10", Philips 10" 10BDL4551T 10BDL3351T and 10BDL5051T	Cisco CTS-CTRL-DV10	Samsung QB13C & QB13C-T	LG 22" 22SM3G	Samsung QB24R or QB24R-T
Weight:	2.0 kg	0.9kg	2kg	3,2 kg	3,5 kg
Max Load:	5 kg	5 kg	10 kg	10 kg	10 kg
Measurements :	320 x 242 x 52 mm	301 x 232 x 50 mm	392 x 262 x 25 mm	590 x 380 x 65 mm	615 x 385 x 48 mm
Material:	Steel	Steel	Steel	Steel	Steel
Surface Finish:	Powder coating	Powder coating	Powder coating	Powder coating	Powder coating
Colour:	Black	White	Black / White	Black / White	Black / White
Warranty:	5 years	5 years	5 years	5 years	5 years



Enclosure 32" Ceiling Small Black



Enclosure 32" Ceiling Small White



Enclosure 37" Ceiling Small Black



Enclosure 37" Ceiling Small White



Enclosure 37" Back to Back Mount Black



Enclosure 37" Ceiling Small White



Model:	Enclosure 32" Ceiling Small	Enclosure 32" Ceiling Small	Enclosure 37" Ceiling Small	Enclosure 37" Ceiling Small	Enclosure 37" Back to Back Mount	Enclosure 37" Ceiling Small
Screen size:	32"	32"	37"	37"	37"	37"
VESA:	200x200, 300x300mm	200x200, 300x300mm	200x200, 300x300mm	200x200, 300x300mm	Up to 400x200mm	Up to 400x200mm
EAN:	735010521 5018	735010521 5025	735010521 5209	735010521 5216	735010521 1508	735010521 1515
Max load:	30kg	30kg	30kg	30kg	25 kg	25 kg per screen
Landscape/portrait:	Yes	Yes	Yes	Yes	Yes	Yes
Pole length:	80cm up to 150cm	80cm up to 150cm	80cm up to 150cm	80cm up to 150cm	80cm up to 150cm	80cm up to 150cm
Colour:	Black	White	Black	White	Black	White
Accessories:	Yes (optional)	Yes (optional)	Yes (optional)	Yes (optional)	Yes (optional)	Yes (optional)

Enclosure 43" Ceiling Small Black



Enclosure 43" Ceiling Small White



Enclosure 50" Ceiling Medium Black



Enclosure 50" Ceiling Medium White



Enclosure 55" Ceiling Medium Black



Enclosure 55" High Brightness Ceiling Medium White



Model:	Enclosure 43" Ceiling Small Black	Enclosure 43" Ceiling Small White	Enclosure 50" Ceiling Medium Black	Enclosure 50" Ceiling Medium White	Enclosure 55" Ceiling Medium Black	Enclosure 55" High Brightness Ceiling Medium White
Screen size:	43"	43"	50"	50"	55"	55"
VESA:	200x200, 300x300mm	200x200, 300x300mm	200x200, 300x300mm	200x200, 300x300mm	200x200 up to 600x400mm	200x200 up to 600x400mm
EAN:	735010521 5032	735010521 5049	735010521 3854	735010521 3861	735010521 3311	735010521 9900
Max load:	30 kg	30 kg	30 kg	30 kg	40 kg	80 kg
Landscape/portrait:	Yes	Yes	Yes	Yes	Yes	Yes
Pole length:	80cm up to 150cm	80cm up to 150cm	80cm up to 150cm	80cm up to 150cm	80cm up to 150cm	80cm up to 150cm
Colour:	Black	White	Black	White	Black	Black
Accessories:	Yes (optional)	Yes (optional)	Yes (optional)	Yes (optional)	Yes (optional)	Yes (optional)

Enclosure 65" Ceiling Medium



Enclosure 75" Ceiling Large



Enclosure 85" Ceiling Large



Enclosure Ceiling Mount B2B 75" Large Black



Enclosure 50" Ceiling Medium B2B Black



Enclosure Ceiling Mount B2B 55" Medium Black



	Enclosure 65" Ceiling Medium	Enclosure 75" Ceiling Large Black/White	Enclosure 85" Ceiling Large	Enclosure Ceiling Mount B2B 75" Large Black	Enclosure 50" Ceilingmount Medium B2B Black	Enclosure Ceiling Mount B2B 55" Medium Black
Model:	Enclosure 65" Ceiling Medium	Enclosure 75" Ceiling Large Black/White	Enclosure 85" Ceiling Large	Enclosure Ceiling Mount B2B 75" Large Black	Enclosure 50" Ceilingmount Medium B2B Black	Enclosure Ceiling Mount B2B 55" Medium Black
Screen size:	65"	75"	85"	75"	50"	55"
VESA:	200x200, 300x300, 400x400, 600x400mm	200x200, 300x300, 400x400, 600x400mm	200x200 up to 800x600mm	200x200 up to 600x400mm	200x200, 300x300, 400x400, 600x400mm	200x200, 300x300, 400x400, 600x400mm
EAN:	735010521 3328	735010521 5810/5827	735002273 9208	734023481 2714	735010521 3939	735010521 6825
Max load:	50 kg	50 kg	80 kg	80 kg	30 kg (Per screen)	30 kg (Per screen)
Landscape/portrait:	Yes	Yes	Yes	Yes	Yes	Yes
Pole length:	80cm up to 150cm	80cm up to 150cm	80cm up to 150cm		80cm up to 150cm	80cm up to 150cm
Colour:	Black	Black / White	Black	Black	Black	Black
Accessories:	Yes (optional)	Yes (optional)	Yes (optional)	Yes (optional)	Yes (optional)	Yes (optional)



Model:	Enclosure 32" Floor to Ceiling Medium Black	Enclosure 43" Floor to Ceiling Medium White
Screen size:	32"	43"
VESA:	200x200	300x300
EAN:	734023481 0680	735002273 7327
Max load:	50kg	50kg
Landscape/portrait:	Yes	Yes
Pole length:	150cm up to 300cm	150cm up to 300cm
Colour:	Black	White
Accessories:	Yes (optional)	Yes (optional)

Enclosure 50" Floor to Ceiling Medium Black



Enclosure 50" Floor to Ceiling Medium White



Enclosure Floor to Ceiling Mount B2B 55" Medium Black



Enclosure Floor to Ceiling Mount B2B 55" Medium White



Enclosure Floor to Ceiling Mount B2B 65" Medium Black



Enclosure Floor to Ceiling Mount B2B 65" Medium White



Model:	Enclosure 50" Floor to Ceiling Medium	Enclosure 50" Floor to Ceiling Medium	Enclosure Floor to Ceiling B2B 55" Medium	Enclosure Floor to Ceiling B2B 55" Medium	Enclosure Floor to Ceiling B2B 65" Medium	Enclosure Floor to Ceiling B2B 65" Medium
Screen size:	50"	50"	55"	55"	65"	65"
VESA:	200x200, 300x300, 400x400, 600x400mm	200x200, 300x300, 400x400, 600x400mm	200x200, 300x300, 400x400, 600x400mm	200x200, 300x300, 400x400, 600x400mm	200x200, 300x300, 400x400, 600x400mm	200x200, 300x300, 400x400, 600x400mm
EAN:	735010521 3892	735010521 3908	735010521 6863	735010521 6870	735002273 3381	735002273 3398
Max load:	50kg	50kg	50kg (Per screen)	50kg (Per screen)	50 kg	50 kg
Landscape/portrait:	Yes	Yes	Yes	Yes	Yes	Yes
Pole length:	150cm up to 300cm	150cm up to 300cm	150cm up to 300cm	150cm up to 300cm	150cm up to 300cm	150cm up to 300cm
Colour:	Black	White	Black	White	Black	White
Accessories:	Yes (optional)	Yes (optional)	Yes (optional)	Yes (optional)	Yes (optional)	Yes (optional)

Enclosure 65" Floor to Ceiling Medium Black



Enclosure 65" Floor to Ceiling Medium White



Enclosure 75" Floor to Ceiling Medium Black



Enclosure 75" Floor to Ceiling Medium White



Enclosure 75" High Brightness Floor to Ceiling Large Black



Enclosure 85" Floor to Ceiling Large White



Model:	Enclosure 65" Floor to Ceiling Medium Black	Enclosure 65" Floor to Ceiling Medium White	Enclosure 75" Floor to Ceiling Medium Black	Enclosure 75" Floor to Ceiling Medium White	Enclosure 75" High Brightness Floor to Ceiling Large Black	Enclosure 85" Floor to Ceiling Large White
Screen size:	65"	65"	75"	75"	75"	85"
VESA:	200x200, 300x300, 400x400, 600x400mm	200x200, 300x300, 400x400, 600x400mm	200x200, 300x300, 400x400, 600x400mm	200x200, 300x300, 400x400, 600x400mm	200x200 - 600x800mm	200x200 - 600x800mm
EAN:	735010521 5711	735010521 5728	735010521 5735	735010521 5742	735010521 7548	735002273 9253
Max load:	50 kg	50 kg	75 kg	75 kg	75 kg	75 kg
Landscape/portrait:	Yes	Yes	Yes	Yes	Yes	Yes
Pole length:	150cm up to 300cm	150cm up to 300cm	150cm up to 300cm	150cm up to 300cm	150cm up to 300cm	150cm up to 300cm
Colour:	Black	White	Black	White	White	White
Accessories:	Yes (optional)	Yes (optional)	Yes (optional)	Yes (optional)	Yes (optional)	Yes (optional)

Enclosure 43" Wire B2B Black



Enclosure 50" Wire B2B Black



Enclosure 55" High Brightness Wire Black



Enclosure 55" High Brightness Wire Black



Model:	Enclosure 43" Wire Medium B2B Black	Enclosure 50" Wire Medium B2B Black	Enclosure 55" Wire F2C Medium Black	Enclosure 55" Wire F2C Medium White
Screen size:	43"	50"	55"	55"
VESA:	200x200, 300x300, 400x400, 600x400mm	200x200, 300x300, 400x400, 600x400mm	200x200, 300x300, 400x400, 600x400mm	200x200, 300x300, 400x400, 600x400mm
EAN:	735010521 6374	735010521 3946	735010521 7470	735010521 7463
Max load:	30kg (Per screen)	30kg (Per screen)	30kg	50kg
Landscape/portrait:	Yes	Yes	Yes	Yes
Wire length:	150cm	150cm	150cm up to 300cm	150cm up to 300cm
Colour:	Black	Black	Black	Black
Accessories:	Yes (optional)	Yes (optional)	Yes (optional)	Yes (optional)

Floormount Indoor Totem 55"



Enclosure Totem 55" Wheelbase Indoor



Enclosure Totem 55" Floorbase Indoor



Enclosure Totem Covered 55" Floormount



Model:	Floormount Indoor Totem 55"	Enclosure Totem 55" Wheelbase Indoor	Enclosure Totem 55" Floorbase Indoor	Enclosure Totem Covered 55" Floormount
Screen size:	55"	55"	55"	55"
VESA:	200x200, 300x300, 400x400, 400x500mm	200x200, 300x300, 400x400, 400x500mm	200x200, 300x300, 400x400, 400x500mm	200x200, 300x300, 400x400, 400x500mm
EAN:	735010521 4776	735010521 4837	735010521 4820	735010521 5308
Max load:	35 kg	35 kg	35 kg	35 kg
Landscape/portrait:	Portrait	Portrait	Portrait	Portrait
Colour:	Black	Black	Black	Black
Accessories:	Yes (optional)	Yes (optional)	Yes (optional)	Yes (optional)

Enclosure Totem Covered 55" Wheelbase



Enclosure Totem Covered 55" Floorbase



Enclosure Totem 85" Floorbase Black



Enclosure Totem 86" Floorbase Black



Enclosure Totem 98" Floorbase Black



	Enclosure Totem Covered 55" Wheelbase	Enclosure Totem Covered 55" Floorbase	Enclosure Totem 85" Floorbase Black	Enclosure Totem 86" Floorbase Black	Enclosure Totem 98" Floorbase Black
Model:	Enclosure Totem Covered 55" Wheelbase	Enclosure Totem Covered 55" Floorbase	Enclosure Totem 85" Floorbase Black	Enclosure Totem 86" Floorbase Black	Enclosure Totem 98" Floorbase Black
Screen size:	55"	55"	85"	86"	98"
VESA:	200x200, 300x300, 400x400, 400x500mm	200x200, 300x300, 400x400, 400x500mm	Up to 600x800mm	Up to 600x800mm	Up to 1000x800mm
EAN:	735010521 5315	735010521 5292	735010521 9641	734023481 0093	734023481 0109
Max load:	35 kg	35 kg	35 kg	35 kg	35 kg
Landscape/portrait:	Portrait	Portrait	Portrait	Portrait	Portrait
Colour:	Black	Black	Black	Black	Black
Accessories:	Yes (optional)	Yes (optional)	Yes (optional)	Yes (optional)	Yes (optional)

Enclosure Totem 65" Floorbase Indoor

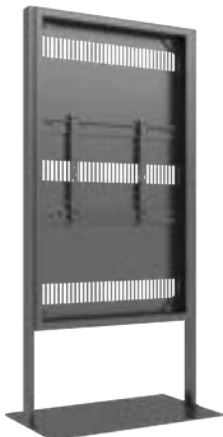

Enclosure Totem 65" Back to Back Floorbase Indoor



Enclosure B2B Totem 43" Floormount with Base



Enclosure B2B Totem 55" Floormount with Base



	Enclosure Totem 65" Floorbase Indoor	Enclosure Totem 65" Back to Back Floorbase Indoor	Enclosure B2B Totem 43" Floormount with Base	Enclosure B2B Totem 55" Floormount with Base
Model:	Enclosure Totem 65" Floorbase Indoor	Enclosure Totem 65" Back to Back Floorbase Indoor	Enclosure B2B Totem 43" Floormount with Base	Enclosure B2B Totem 55" Floormount with Base
Screen size:	65"	65"	43"	55"
VESA:	200x200, 300x300, 400x400, 400x500mm	200x200, 300x300, 400x400, 400x500mm	200x200, 300x300, 400x400, 400x500mm	200x200, 300x300, 400x400, 400x500mm
EAN:	735010521 6930	735010521 6947	735010521 5438	735010521 5445
Max load:	35kg	35kg	35kg	35kg
Landscape/portrait:	Portrait	Portrait	Portrait	Portrait
Colour:	Black	Black	Black	Black
Accessories:	Yes (optional)	Yes (optional)	Yes (optional)	Yes (optional)



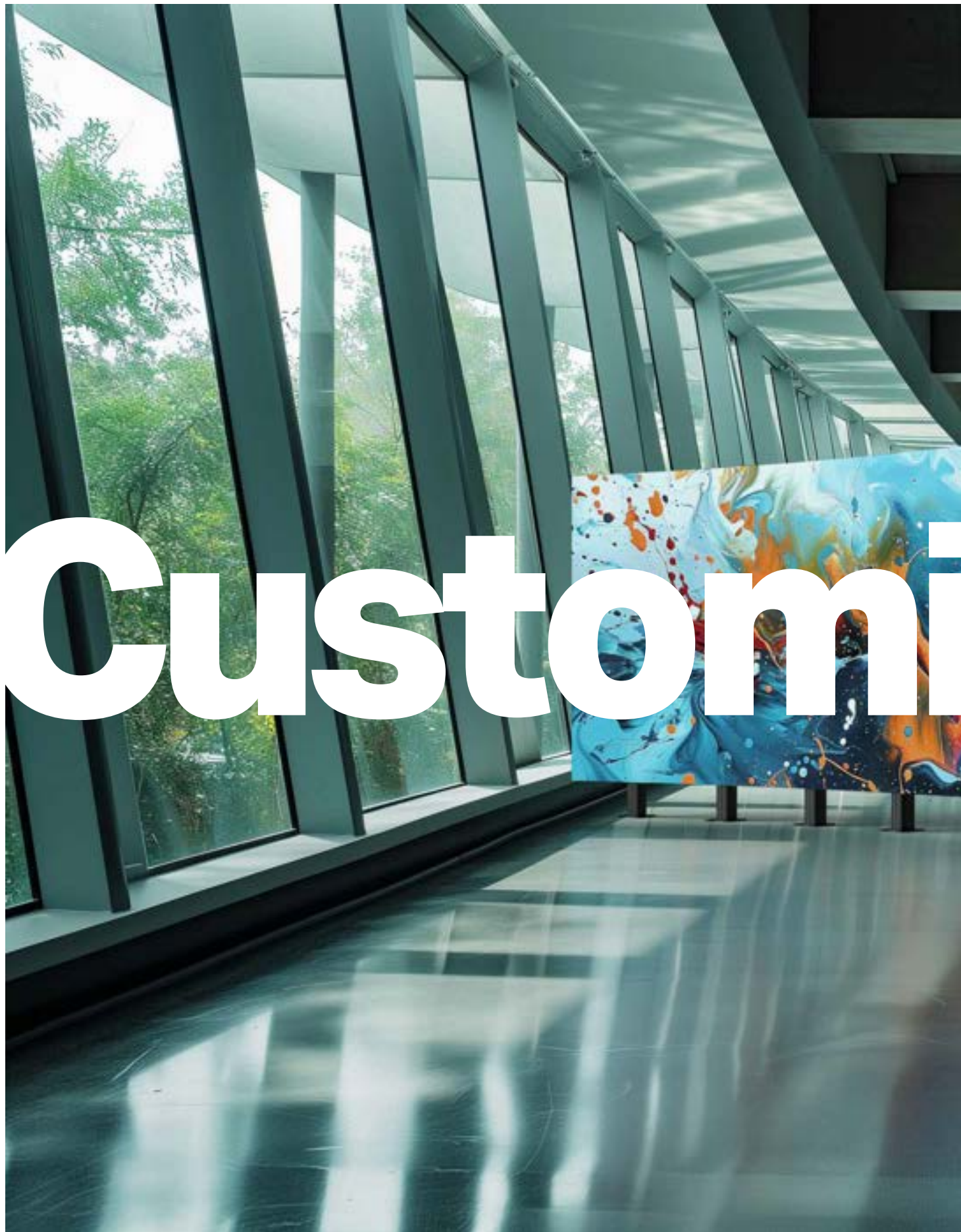

Customi



ized LED

Customized Sidecovers



Pro Series LED solutions

Supporting all major brands and mounting solutions

Inspired by AV installers

Multibrackets is committed to meeting the evolving needs of the AV industry. In collaboration with installers and display manufacturers, we have developed a complete line of Pro Series LED mounting solutions, combining innovative features, ease of installation, and simplified maintenance, all at a competitive total cost of ownership.

With decades of audio-visual experience, Multibrackets has become one of the industry's most forward-thinking mount manufacturers. Our Pro Series LED solutions emphasize high-quality design, aesthetic results, and cost efficiency. Behind every solution is a dedicated team of LED professionals, from mechanical engineers to project managers,

working closely with partners and installers to ensure flawless execution and long-term success.

Highlights:

- . Simple installation
- . Cable management
- . Lightweight aluminum
- . Seamless result

Customized Sidecovers:

- . Superslim design
- . Millimeter precision to LED panels
- . Easy afterservice access

Exclusive LED design for:



SAMSUNG



Image courtesy of Samsung Corp

M Pro Series LED – Customized for Samsung

IER / IEA / IFR Series / The Wall

Samsung, one of the world's leading display manufacturers, delivers LED signage solutions designed for professional business environments.

With Multibrackets Pro Series LED mounts customized for Samsung, you can unlock the full potential of these displays — ensuring perfect fit, seamless integration, and reliable performance. Together, they provide stunning image quality and a professional installation that captures attention in any setting.

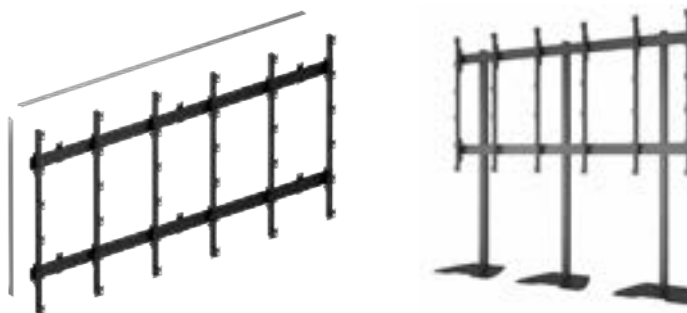

Customized Sidecovers



M Pro Series LED:	SAMSUNG - IER	SAMSUNG - IEA	SAMSUNG - IFR
Non Vesa Fixing:	Tailor made	Tailor made	Tailor made
EAN:	TBD	TBD	TBD
Max Load:	Tailor made for SAMSUNG IER/IEA/IFR Series	Tailor made for SAMSUNG IER/IEA/IFR Series	Tailor made for SAMSUNG IER/IEA/IFR Series
Bracket type:	Fixed	Fixed	Fixed
Landscape / Portrait:	Yes	Yes	Yes
Quick install:	Yes	Yes	Yes
Warranty:	5 years	5 years	5 years



Image courtesy of LG Corp

M Pro Series LED - Customized for LG

LAB / LSC / Magnit and more series

LG Electronics has long been at the forefront of display innovation, and its LED technology is no exception. With a wide range of LED products, LG offers solutions to meet virtually any requirement.

Multibrackets Pro Series LED mounts customized for LG ensure perfect alignment, seamless integration, and professional results — making the most of LG’s advanced LED displays in any environment.

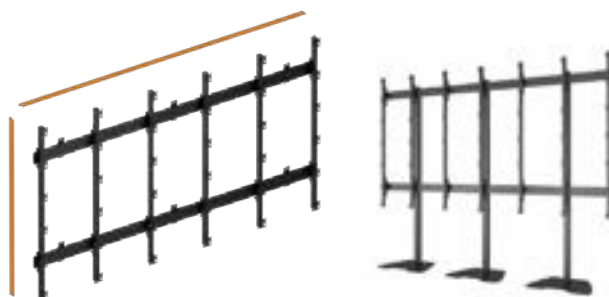

Customized Sidecovers



M Pro Series LED:	LG - LAS	LG - LAE	LG - LAE-Q	LG - LAC
Non Vesa Fixing:	Tailor made	Tailor made	Tailor made	Tailor made
EAN:	TBD	TBD	TBD	TBD
Max Load:	Tailor made for SAMSUNG IER/IEA/IFR Series	Tailor made for SAMSUNG IER/IEA/IFR Series	Tailor made for SAMSUNG IER/IEA/IFR Series	Tailor made for SAMSUNG IER/IEA/IFR Series
Bracket type:	Fixed	Fixed	Fixed	Fixed
Landscape / Portrait:	Yes	Yes	Yes	Yes
Quick install:	Yes	Yes	Yes	Yes
Warranty:	5 years	5 years	5 years	5 years

Multibrackets Sports Arena

Create Next-Level Fan Experiences

Today's fans expect more than just the game — they want immersive, next-level experiences. Modern arenas can deliver this through advanced display solutions that turn venues into dynamic entertainment spaces.

Save Time & Cost - Ready-to-Install Mounting

Multibrackets mounting systems are pre-assembled and prepared for fast, hassle-free installation. For LED projects, every detail is handled in production; for LFDs, the Pro Series ensures universal compatibility and easy re-use across future projects.

Maximize the Arena Experience

With the right mounting, you can boost fan engagement and deliver powerful messages across the entire venue. Our expertise and partnerships guarantee successful LED and LFD installations that enhance the fan experience and open new revenue opportunities.

Multibrackets - combining efficiency, reliability, and impact to transform every sports facility into a next-level arena.



LED walls



Menuboard



Totem Pro Series

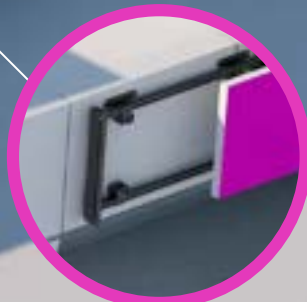
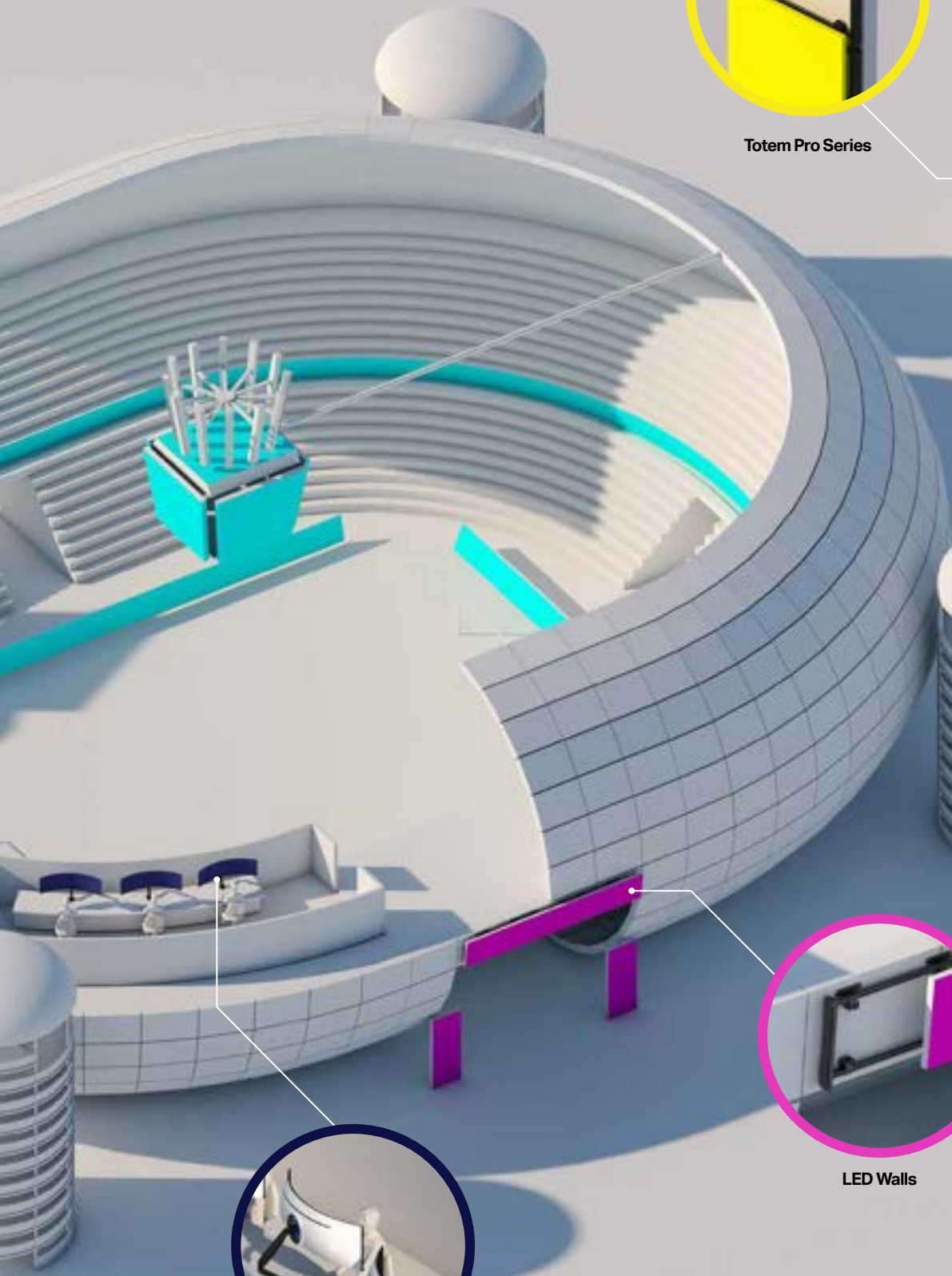

LED Walls



Odyssey + Press room



SHARP / NEC



Image courtesy of SHARP-NEC

M Pro Series LED Customized for SHARP / NEC

E / FE / FA Series

Sharp/NEC's impressive line of direct-view indoor LED displays delivers crystal-clear images and a seamless, bezel-free viewing experience. With vivid brightness and superb clarity from any distance or angle, these displays ensure your message makes maximum impact.

Multibrackets Pro Series LED mounts customized for Sharp/NEC guarantee perfect alignment, structural stability, and a professional finish, unlocking the full potential of these premium LED solutions.

Customized Sidecovers

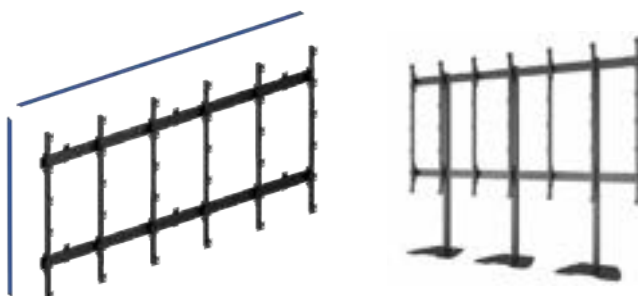

M Pro Series LED:	SHARP/NEC - E	SHARP/NEC - FE	SHARP/NEC - FA
Non Vesa Fixing:	Tailor made	Tailor made	Tailor made
EAN:	TBD	TBD	TBD
Max Load:	Tailor made for SHARP / NEC	Tailor made for SHARP / NEC	Tailor made for SHARP / NEC
Bracket type:	Fixed	Fixed	Fixed
Landscape / Portrait:	Yes	Yes	Yes
Quick install:	Yes	Yes	Yes
Warranty:	5 years	5 years	5 years

PHILIPS



Image courtesy of PHILIPS

M Pro Series LED Customized for PHILIPS

5000/6000/7000/8000/9000 Series

Philips direct-view LED displays offer limitless creative freedom, combine multiple displays to form custom shapes of virtually any size.

With Multibrackets Pro Series LED mounts customized for Philips, you gain seamless integration, structural reliability, and the freedom to realize even the most ambitious LED installations.

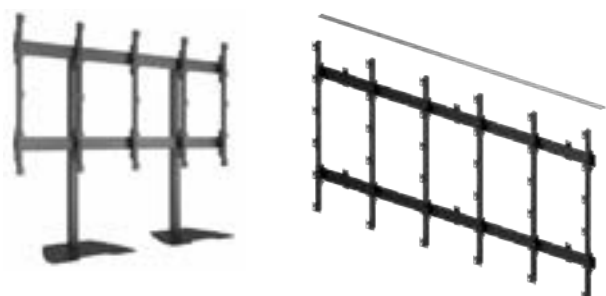

Engineered for the future, Philips LED solutions bring together trusted quality, proven efficiency, and total versatility, supported by a global network of expertise.

Customized Sidecovers



M Pro Series LED:	PHILIPS - 5000	PHILIPS - 6000	PHILIPS - 7000	PHILIPS - 8000	PHILIPS - 9000
Non Vesa Fixing:	Tailor made	Tailor made	Tailor made	Tailor made	Tailor made
EAN:	TBD	TBD	TBD	TBD	TBD
Max Load:	Tailor made for PHILIPS	Tailor made for PHILIPS	Tailor made for PHILIPS	Tailor made for PHILIPS	Tailor made for PHILIPS
Bracket type:	Fixed	Fixed	Fixed	Fixed	Fixed
Landscape / Portrait:	Yes	Yes	Yes	Yes	Yes
Quick install:	Yes	Yes	Yes	Yes	Yes
Warranty:	5 years	5 years	5 years	5 years	5 years



PRO SERIES

custo

mized

SONY

SHARP / NEC

PHILIPS

 **LG**

SAMSUNG

Customized for Samsung®

Dedicated Solutions for Samsung Displays

Samsung and Multibrackets collaborate on a wide range of proprietary solutions, designed exclusively for Samsung displays and LEDs at our facilities in Stockholm, Sweden.

From custom brackets and video wall mounts to kiosks, and LED solutions for floor, ceiling, and wall installations — Multibrackets delivers tailored products that ensure seamless integration with Samsung's advanced display technology.

With years of audio-visual manufacturing expertise, we provide reliable, well-

designed, and powerfully built solutions for projects of any scale. Backed by unmatched customer service, Multibrackets is the trusted partner for Samsung-specific installations worldwide.



NEW



Model name:	Enclosure QB13CR & QB13C-T	Enclosure QB24R & QB24C	Enclosure Totem Covered 55" Floorbase	M Pro Series Enclosure 115" Wall Slim Large Black	M Floorstand Column Pro MBFSC1UW 270 Fixed 600X1200
Screen size:	13"	24"	55"	115"	86" - 115"
VESA:	75x75, 100x100 mm	75x75, 100x100 mm	VESA 400x500 mm	1000x800	600x1200
EAN:	735007373 8519	735010521 1386	735010521 5292	734023481 2622	734023481 2509
Max load:	10 kg	10 kg	35 kg	35 kg	45 kg
Bracket type:	Fixed	Fixed	Fixed	Fixed	Fixed
Landscape/portrait:	Yes	Yes	Portrait	Portrait / landscape	Portrait
Colour:	Black	Black	Black	Black	Black
Warranty:	5 years	5 years	5 years	5 years	5 years

Customized for Samsung®

Promote Storefront Content

OM46N-D / OM55N-D

Highlights:

- Ceilingmounts and floormounts dedicated to present bright content on a dual-display
- Modernizes and saves store space with its flexible design, offers more room to market your brand or products
- Dedicated side mounting points compatible with Samsung OMND back-to-back display models
- Highest level of finish to any client branding, bespoke colors available on request
- Semi Concealed hardware for sleek & stylish aesthetics
- A standalone floor base is optional
- Durable design, Multibrackets well known quality of materials and production process
- Complete hardware kit included

OM46N-D



Floormount Pro
OM46N-D



Floorbase Pro
OM46N-D



Wheelbase Pro
OM46N-D



Ceilingmount Pro
OM46N-D



**Ceilingmount
with extension kit**
Pro OM46N-D



Wiremount Pro
OM46N-D



OM55N-D



Floormount Pro
OM55N-D



Floorbase Pro
OM55N-D



Wheelbase Pro
OM55N-D



Ceilingmount Pro
OM55N-D



**Ceilingmount
with extension kit**
Pro OM55N-D



Wiremount Pro
OM55N-D

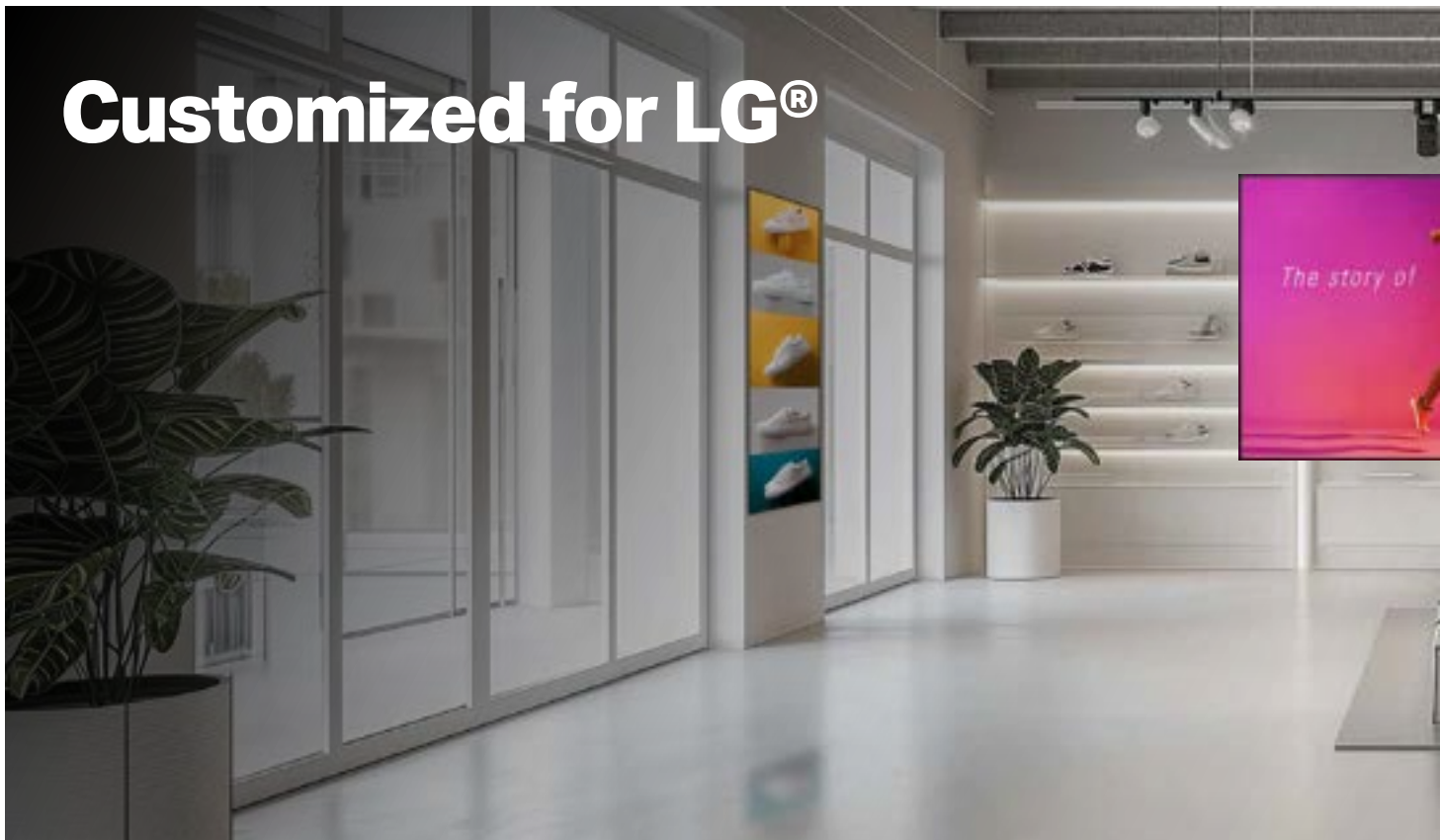

Powerful solutions for LG displays

LG's highly popular signage displays are fully supported by Multibrackets with a wide range of solutions designed exclusively for LG.

From video wall mounts and curved installations to kiosks, LED solutions, and mounting options for floors, ceilings, and walls — Multibrackets delivers complete compatibility with LG's proprietary systems.

Backed by years of audio-visual manufacturing expertise, our products combine powerful design with reliability you can trust. Dedicated to providing top-of-the-line support and service, Multibrackets is the partner of choice for LG and its network of integrators.



	Enclosure LG22SM3G	Enclosure Totem 55" Floormount White
Model name:	Enclosure LG22SM3G	Enclosure Totem 55" Floormount White
Screen size:	22"	55"
VESA:	75x75, 100x100	200x200 up to 400x500
EAN:	735010521 1041	735007373 4962
Material:	Steel	Steel
Landscape / portrait:	Yes	Portrait
Colour:	Black	Black
Warranty:	5 years	5 years



Model name:	M Wallmount Pro LG 110UM5J Tilt Black	M Floorstand Column Pro MBFSC1U 300 Fixed 1600X600	M Ceilingmount Pro LG 110UM5 Tilt Black	M Ceiling Mount Pro MBC4UHD
EAN:	735010521 3298	735010521 6749	735010521 4561	735007373 8878
VESA:	Max 1600x600mm	Max 1600x600mm	Max 1600x600mm	Max 600x400
Installation:	LG 110UM5J	LG 110UM5J, 110UM5K-B	LG 110UM5J, 110UM5K	86BH5F-M
Weight:	9 kg	24,5 kg + 40 kg	16,5 kg	54,5 kg
Max load:	80 kg	80 kg	80 kg	45 kg per screen
Measurements:	39.2x26.2x5cm	830x630x45mm + 865x355x133mm + 1160x140x138 mm	104.5 x 20 x 15 cm	105.0x51.5x18 cm
Material:	Steel, aluminum	Steel, Aluminium, Plastic (powder coated)	Steel, Aluminium, Plastic	Steel, Aluminium, Plastic
Surface finish:	Powder coating	Powder coating	Powder coating/Anodic Oxidation	Powder coating
Colour:	Black	Black	Black	Black
Warranty:	5 years	5 years	5 years	5 years



Customized for Philips®

Tailor made solutions for Philips displays

In close collaboration with Philips, Multibrackets has developed a wide range of solutions designed exclusively for Philips displays and LEDs.

Our portfolio includes specialized brackets, video wall mounts, kiosks, LED solutions, and more. With years of audio-visual manufacturing experience, we deliver well-designed, reliable, and often custom-built products that ensure seamless integration with Philips technology.

Thanks to our high-volume custom project capability, Multibrackets can support both large-scale and specialized installations. Dedicated to excellence, we provide top-of-the-line product support and service to all Philips partners worldwide.



Model name:	Enclosure 43" Wall Small Black	Enclosure Totem Covered 55" Wheelbase Black
Screen size:	43"	55"
VESA:	100x100 to 200x300	200x200 to 400x500
EAN:	735010521 1102	735010521 5315
Max load:	25 kg	35 kg
Weight:	11 kg	28,5 kg + 12 kg + 6,5 kg
Warranty:	5 years	5 years



© 2025 Multibrackets Europe. Multibrackets is a registered trademark of Multibrackets Europe AB. All rights reserved. Other parties' marks are the property of their respective owners.



Model name:	Dual 32BDL-4050D	Triple 32BDL-4050D	Dual 32BDL-4050D	Dual 49BDL-4050D
Screen size:	32"	32"	32"	32"
VESA:	VESA 200x200mm	VESA 200x200mm	VESA 400x400mm	VESA 400x400mm
EAN:	735007373 7543	735007373 7550	735007373 7574	735007373 7581
Max Load:	30kg (Per screen)	30kg (Per screen)	30kg (Per screen)	30kg (Per screen)
Bracket Type:	Fixed	Fixed	Fixed	Fixed Fixed Fixed Fixed Fixed
Pole length:	80 - 150 cm	80 - 150 cm	80 - 150 cm	80 - 150 cm
Colour:	Black	Black	Black	Black
Warranty:	5 years	5 years	5 years	5 years
Accessories:	Cover plate	Cover plate	Cover plate	Cover plate

Customized for Sharp/NEC®

Powerful solutions for Sharp/NEC displays

Multibrackets Sweden offers a complete lineup of solutions designed exclusively for Sharp/NEC displays — from specialized bracket systems and video wall mounts to trolleys and LED solutions for ceiling, wall, or floor installations.

Our long-term experience in tailoring Sharp/NEC installations, combined with outstanding high-volume custom project capabilities, makes Multibrackets the trusted partner for Sharp/NEC projects across Europe.

With decades of audio-visual manufacturing expertise, Multibrackets delivers reliable, well-designed solutions for Sharp/NEC's proprietary systems, backed by top-of-the-line support and service.



Model name:	M Pro Series Enclosure 55" Wall Medium Black	M Pro Series - Single Pole Enclosure 55" Floorbase
Screen size:	55"	55"
VESA:	200x200 up to 600x400mm	VESA 200x200 to 400x500
EAN:	735010521 1188	735007373 8427
Max load:	25 kg	50 kg
Weight:	13 kg	13 kg
Warranty:	5 years	5 years



© 2023 Multibrackets Europe. Multibrackets is a registered trademark of Multibrackets Europe AB. All rights reserved. Other parties' marks are the property of their respective owners.



Model name:	M Tilt and Roll Easel	M Wallmount Pro MBW4U Tilt Black	M Wallmount Pro MBW1UP 400x600 Fixed Black
Screen size:	32"-65"	40"-65"	40"-100"
VESA:	200x200, 300x300, 400x400, 400x600 mm	Adjustable from 100x100 to 400x400 max	From 100x100 to 400x600
EAN:	735007373 5280	735010521 5995	735007373 6935
Max Load:	50kg	35kg per screen (TÜV 30kg)	80kg
Colour:	Black	Black	Black
Warranty:	5 years	5 years	5 years

Customized for Sony, iiyama, BenQ, Hisense and more.

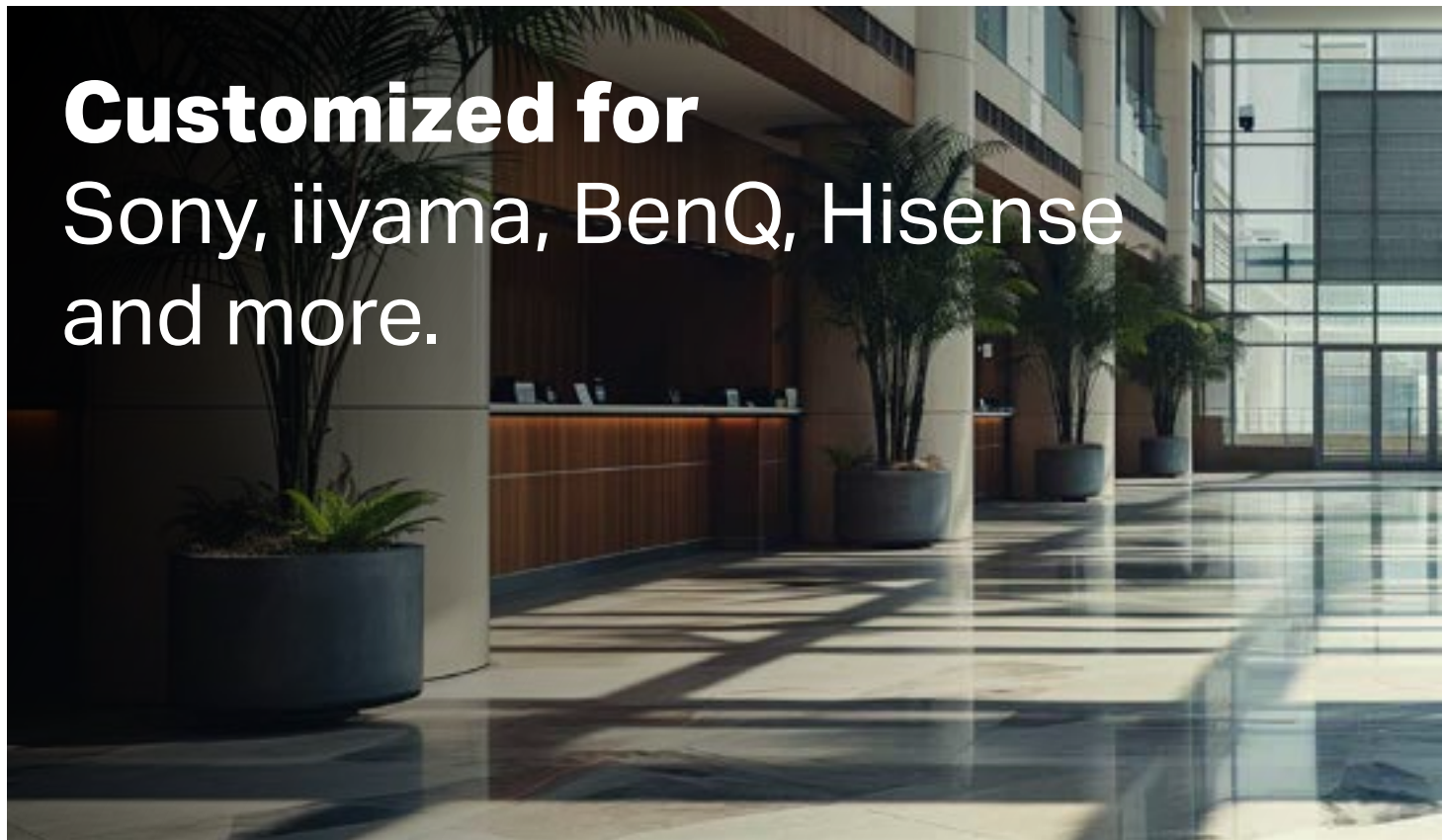

Through strong partnerships with leading AV distributors, installers, and industry innovators, Multibrackets develops head-end system-specific digital signage solutions tailored to the needs of your business.

We focus on creating simple, intuitive wall-mounting systems for digital signage as well as in-room installations — always with the goal of making setups faster, smarter, and more reliable.

Our commitment is to continually refine and expand our Pro Series product offering, ensuring solutions that combine functionality with elegance. Perhaps it's time for your business to discover a new level of performance with Multibrackets Pro Series signage solutions.



Ceiling mounts



Floorstands

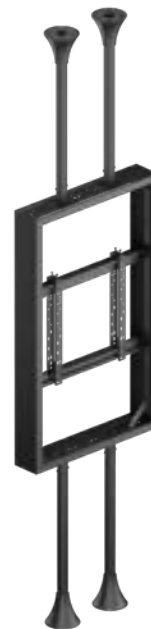

Floor to ceiling

iiyama

SONY

BENQ

Hisense

and more

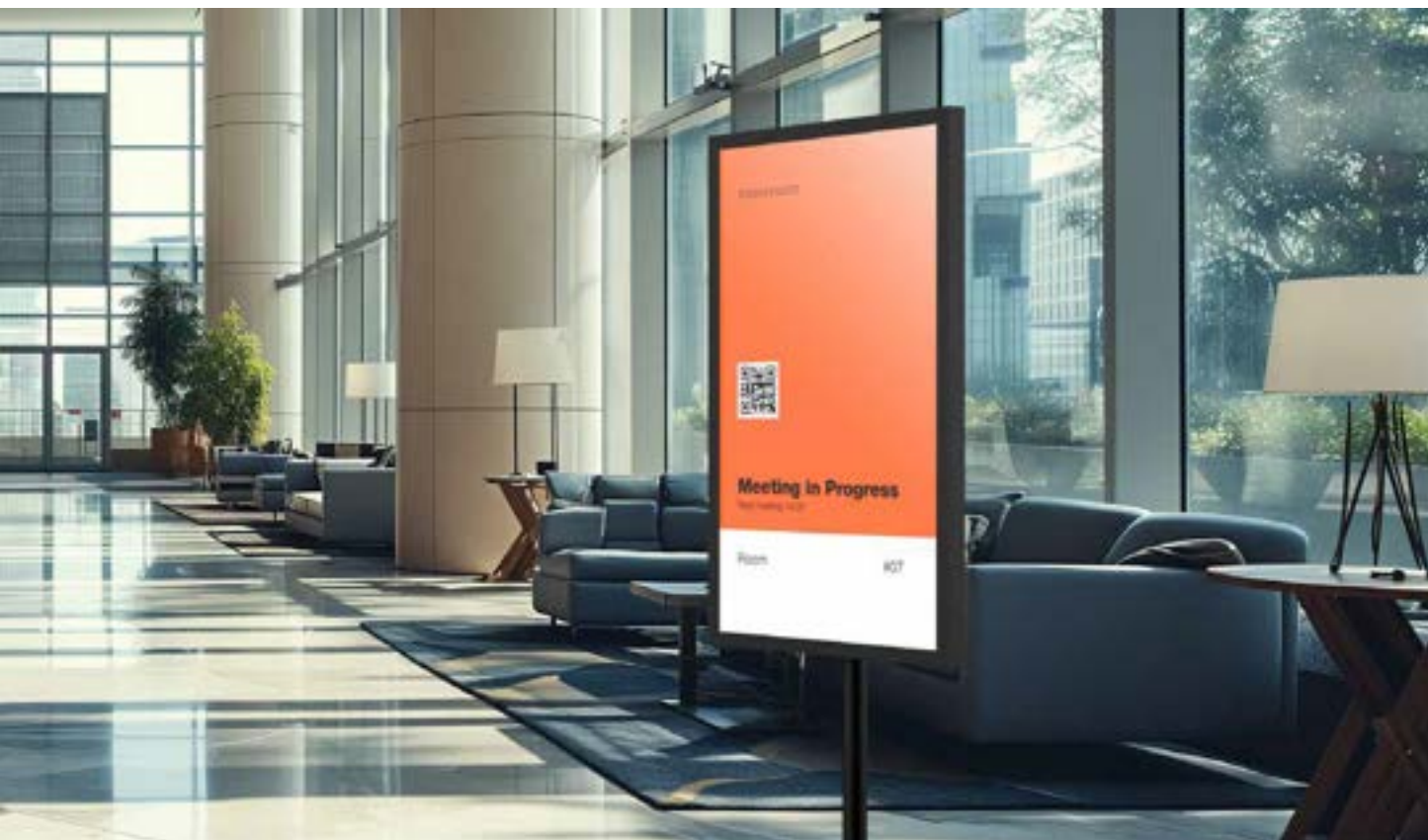

Wallmounts



Column



Ceiling mounts



Wire



Floorstands



Kiosk



Floor to ceiling



Totem

Build Control Rooms

Multiscreen display and monitor mounting for control rooms

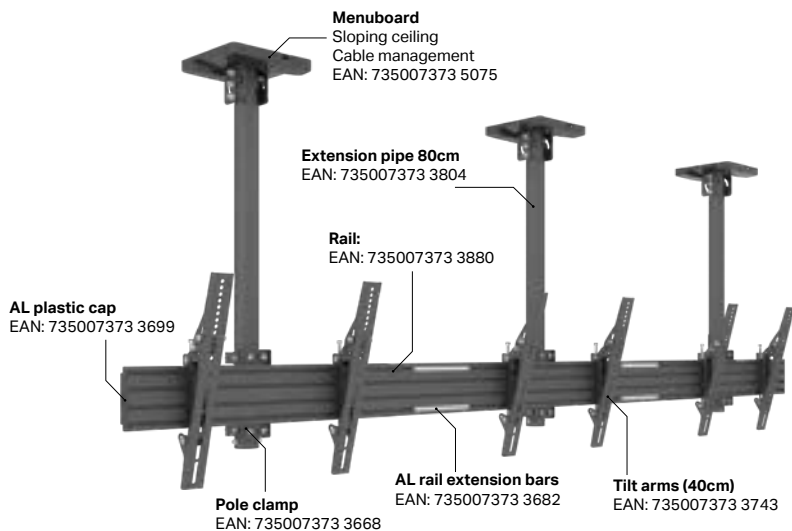

Highlights:

- Same mounting rail and system is being used
- Cable management keeps all cables in order
- Wide range of VESA handles all displays
- Easy to change design and outlook after time
- Industrial quality productrange

Pro Series Ceilingmounts

Our ceiling mount solutions are designed to support both monitors and displays, giving you complete flexibility to mix and match as needed.

With Pro Series Ceiling Mount Flexarms, you can create virtually any configuration required for your control room installation — ensuring a tailored, professional, and highly functional setup.



Pro Series Monitorwalls

Multi-screen setups, supporting several 15"-32" displays in a horizontal layout. Its modular design allows precise height and lateral adjustments

for ergonomic, efficient workspaces, ideal for control rooms, trading desks, and other demanding environments.

**Pro Series
Video/ Monitorwall**

Built on the unique Multibrackets Pro Series rail system, these video walls offer unmatched flexibility. Supporting everything from VESA 50 (common on smaller monitors) to VESA 1000x600

(for large-format displays), the system is designed to handle a wide range of setups.

Mix and match large displays with smaller monitors — with Pro Series, your imagination is the only limit.

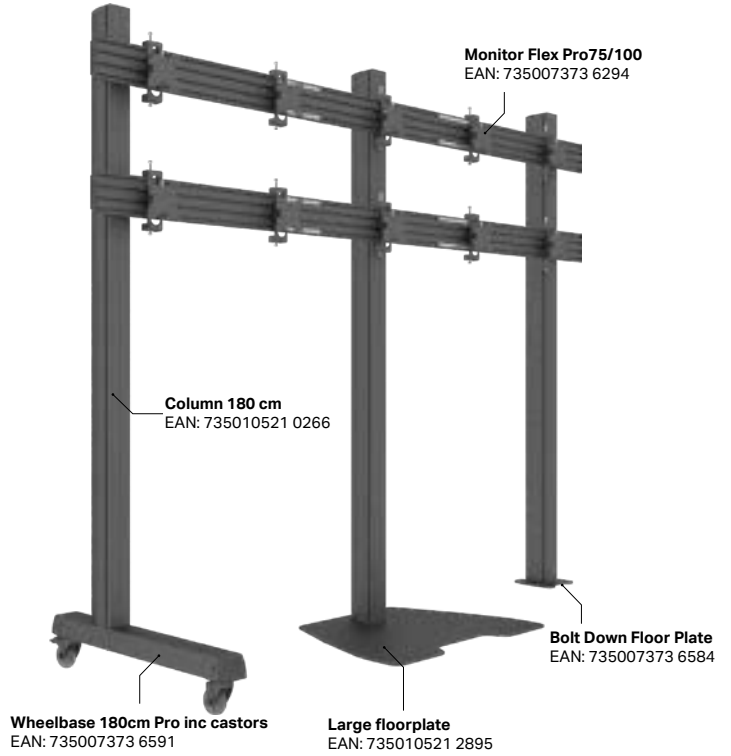

**Pro Series
Monitorstands**

For high-resolution monitor walls, the Pro Series delivers a flexible and reliable solution. Using the Pro Series rail system with fixed or tilt monitor mounts, these stands can accommodate virtually any monitor on the market.

From compact 27" screens to the latest widescreen formats, Pro Series monitor stands are designed to meet your needs with precision and versatility.

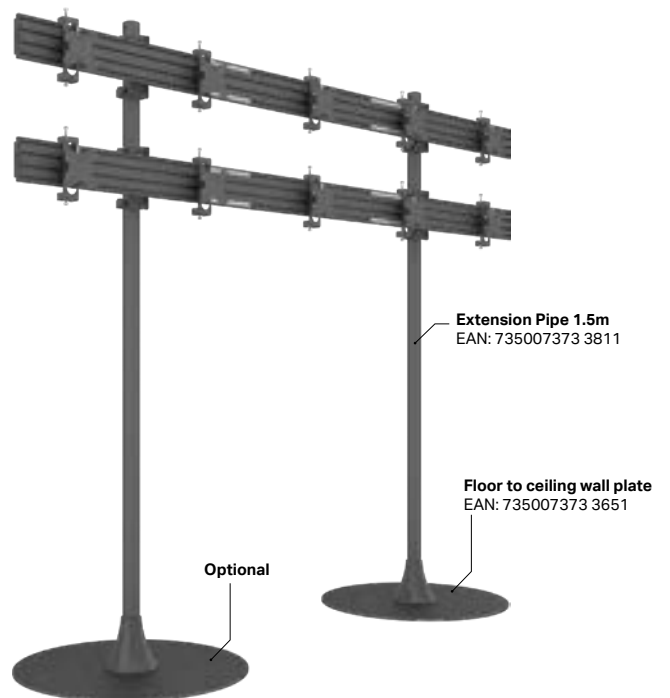

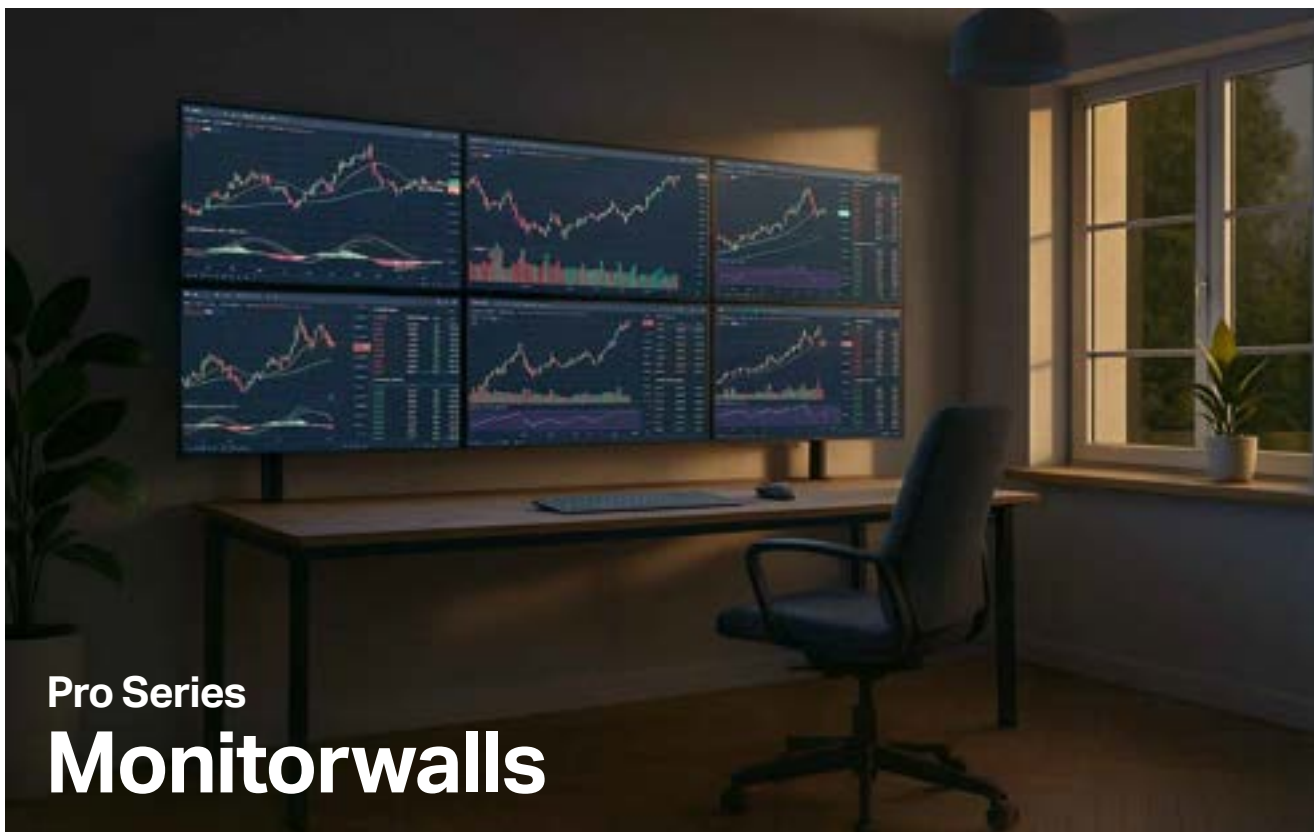

Pro Series Monitorwalls

Multibrackets Monitor Wall Systems are designed for professional environments where precision, flexibility, and reliability are essential. Built to support multiple displays in seamless configurations, they provide a clean and scalable

solution for creating high-impact visual installations. Whether used in control rooms, corporate command centers, digital signage networks, or broadcast environments, these systems deliver outstanding structural stability, effortless

alignment, and easy service access. Every detail, from micro-adjustments to integrated cable management, is engineered for performance and a refined Scandinavian aesthetic.



	M Deskmount Column Pro 2x1 MBDM2x1U	M Deskmount Column Pro 3x1 MBDM3x1U	M Deskmount Column Pro 4x1 MBDM4x1U
EAN:	735010521 5520	735010521 5957	7350105215537
Color:	Black	Black	Black
Material:	Powder coating finish	Powder coating finish	Powder coating finish
Rotate:	360°	360°	360°
Tilt:	12°	12°	12°
Screen size:	15"-32"	15"-32"	15"-32"
VESA Standard:	75x75 100x100	75x75, 100x100	75x75, 100x100
Max load:	10 kg per screen	10 kg per screen	10 kg per screen
Weight:	8,5 kg	14,5 kg	12 kg
Measurements:	104.5 x 15 x 12.5 cm	104.5 x 15,6 x 13 cm	104.5 x 15 x 14 cm
Warranty:	5 years	5 years	5 years

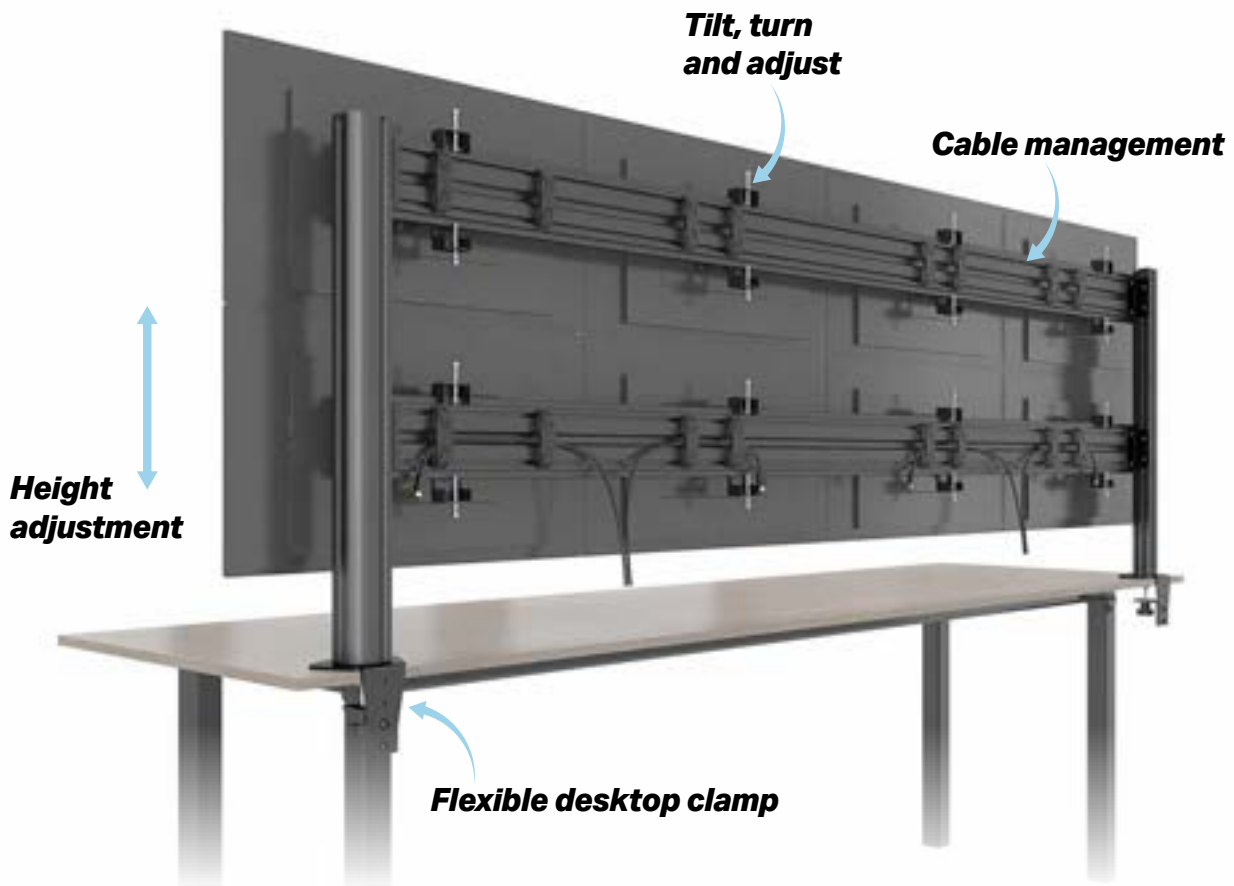

	M Deskmount Column Pro 2x2 MBDM2x2U	M Deskmount Column Pro 3x2 MBDM3x2U	M Deskmount Column Pro 4X2 MBDM4X2U
EAN:	735010521 5544	735010521 5551	735010521 5964
Color:	Black	Black	Black
Material:	Powder coating finish	Powder coating finish	Powder coating finish
Rotate:	360°	360°	360°
Tilt:	12°	12°	12°
Screen size:	15"-32"	15"-32"	15"-32"
VESA Standard:	75x75, 100x100	75x75, 100x100	75x75, 100x100
Max load:	10 kg per screen	10 kg per screen	10 kg per screen
Weight:	12,5 kg	17 kg	26 kg
Measurements:	104.5 x 15 x 14 cm	104.5 x 15 x 15 cm	104.5 x 22 x 13 cm
Warranty:	5 years	5 years	5 years



Pro Series Parts Go configure

Single AL rail 28cm (black)



EAN:	735010521 1874
Length:	28 cm
Colour:	Chrome
Material:	Aluminum
Warranty:	5 years

Single AL rail 48cm (black)



EAN:	735007373 5082
Length:	48 cm
Colour:	Black
Material:	Aluminum
Warranty:	5 years

Single AL rail 68cm (black)

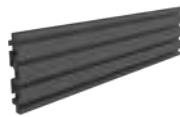

EAN:	735007373 3866
Length:	68 cm
Colour:	Black
Material:	Aluminum
Warranty:	5 years

Single AL rail 100cm (black)

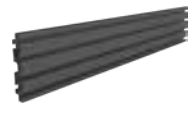

EAN:	735007373 8021
Length:	100 cm
Colour:	Black
Material:	Aluminum
Warranty:	5 years

Dual Screen Rail 196cm

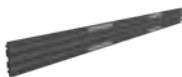

EAN:	7350073733873
Length:	196 cm
Colour:	Black
Material:	Aluminum
Warranty:	5 years

Triple Screen Rail 348cm



EAN:	7350073733880
Length:	348 cm
Colour:	Black
Material:	Aluminum
Warranty:	5 years

Rail Extension



EAN:	7350073733682
Length:	---
Colour:	Silver
Material:	Steel
Warranty:	5 years

Rail Extension Black



EAN:	7350073736867
Length:	---
Colour:	Black
Material:	Steel
Warranty:	5 years



Rail End Cover



EAN:	735007373 3699
Colour:	Black
Material:	Plastic
Warranty:	5 years

Media Storage Slide Panel



EAN:	735010521 3847
Colour:	Black
Material:	Steel
Warranty:	5 years

Curved Screen Rail Joiner



EAN:	735007373 6348
Colour:	Black
Material:	Steel (SPCC graded)
Warranty:	5 years

Cable Management Clip



EAN:	735007373 7482
Colour:	Black
Material:	Plastic
Warranty:	5 years

Rail Stopper



EAN:	735007373 7321
VESA:	---
Max Load:	---
Bracket type:	---
Colour:	Silver
Material:	Steel
Warranty:	5 years

Fixed Arms 20cm



EAN:	735007373 3903
VESA:	VESA 200, 20cm
Max Load:	30 kg
Bracket type:	Fixed
Colour:	Black
Material:	Steel (SPCC graded)
Warranty:	5 years

Fixed Arms 40cm



EAN:	735007373 3866
Colour:	Black
Max Load:	30 kg
Bracket type:	Fixed
Material:	Steel (SPCC graded)
Warranty:	5 years

Fixed Arms 60cm



EAN:	735007373 3705
Colour:	Black
Max Load:	30 kg
Bracket type:	Fixed
Material:	Steel (SPCC graded)
Warranty:	5 years

Fixed Arms 90cm



EAN:	735007373 3774
VESA:	VESA 900, 90cm
Max Load	30 kg
Bracket type:	Fixed
Colour:	Black
Material:	Steel (SPCC graded)
Warranty:	5 years

Tilt Arms 20cm



EAN:	735007373 3910
VESA:	VESA 200, 20cm
Max Load	30 kg
Bracket type:	Tilt
Colour:	Black
Material:	Steel (SPCC graded)
Warranty:	5 years

Tilt Arms 40cm



EAN:	735007373 3743
VESA:	VESA 400, 40cm
Max Load	30 kg
Bracket type:	Tilt
Colour:	Black
Material:	Steel (SPCC graded)
Warranty:	5 years

Tilt Arms 60cm



EAN:	735007373 3767
VESA:	VESA 600, 60cm
Max Load	30 kg
Bracket type:	Tilt
Colour:	Black
Material:	Steel (SPCC graded)
Warranty:	5 years

Tilt Arms 90cm



EAN:	735007373 3781
VESA:	VESA 900, 90cm
Max Load	30 kg
Bracket type:	Fixed
Colour:	Black
Material:	Steel (SPCC graded)
Warranty:	5 years

M Push in Pop out VESA 400



EAN:	735007373 4726
VESA:	VESA 400, 40cm
Max Load	30 kg
Bracket type:	Push in Pop out arms
Colour:	Black
Material:	Steel (SPCC graded)
Warranty:	5 years

M Push in Pop out VESA 600



EAN:	735010521 0464
VESA:	VESA 400, 40cm
Max Load	30 kg
Bracket type:	Push in Pop out arms
Colour:	Black
Material:	Steel (SPCC graded)
Warranty:	5 years

Extender kit 600



EAN:	735007373 4733
VESA:	VESA 600, 60cm
Max Load	30 kg
Bracket type:	---
Colour:	Black
Material:	Steel (SPCC graded)
Warranty:	5 years

40cm Micro-Adjustable Arms



EAN:	735007373 3798
VESA:	VESA 400, 40cm
Max Load	30 kg
Bracket type:	Micro-Adjustable Arms
Colour:	Black
Material:	Steel (SPCC graded)
Warranty:	5 years

60cm Micro-Adjustable Arms



EAN:	735010521 0457
VESA:	VESA 400, 40cm
Max Load	30 kg
Bracket type:	Push in Pop out arms
Colour:	Black
Material:	Steel (SPCC graded)
Warranty:	5 years

M Monitor Fixed Pro 50/75/100



EAN:	735007373 6300
VESA:	50x50, 75x75, 100x100
Max Load	15 kg
Bracket type:	Fixed
Colour:	Black
Material:	Steel (SPCC graded)
Warranty:	5 years

M Monitor Flex Pro 50/75/100



EAN:	735007373 6294
VESA:	50x50, 75x75, 100x100
Max Load	15 kg
Bracket type:	Tilt
Colour:	Black
Material:	Steel (SPCC graded)
Warranty:	5 years

VESA Flexarm Pro 400



EAN:	735007373 6331
VESA:	400x400mm
Colour:	Black
Material:	Steel (SPCC graded)

VESA Flexarm Pro Portrait



EAN:	735010521 2499
VESA:	600x400mm
Colour:	Black
Material:	Steel (SPCC graded)

Dual Pole bracket 600X900











EAN:	735007373 8854
VESA:	600X900mm
Colour:	Black
Material:	Steel (SPCC graded)

Dual Pole bracket 800X600



EAN:	735007373 8847
VESA:	800x600mm
Colour:	Black
Material:	Steel (SPCC graded)

	Fixed Arms 300mm	Tilt Arms 300mm	Fixed Arms 1200mm	Fixed Arms 1600mm
				
EAN:	735010521 6282	735010521 6176	735010521 3922	735002273 3947
VESA:	VESA 300, 30cm	VESA 300, 30cm	---	---
Max Load	30 kg	30 kg	150 kg	150 kg
Bracket type:	Fixed	Tilt	Fixed	Fixed
Colour:	Black	Black	Black	Black
Material:	Steel (SPCC graded)	Steel (SPCC graded)	Steel (SPCC graded)	Steel (SPCC graded)
Warranty:	5 years	5 years	5 years	5 years
	Extender kit - Fixed Arms 1200mm	Extender kit - Fixed Arms 1600mm	VESA Mount Fixed 50/75/100/200	Monitor Mount B2B Pro 50/75/100
				
EAN:	735002273 3954	735002273 3961	735010521 9030	735010521 9887
Max Load	---	---	45 kg	45 kg per screen
Colour:	Black	Black	Black	Black
Material:	Steel (SPCC graded)	Steel (SPCC graded)	Steel (SPCC graded)	Steel (SPCC graded)
Warranty:	5 years	5 years	5 years	5 years



Wallmount Plate Slim Small



EAN: 735007373 6980
Colour: Black
Material: Steel (SPCC graded)
Warranty: 5 years

Wallmount Plate Small



EAN: 735007373 4184
Colour: Black
Material: Steel (SPCC graded)
Warranty: 5 years

Wallmount Plate Large



EAN: 735007373 3675
Colour: Black
Material: Steel (SPCC graded)
Warranty: 5 years

Pole Clamp Plate



EAN: 735007373 6119
Colour: Black
Material: Steel (SPCC graded)
Warranty: 5 years

Single display plate from wall



EAN: 735007373 7338
Colour: Black
Material: Steel (SPCC graded)
Warranty: 5 years

B2B display plate from wall



EAN: 735007373 7345
Colour: Silver
Material: Steel (SPCC graded)
Warranty: 5 years

Ceiling Plate HD



EAN: 735007373 4696
Colour: Black
Material: Steel (SPCC graded)
Warranty: 5 years

Ceiling Plate with Cover Black



EAN: 735007373 5075
Colour: Black
Material: Steel (SPCC graded)
Warranty: 5 years

Ceiling Plate with Cover White



EAN: 735007373 9028
Colour: White
Material: Steel (SPCC graded)
Warranty: 5 years

I-Beam Clamp



EAN: 735007373 6386
Colour: Black
Material: Steel (SPCC graded)
Warranty: 5 years

Connecting plate



EAN: 735007373 6973
Colour: Black
Material: Steel (SPCC graded)
Warranty: 5 years

Dual bracket V-shape 32"-43"



EAN: 735010521 2475
Colour: Black
Material: Steel (SPCC graded)
Warranty: 5 years

Dual bracket V-shape 46"-65"



EAN: 735010521 2482
Colour: Black
Material: Steel (SPCC graded)
Warranty: 5 years

Extension Pipe 0.8m Black



EAN: 735007373 3804
Colour: Black
Material: Steel (SPCC graded)
Warranty: 5 years

Extension Pipe 1.5m Black



EAN: 735007373 3811
Colour: Black
Material: Steel (SPCC graded)
Warranty: 5 years

Extension Pipe 3m Black



EAN: 735007373 3828
Colour: Black
Material: Steel (SPCC graded)
Warranty: 5 years

Extension Pipe 0.8m White



Extension Pipe 1.5m White



Extension Pipe 3m White



Chrome Extension Pipe 3m



EAN:	735007373 6140	735007373 6157	735007373 6164	735007373 3835
Colour:	White	White	White	White
Material:	Steel (SPCC graded)	Steel (SPCC graded)	Steel (SPCC graded)	Steel (SPCC graded)
Warranty:	5 years	5 years	5 years	5 years

Brass Extension Pipe 3m



External Pipe Cover Brass



External Pipe Cover Brass



External Pipe Cover White



EAN:	735007373 3842	735007373 6225	735007373 4221	735007373 6201
Colour:	Brass	Brass	Black	White
Material:	Steel (SPCC graded)	Plastic	Plastic	Plastic
Warranty:	5 years	5 years	5 years	5 years

External Pipe Cover Chrome



Floor To Ceiling Plate Black



Floor To Ceiling Plate Brass



Floor To Ceiling Plate Chrome



EAN:	735007373 6218	735007373 3651	735007373 6195	735007373 6188
Colour:	White	Black	Brass	Chrome
Material:	Plastic	Plastic + Steel (SPCC graded)	Plastic + Steel (SPCC graded)	Plastic + Steel (SPCC graded)
Warranty:	5 years	5 years	5 years	5 years

Floor To Ceiling Plate White



Inner Ceiling Plate Cover Black



Inner Ceiling Plate Cover White



Internal Pole Joiner



EAN:	735007373 3859	735007373 6270	735007373 6287	735007373 4191
Colour:	White	Black	White	Chrome
Material:	Plastic + Steel (SPCC graded)	Plastic	Plastic	Steel (SPCC graded)
Warranty:	5 years	5 years	5 years	5 years



Pole Clamp



EAN: 735007373 3668
Colour: Black
Material: Steel (SPCC graded)
Warranty: 5 years

Dual Pole Clamp



EAN: 735007373 5068
Colour: Black
Material: Steel (SPCC graded)
Warranty: 5 years

Pole Clamp Wall Bracket



EAN: 735007373 4177
Colour: Black
Material: Steel (SPCC graded)
Warranty: 5 years

Pole Drill Fixture



EAN: 735007373 4214
Colour: Black
Material: Steel (SPCC graded)
Warranty: 5 years

Truss Clamp 45-51mm



EAN: 735007373 4320
Colour: Black
Material: Steel (SPCC graded)
Warranty: 5 years

Wheelbase 180cm Pro inc castors



EAN: 735007373 6591
Colour: Black
Material: Aluminum + Steel (SPCC graded)
Warranty: 5 years

Wheelbase 270cm Pro inc castors



EAN: 735007373 6607
Colour: Black
Material: Aluminum + Steel (SPCC graded)
Warranty: 5 years

Wheelbase 300cm Pro inc castors



EAN: 735007373 6614
Colour: Black
Material: Aluminum + Steel (SPCC graded)
Warranty: 5 years

External Pipe Cover Chrome



EAN: 735007373 6218
Colour: White
Material: Plastic
Warranty: 5 years

Floor To Ceiling Plate Black



EAN: 735007373 3651
Colour: Black
Material: Plastic + Steel (SPCC graded)
Warranty: 5 years

Floor To Ceiling Plate Brass



EAN: 735007373 6195
Colour: Brass
Material: Plastic + Steel (SPCC graded)
Warranty: 5 years

Internal Pole Joiner



EAN: 735007373 4191
Colour: Chrome
Material: Plastic + Steel (SPCC graded)
Warranty: 5 years

Column 150cm



EAN: 735010521 0259
Colour: Black
Material: Aluminum
Warranty: 5 years

Column 180cm



EAN: 735010521 0266
Colour: Black
Material: Aluminum
Warranty: 5 years

Column 270cm



EAN: 735010521 0273
Colour: Black
Material: Aluminum
Warranty: 5 years

Column 300cm



EAN: 735010521 2550
Colour: Black
Material: Aluminum
Warranty: 5 years

Bolt Down Floor Plate

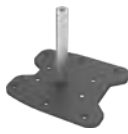

Base Plate



Large Floorplate



Bolt Down Pole Plate



EAN:	735007373 6584	735007373 6447	735010521 2895	735010521 0471
Colour:	Black	Black	Black	Black
Material:	Steel (SPCC graded)	Steel (SPCC graded)	Steel (SPCC graded)	Steel (SPCC graded)
Warranty:	5 years	5 years	5 years	5 years

Bolt Down Dual Pole Plate



Large Floorbase



Camera Shelf



Camera Shelf Column



EAN:	735010521 6305	735010521 4219	735007373 6638	735010521 5858
Colour:	Black	Black	Black	Black
Material:	Steel (SPCC Graded)	Steel (SPCC Graded)	Steel (SPCC graded)	Steel (SPCC Graded)
Warranty:	5 years	5 years	5 years	5 years

M Universal Soundbar Mount and Camera Holder Large



Soundbar Holder



Soundbar Holder XL



M Pro Series - AV Shelf



EAN:	735010521 4202	735007373 6645	735010521 5629	735007373 6430
Colour:	Black	Black	Black	Black
Material:	Steel (SPCC Graded)	Steel (SPCC graded)	Steel (SPCC Graded)	Steel (SPCC graded)
Warranty:	5 years	5 years	5 years	5 years

M Pro Series - AV Shelf Dual Pole



M Pro Series - AV Shelf Column



Wheelbase Supportbar 750mm



Wheelbase Supportbar 1200mm



EAN:	734023481 1830	735010521 5865	735010521 3045	735010521 3052
Colour:	Black	Black	Black	Black
Material:	Steel (SPCC graded)	Steel (SPCC graded)	Steel (SPCC graded)	Steel (SPCC graded)
Warranty:	5 years	5 years	5 years	5 years

**Floor Support
1025-1075mm Black**



EAN:	735010521 3540
Colour:	Black
Material:	Steel (SPCC graded)
Warranty:	5 years

**Ceiling Plate w.
Weight Balance**



EAN:	735010521 3649
Colour:	Black
Material:	Steel (SPCC graded)
Warranty:	5 years

Anti-theft Mini



EAN:	735002273 5033
Colour:	Chrome
Material:	Steel (SPCC graded)
Warranty:	5 years

**Anti Theft
Screws Pack M8**



EAN:	735010521 4318
Colour:	Chrome
Material:	Steel (SPCC graded)
Warranty:	5 years

**Anti Theft
Screws Pack M5 M6**



EAN:	735007373 4191
Colour:	Chrome
Material:	Steel (SPCC graded)
Warranty:	5 years

Fixed Arm 126cm

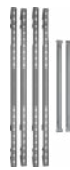

EAN:	735010521 3922
Colour:	Black
Material:	Steel (SPCC Graded)
Warranty:	5 years

Extender Kit Push X Small 200x200



EAN:	735010521 5322
Colour:	Black
Material:	Steel (SPCC Graded)
Warranty:	5 years

Camera Holder Large



EAN:	7 350 105 214 219
Colour:	Black
Material:	Steel (SPCC Graded)
Warranty:	5 years

**VESA Face Down Mount
200/300/400**



EAN:	7 350 105 215 902
Colour:	Black
Material:	Steel (SPCC Graded)
Warranty:	5 years

Dome Camera Mount



EAN:	735010521 6275
Colour:	Black
Material:	Steel (SPCC Graded)
Warranty:	5 years

Fixed Arms Wire 400x600 Single



EAN:	735010521 5902
Colour:	Black
Material:	Steel (SPCC Graded)
Warranty:	5 years

Fixed Arms Wire 400x600 Dual



EAN:	735010521 6275
Colour:	Black
Material:	Steel (SPCC Graded)
Warranty:	5 years

Wire Kit 3000mm



EAN:	735010521 6510
Colour:	Black
Material:	Steel (SPCC Graded)
Warranty:	5 years

Wire Kit 6000mm



EAN:	735010521 6527
Colour:	Black
Material:	Steel (SPCC Graded)
Warranty:	5 years

Ceiling Wire Kit 3000



EAN:	735002273 8713
Colour:	Chrome
Material:	Steel (SPCC graded)
Warranty:	5 years

Ceiling Wire Kit 6000



EAN:	735002273 8720
Colour:	Chrome
Material:	Steel (SPCC graded)
Warranty:	5 years

Fixed Arms Wire 400x600 Single



EAN: 735010521 6534
Colour: Black
Material: Steel (SPCC graded)
Warranty: 5 years

Fixed Arms Wire 400x600 Dual



EAN: 735010521 6541
Colour: Black
Material: Steel (SPCC graded)
Warranty: 5 years

Face Down Ceiling Adapter



EAN: 735010521 7272
Colour: Black
Material: Steel (SPCC graded)
Warranty: 5 years

Tripod Stand column 150cm



EAN: 735010521 7449
Colour: Black
Material: Steel (SPCC graded)
Warranty: 5 years

Cable Management Clip 2-pack, 1 Pipe Cover, 2 Side Cover



EAN: 735010521 7609
Colour: Black
Material: Plastic
Warranty: 5 years

Base 75cm Single



EAN: 735010521 7791
Colour: Black
Material: Steel (SPCC graded)
Warranty: 5 years

Base 100cm Single

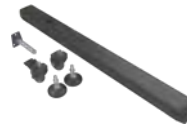

EAN: 735010521 7807
Colour: Black
Material: Steel (SPCC graded)
Warranty: 5 years

Base 130cm Single

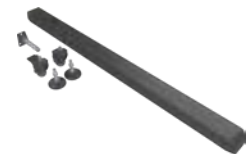

EAN: 735010521 7814
Colour: Black
Material: Steel (SPCC graded)
Warranty: 5 years

Round Floorplate



EAN: 735010521 7593
Colour: Black
Material: Steel (SPCC graded)
Warranty: 5 years

Wheelbase Single Column 75cm



EAN: 735007373 8366
Colour: Black
Material: Steel (SPCC graded)
Warranty: 5 years

Wheelbase Single Column 100cm



EAN: 735007373 8373
Colour: Black
Material: Steel (SPCC graded)
Warranty: 5 years

Shelf Mount 75x75 100x100 White



EAN: 735002273 1127
Colour: White
Material: Steel (SPCC graded)
Warranty: 5 years

Column 60cm



EAN: 735002273 5187
Colour: Black
Material: Aluminum
Warranty: 5 years

Column 100cm



EAN: 735002273 7006
Colour: Black
Material: Aluminum
Warranty: 5 years

Column 120cm



EAN: 735002273 7020
Colour: White
Material: Aluminum
Warranty: 5 years

Column 400cm



EAN: 735002273 9291
Colour: Black
Material: Aluminum
Warranty: 5 years

VESA Tilt Column Mount



EAN: 735002273 5149
Colour: Black
Material: Steel (SPCC graded)
Warranty: 5 years

Small Floor Plate

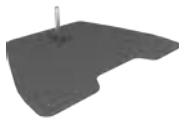

EAN: 735002273 7013
Colour: Black
Material: Steel (SPCC graded)
Warranty: 5 years

Adjustable Feet Pro

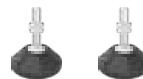

EAN: 735007373 6577
Colour: Black
Material: Plastic + Steel (SPCC Graded)
Warranty: 5 years

Anti Theft Screws Pack Enclosures/ Casings



EAN: 735010521 5278
Colour: Chrome
Material: Stainless steel
Warranty: 5 years

AV Shelf Column



EAN: 735010521 5865
Colour: Black
Material: Steel (SPCC graded)
Warranty: 5 years

MBW1U Tilt Black – Wallbox



EAN: 735010521 7821
Colour: Black
Material: Steel (SPCC graded)
Warranty: 5 years

Fixed Plate Wire



EAN: 734023481 1090
Colour: Black
Material: Steel (SPCC graded)
Warranty: 5 years

Fixed Plate Wire B2B



EAN: 734023481 1335
Colour: Black
Material: Steel (SPCC graded)
Warranty: 5 years

LED Rail 100cm



EAN: 734023481 1243
Colour: Black
Material: Steel (SPCC graded)
Warranty: 5 years

LED Adapter plate 60x17mm



EAN: 734023481 1182
Colour: Chrome
Material: Aluminum
Warranty: 5 years

LED Adapter plate 60x17mm



EAN: 734023481 1199
Colour: Black
Material: Steel (SPCC graded)
Warranty: 5 years

LED Micro-Adjustable Adapter



EAN: 734023481 1236
Colour: Chrome
Material: Steel (SPCC graded)
Warranty: 5 years

VESA Extension kit 400x400



EAN: 735010521 9047
VESA: 200x200/300x300/400x400mm
Weight: 4 kg
Colour: Black
Material: Aluminum
Warranty: 5 years

Rotating Mount Ring



EAN: 734023481 2301
Weight: 0.5 kg
Colour: Black
Material: Steel (SPCC Graded)
Warranty: 5 years



Visit our showroom

Sveavägen 140, 113 50 Stockholm, Sweden. +46-8-6150400

Enclosure parts

Enclosure Holder Small 220mm



EAN: 735010521 6435

Colour: Black

Material: Steel

Warranty: 5 years

Enclosure Holder Medium 340mm



EAN: 735010521 6442

Colour: Black

Material: Steel

Warranty: 5 years

Enclosure Holder Large 550mm



EAN: 735010521 6459

Colour: Black

Material: Steel

Warranty: 5 years

Enclosure B2B Pole Connector



EAN: 735007373 2166

Colour: Black

Material: Steel

Warranty: 5 years

Floor to Ceiling Kit Large Black



EAN: 735010521 5698

Colour: Black

Material: Steel

Warranty: 5 years

Floor to Ceiling Kit Large White



EAN: 735010521 5704

Colour: White

Material: Steel

Warranty: 5 years

1500mm Pipe Connecting Plate Large Black



EAN: 735010521 1591

Colour: Black

Material: Steel

Warranty: 5 years

1500mm Pipe Connecting Plate Large White

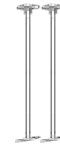

EAN: 735010521 1607

Colour: White

Material: Steel

Warranty: 5 years

Floor to Ceiling Kit Medium Black



EAN: 735010521 1645

Colour: Black

Material: Steel

Warranty: 5 years

Floor to Ceiling Kit Medium White



EAN: 735010521 1652

Colour: Black

Material: Steel

Warranty: 5 years

1500mm Wire Connecting Plate Small



EAN: 735010521 1522

Colour: Chrome

Material: Steel

Warranty: 5 years

1500mm Wire Connecting Plate Medium



EAN: 735010521 1539

Colour: Chrome

Material: Steel

Warranty: 5 years

1500mm Wire Connecting Plate Large



EAN: 735010521 1546

Colour: Chrome

Material: Steel

Warranty: 5 years

Landscape Installation Template Black



EAN: 735010521 1614

Colour: Black

Material: Steel

Warranty: 5 years

Wheelbase Indoor Totem 55"



EAN: 735010521 4790

Colour: Black

Material: Steel

Warranty: 5 years

Wheelbase Indoor Totem 55"White











EAN: 735007373 4948





Colour: White

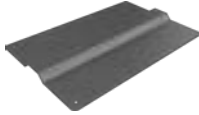

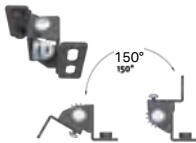

Material: Steel

Warranty: 5 years

	Enclosure Totem Full Front Cover 55" Black	Enclosure Totem Full Front Cover 55" White	Enclosure Totem Full Front Cover 55" B2B Black	Enclosure Totem Full Front Cover 55" B2B White
				
EAN:	735010521 5285	735007373 4931	734023481 1069	734023481 1076
Colour:	Black	White	Black	White
Material:	Steel	Steel	Steel	Steel
Warranty:	5 years	5 years	5 years	5 years

	Enclosure Totem Full Front Cover 55" B2B Black	Enclosure Totem Full Front Cover 55" B2B White	Floorbase Indoor Totem 55"	Floorbase Indoor Totem 55" White
				
EAN:	734023481 1069	734023481 1076	735010521 4783	735007373 4955
Colour:	Black	White	Black	White
Material:	Steel	Steel	Steel	Steel
Warranty:	5 years	5 years	5 years	5 years

	Enclosure Fixed Arms 600mm	Extender kit 600 Enclosure	Curved Display Distance	Pole Clamp Ring
				
EAN:	735007373 7314	735010521 8064	735010521 2284	735010521 3571
Colour:	Black	Black	Black	Black
Material:	Steel	Steel	Steel (SPCC graded)	Steel (SPCC graded)
Warranty:	5 years	5 years	5 years	5 years

	1500mm Pipe Connecting Plate Small Black	1500mm Pipe Connecting Plate Small White	Enclosure Ceiling Kit 49"-65" Black	Enclosure Ceiling Kit 46"-65" White
				
EAN:	735010521 1553	735010521 1560	735010521 1577	735010521 1584
Colour:	Black	White	Black	White
Material:	Steel	Steel	Steel	Steel
Warranty:	5 years	5 years	5 years	5 years



Enclosure 85" Back Plate Large Black

Colour: Black

EAN: 735010521 1461

Compatible with: Enclosure 85"

Material: Steel



Enclosure 85" Back Plate Large White

Colour: White

EAN: 735010521 1478

Compatible with: Enclosure 85"

Material: Steel



Enclosure 86" Back Plate Large Black

Colour: Black

EAN: 735010521 1324

Compatible with: Enclosure 86"

Material: Steel



Enclosure 86" Back Plate Large White

Colour: White

EAN: 735010521 1331

Compatible with: Enclosure 86"

Material: Steel



Enclosure 98" Back Plate Large Black

Colour: Black

EAN: 735010521 1362

Compatible with: Enclosure 98"

Material: Steel



Enclosure 98" Back Plate Large White

Colour: White

EAN: 735010521 1379

Compatible with: Enclosure 98"

Material: Steel

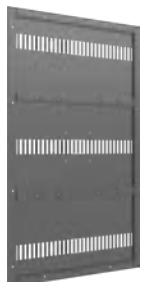

Enclosure 46" Back Plate Small Black

Colour: Black

EAN: 735010521 9375

Compatible with: Enclosure 46"

Material: Steel



Enclosure 46" Back Plate Small White

Colour: White

EAN: 735010521 9382

Compatible with: Enclosure 46"

Material: Steel



Enclosure 49" High Brightness Frame

Colour: White

EAN: 735002273 6924

Screen size: Enclosure 49"

Material: Steel

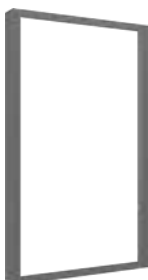

Enclosure 49" High Brightness Frame

Colour: Black

EAN: 735002273 8751

Screen size: Enclosure 49"

Material: Steel



Enclosure 75" Frame High Brightness

Colour: White

EAN: 735002273 8683

Screen size: Enclosure 75"

Material: Steel



Enclosure 75" Frame High Brightness

Colour: Black

EAN: 735002273 8676

Screen size: Enclosure 75"

Material: Steel

Enclosure Safety Sheets

Function and freedom for the installer

Multibrackets polycarbonate safety sheets are designed specifically for our series of enclosures, providing an extra layer of protection for digital signage displays. Built with safety in mind, they safeguard against tampering, theft, and accidental damage.

Ideal for public environments such as entrances, hospitals, and other high-traffic areas,

these safety sheets combine durability with a sleek, modern appearance.

Engineered to complement the latest digital signage displays housed in Multibrackets enclosures, they offer both security and style — ensuring peace of mind without compromising design.

From 13" to 98"



Model:	Safety Sheet Polycarbonate 13"	Safety Sheet Polycarbonate 22"	Safety Sheet Polycarbonate 24"	Safety Sheet Polycarbonate 32"
EAN:	735010521 4868	735010521 4875	735010521 4882	735010521 4899
For screen size:	13"	22"	24"	32"
Material:	Plastic	Plastic	Plastic	Plastic
Color:	Transparent	Transparent	Transparent	Transparent
Model:	Safety Sheet Polycarbonate 43"	Safety Sheet Polycarbonate 49"	Safety Sheet Polycarbonate 50"	Safety Sheet Polycarbonate 55"
EAN:	735010521 4035	735010521 9962	735010521 4905	735010521 4042
For screen size:	43"	49"	50"	55"
Material:	Plastic	Plastic	Plastic	Plastic
Color:	Transparent	Transparent	Transparent	Transparent
Model:	Safety Sheet Polycarbonate 65"	Safety Sheet Polycarbonate 75"	Safety Sheet Polycarbonate 85"	Safety Sheet Polycarbonate 86"
EAN:	735010521 4912	735010521 4929	735002273 8942	735007373 1503
For screen size:	65"	75"	85"	86"
Material:	Plastic	Plastic	Plastic	Plastic
Color:	Transparent	Transparent	Transparent	Transparent
Model:	Safety Sheet Polycarbonate 98"			
EAN:	735007373 1510			
For screen size:	98"			
Material:	Plastic			
Color:	Transparent			

Cable management

What makes Cable Socks special and why are they needed?

Exposed cables are vulnerable to abrasion, UV damage, and general wear, especially in high-traffic or high-friction environments. Multibrackets Cable Socks protect and extend the lifespan of your cables, helping reduce long-term maintenance costs.



Highlights:

- Expands easily to ensure complete coverage and protection.
- Offers general protection from abrasion, chemicals and temperature for optimal protection.
- Available in various sizes and colors.
- Designed to adjust and expand to irregular shapes.
- Keeps its flexibility under a wide range of temperatures and over time.
- Constructed from tightly woven polyester material.
- Provides easy installation on already existing applications simply unwrap the cable sock and apply directly to your cable or product.
- Highly versatile with flexible properties, excellent for office/commercial/ industrial uses.

Unlike traditional braided sleeving or wire loom, our Cable Socks install quickly without special tools or tedious sliding. The available colour options also make it easy to colour-code and identify your cable infrastructure.

Ideal for AV and computer cables, server halls, data centres (including optical cables with our 5 mm version), hospitals, hotel rooms, and any setting that requires durable, high-quality cable protection. All Multibrackets Cable Socks are also fire-retardant.

M Universal Cable Socks Self Wrapping

Material:	Polyester
Self wrapping:	Yes
Sock length:	25 m
Working temp. :	-50°C-+ 150°C
Melting point:	240±10°C
Flammability:	8s6853 lb UL94 V-0 FMVSS 302
Monofilament diameter:	0.25mm
Safety:	Fire retardant material
Certificate:	RoHS
Warranty:	5 years
Weight:	Depending on size

Wear-resisting level:
ISO6722, Load 7N, Number of scratches ≥3000 times, high wear resistance.

Application:
It is widely used in electrical wiring, cables, wiring harness and hoses for high-speed trains, cars, automation equipment, instruments, and especially for irregularly wiring harness.



M Cable Sock Quicktool

EAN:	735007373 4689
Colour:	Blue
Warranty:	1 year



M Cable Sock Heat Cutter

EAN:	735002273 2926
Colour:	Light Blue
Warranty:	1 year

	5 - 9mm	10 - 14mm	19 - 30mm	25 - 35mm	40 - 50mm
Yellow					
	735007373 4382	735007373 4429	735007373 4467	735007373 4504	735007373 4542
Orange					
	735007373 4399	735007373 4436	735007373 4474	735007373 4511	735007373 4559
Red					
	735007373 4412	735007373 4450	735007373 4498	735007373 4535	735007373 4573
Blue					
	735007373 4405	735007373 4443	735007373 4481	735007373 4528	735007373 4566
White					
	735007373 3194	735007373 3224	735002273 4203	735007373 2777	735007373 2807
Grey					
	735007373 3200	735007373 3231	735002273 4180	735007373 2784	735007373 2814
Black					
	735007373 3217	735007373 3248	735002273 4197	735007373 2791	735007373 2821

Multibrackets

Everything starts with you.

Great products are born by putting the user at the heart of everything we do.

Mission

At Multibrackets, our mission is to create products that are simple to install and easy to use - solutions that excite and meet our clients' everyday needs, all year round. Based in Stockholm, Sweden, we design, develop, and market AV equipment in our own way: with genuine passion for technology and user-centric innovation. Every product is infused with a touch of Multibrackets magic.

About us

Founded in 2000, we are a family-owned company represented in more than 30 countries. Today, Multibrackets is recognized as one of the leaders in the rapidly evolving field of digital signage technology. Together with our distributor network, we deliver hardware and services that transform ideas into ready-to-use solutions.

With one of the most comprehensive product lines in Europe, we supply AV equipment for virtually every need - and our reputation for innovation is well established across the industry.

Become a partner

Stay ahead of the competition - become a Multibrackets partner. Simply email us at support@multibrackets.com or visit products.multibrackets.com/en/contact to connect with our team. We'll help you establish contact with a distributor and get started. We look forward to hearing from you.

Contact details

Multibrackets Europe AB
Sveavägen 140 BV
SE-113 50 Stockholm
SWEDEN

support@multibrackets.com
+46 (0)8 - 615 04 00

Sustainability

At Multibrackets, we see sustainability as an ongoing journey. Being part of the AV industry means carrying responsibility for the environment and for everyone involved in making our products.

We are committed to designing sustainable solutions, reducing our environmental impact, improving sourcing practices, and creating a great workplace for our employees. Find out more about our initiatives and achievements on our website.

Copyright

This catalogue is protected under copyright law. Its design, content, and images may not be reproduced, published, displayed, or distributed, in whole or in part, without prior written consent from Multibrackets Europe AB.

The content is the intellectual property of Multibrackets Europe AB and is subject to both EU and U.S. copyright law (Act of 1976, Title 17, United States Code). If you are a Multibrackets customer and would like permission to use our material in your company publication, please contact us. Permission may be granted on condition that proper credit is given to Multibrackets Europe AB.

Disclaimer - Printing Errors

While we strive to provide accurate information, misprints and errors may occur. If incorrect product details or specifications are published, we will correct them as soon as possible.

We reserve the right to cancel any order placed based on misprinted information. Furthermore, Multibrackets Europe AB reserves the right to edit, update, or remove content in this catalogue at any time without prior notice.

Welcome

Thank you for choosing Multibrackets Europe AB, one of Europe's leading manufacturers of audio-visual equipment.

All rights reserved, Multibrackets®, Stockholm, Sweden, 2026

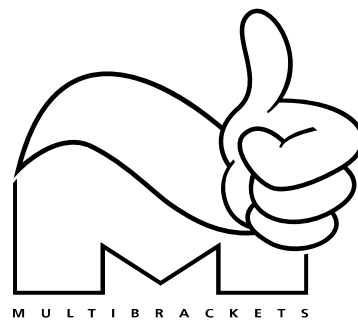



Официальный дистрибьютор компании Multibrackets

Россия: +7 495 640 75 57 | office@h-t.media
Беларусь: +375 29 383 6000 | belarus@h-t.media

www.h-t.media

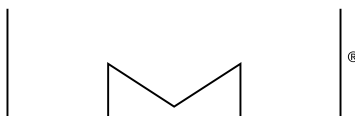

Multibrackets Europe AB

Phone: +46(0)8- 615 04 00 Mail: support@multibrackets.com

Postal address: Sveavägen 140 BV, SE-113 50 Stockholm, Sweden



Designed and
engineered in
Sweden