

IMPORTANT:
Go to www.extron.com for the complete user guide, installation instructions, and specifications before connecting the product to the power source.

CLASS 1 LASER PRODUCT, see *NAV E 511 User Guide* at www.extron.com.

⚠ WARNING: The NAV E 511 output continuous invisible light (Class 1 rated), which may be harmful to the eyes; use with caution.

- Do not look into the fiber optic cable connectors or into the fiber optic cables themselves.
- Plug the attached dust caps into the optical transceivers when the fiber cable is unplugged.

AVERTISSEMENT : Le NAV E 511 émettent une lumière invisible en continu (équipement de classe 1) qui peut être dangereuse pour les yeux ; à utiliser avec précaution.

- Ne pas fixer directement les connecteurs optiques ou les câbles fibre optique.
- Associez les bouchons anti-poussière à l'ensemble émetteur/récepteur optique lorsque le câble fibre optique est débranché.

This guide provides instructions for an experienced installer to install the Extron NAV E 511 streaming encoders and to make all connections. The Extron NAV encoder and one or more compatible decoders form an AV distribution and switching matrix on a managed 1G IP network.

NOTE: For more information on any subject in this guide, see the *NAV E 511 User Guide*, available at www.extron.com.

Installation

Step 1 – Mounting

Turn off or disconnect all equipment power sources and rack or furniture mount the encoder as required.

Step 2 – Rear Panel Connections

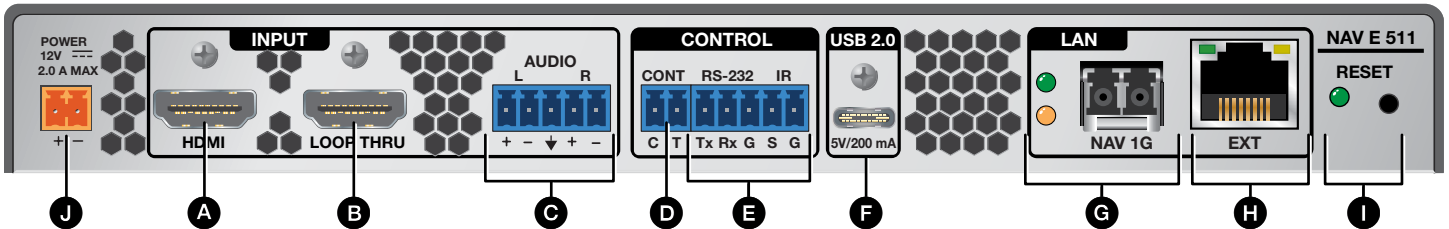

Figure 1. NAV E 511 Rear Panel Features

- A HDMI input port** — Connect an HDMI cable between this port and the HDMI output port (or DVI port, with an appropriate adapter) of the digital video source.
- B HDMI Loop Thru port** — Connect a display to this female HDMI connector for local loop-through monitoring of the source signal.

NOTE: See [LockIt® Lacing Brackets](#) on page 6 to securely fasten the HDMI connectors to the encoder for **A** and **B**.

- C Audio input port** — Connect balanced or unbalanced stereo audio input to this 5-pole, 3.5 mm captive screw connector (see [Analog audio input](#) on page 6 to wire the connector).
- D Control Contact Closure port** — Connect an Extron Show Me® cable to this port to allow the encoder to select itself as the input to the decoder, using the control system.
- E Control RS-232/IR port** — Connect a serial RS-232 signal, a modulated IR signal, or both to this 3.5 mm, 5-pole captive screw connector for bidirectional RS-232 and unidirectional IR communication with connected remote controlled devices using an Extron control system (see [Control connector](#) on page 6 to wire the connector).
- F USB 2.0 port** — Connect a USB Type-C cable from a USB host or a USB device. See [LockIt® Lacing Brackets](#) on page 6 to securely fasten the USB connector to the encoder.

NOTE: This connector is limited to supplying 200 mA in USB device mode.

- G NAV 1G port** (see [figure 1](#) on page 1) — Use a pair of fiber cables to connect to a LAN on which one or more decoders also reside for streaming and control.

NOTE: Ensure that you use the proper fiber cable for your encoder. Typically, singlemode fiber has a yellow jacket and multimode cable has an orange or aqua jacket.

- H Extension port** — If desired, connect another networked device to this port. The port acts as a networked 1G switch to the NAV 1G port (see [EXT connector](#) on page 6 to wire the connector).
- I Reset button and LED** — This button initiates three modes of reset (see the *NAV E 511 User Guide*, available at www.extron.com, for details).
- J Power connector** — Plug the included external 12 VDC power supply into this 2-pole connector (see [Power connector](#) on page 6 to wire the connector).

Step 3 – Front Panel Configuration Port Connection

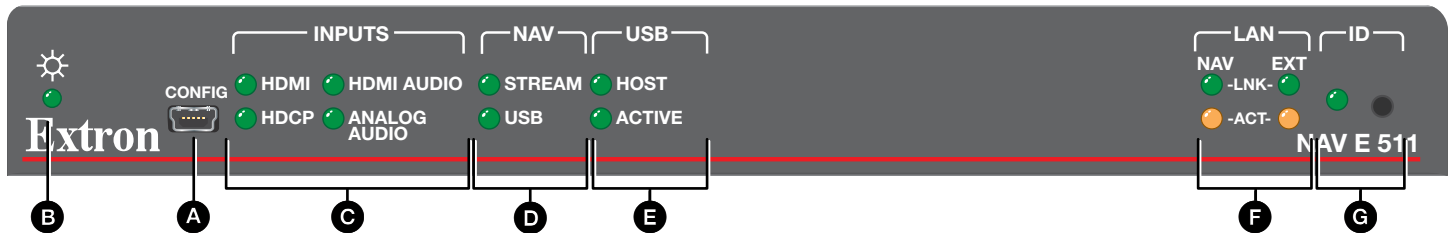

Figure 2. NAV E 511 Front Panel Features

- A Configuration port** — Connect a PC to the encoder via this front panel USB mini-B connector for configuration of the unit. The port uses IP over USB technology; the IP address is always 203.0.113.22 and **CANNOT** be changed. The Config port is also discoverable via Toolbelt (see the *NAV E 511 User Guide*). The guide and Toolbelt are available for download at www.extron.com).

Indicators

- B Power LED** — Indicates power and startup status.
 - Blinking** — The unit is receiving power and is booting up.
 - Lit steadily** — The unit is receiving power and is operational.
- C Input LEDs** — Indicates status of the signal inputs.
 - HDMI LED** — The encoder is detecting an HDMI input.
 - HDCP LED** — The HDMI signal is HDCP encrypted.
 - HDMI Audio LED** — The embedded HDMI audio input is selected.
 - Analog Audio LED** — The analog audio input is selected.
- D NAV LEDs** — Indicate the output status of the A/V and USB streams, as follows:
 - Stream**
 - Lit steadily** — The encoder is actively streaming a NAV output consisting of video, audio, or both.
 - Blinking** — The encoder is actively streaming a NAV output, but network errors are present.
 - Unlit** — The encoder is not actively streaming a NAV output consisting of video, audio, or both.
 - USB**
 - Lit steadily** — The encoder is actively sending and receiving a NAV USB stream.
 - Blinking** — The encoder is unable to establish a NAV USB stream.
 - Unlit** — The encoder is not actively sending and receiving a NAV USB stream.

NAV E 511 • Setup Guide (Continued)

E USB LEDs (see [figure 2](#) on page 2 — Indicates the status of the USB stream, as follows:

- **Host**
 - **Lit steadily** – The encoder is in USB host mode, the default condition.
 - **Unlit** – The encoder is in USB device mode.
- **Active**
 - **Lit steadily** – A host or USB device is connected to the rear panel USB port.
 - **Unlit** – No host or USB device is connected to the rear panel USB port.
 - **Blinking** – A USB device or hub is connected to the encoder and is drawing more power than the USB port can supply.

F LAN LEDs — Indicates status of the network connection.

- **NAV LED** —
 - **Link LED** — Lit steadily indicates that a network link is established at 1G.
 - **Act LED** — Blinking indicates network traffic. The blink rate corresponds to activity.
- **Ext LED** —
 - **Link LED** — Lit steadily indicates that a network link is established at 1G. Blinking indicates a link speed less than 1Gbps.
 - **Act LED** — Blinking indicates network traffic. The blink rate corresponds to activity.

G ID button and LED — The recessed ID button identifies the encoder to the NAVigator and decoder when pressed. The LED blinks when the encoder is in pairing mode (see [Pairing devices via front panel](#) on page 5 for details).

Operation

Power

When power is applied, the encoder runs a series of self-tests that blink the front panel Power LED and all other indicators. The encoder then boots the NAV operating system. It can take approximately 45 seconds for self-test and system startup to complete. When the process is complete, the Power LED lights steadily.

NOTE: The encoder is **NOT** operational until the boot process is complete (the Power LED is lit steadily).

System Operation

The encoder can be configured and controlled using embedded web pages or Extron Toolbelt (see the *NAV E 511 User Guide* available at www.extron.com and the Toolbelt Help file).

NOTE: The “Connection via web pages,” [Connection settings](#), and [Pairing devices via front panel](#) procedures (see page 5) may **NOT** be necessary if your system includes a NAVigator System Manager.

Connection via web pages

Connection to the encoder and its embedded web pages can be made via either the front panel Configuration (USB) port (using IP over USB technology) (see [figure 2](#), **A** on page 2) or the rear panel NAV 1G port (see [figure 1](#), **F** on page 1).

Access the encoder using HTML pages as follows:

1. Start a web browser.

NOTES:

- Suggested browsers to fully support the NAV system are: Google Chrome™, Mozilla™ Firefox™, and Microsoft® Edge™.
- The network must be properly configured for multicasting (IGMP). Failure to do so may result in degraded performance.

2. Enter the IP address of the encoder in the browser **Address** field.

NOTES:

- **Default settings:**

Port	DHCP	IP address	Subnet mask
Config (USB)*		203.0.113.22	
NAV 1G (Fiber)†	On		

- If you use IP over USB, Extron recommends waiting a minute after plugging in the cable for your PC to identify the USB connection as a valid Ethernet port.

* **For the Config port**, the address for IP over USB **CANNOT** be changed.

† **If the unit does not receive a DHCP address**, a self-assigned Link Local Address, is assigned in the range 169.254.X.X.

3. Press the keyboard **<Enter>** key. The browser displays a privacy error message (see [figure 3](#) at right for an example in the Chrome browser).
4. Click **Advanced** (see [figure 3](#), **1**). The button changes to **Hide Advanced** and explanatory text and a link appear below the button.
5. Click **Proceed to <IP address> (unsafe)** (**2**). The browser opens to the Login dialog box (see [figure 4](#)).



Figure 4. Login Dialog Box

6. Enter the **Username** (see [figure 4](#), **1**) and **Password** (**2**) and click **Sign In** (**3**). The browser opens to the embedded web pages (see [figure 5](#)).

NOTES:

- The default Username is admin.
- The factory configured passwords for all accounts on this device have been set to the device serial number. If the password is reset, the encoder reverts to the default password, which is extron.
- Usernames and passwords are case sensitive.

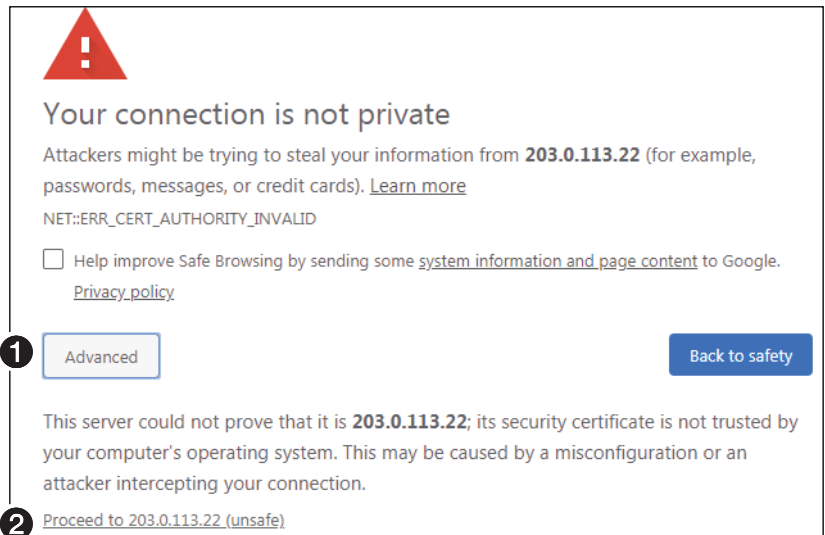

Figure 3. Privacy Error Message (in Chrome Browser)

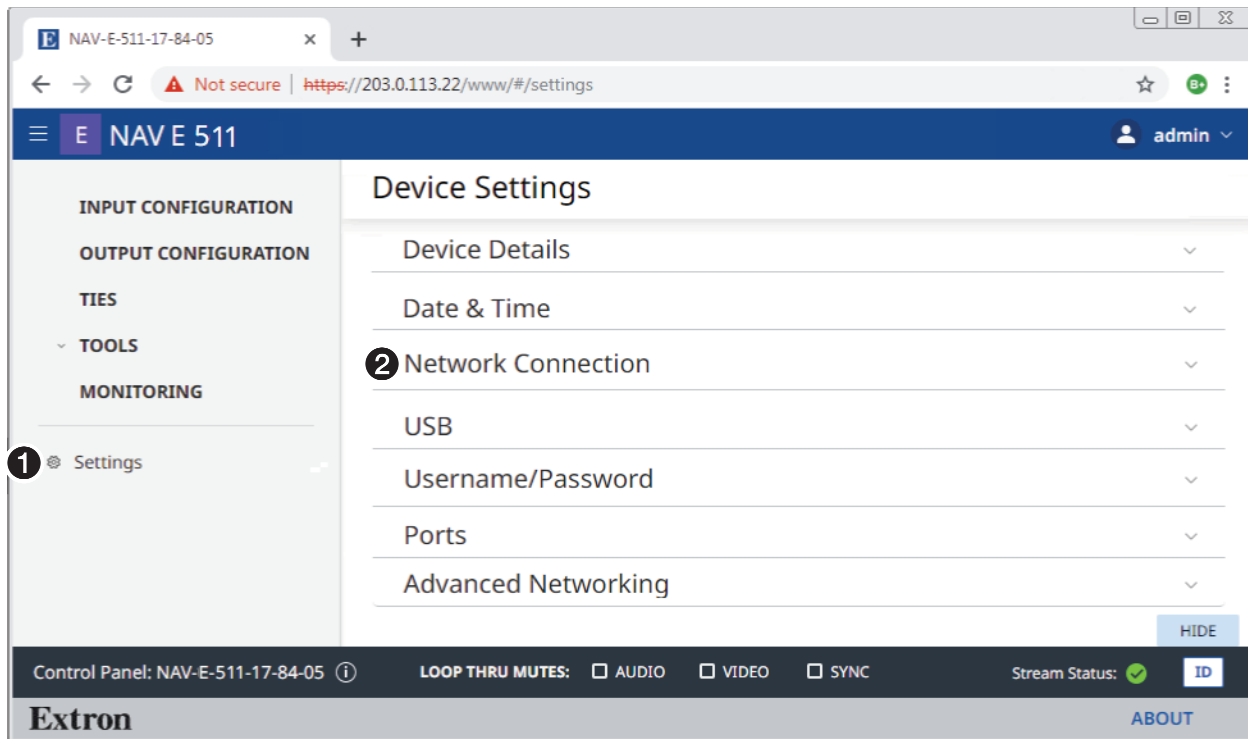

Figure 5. HTML Page

NOTE: Detailed descriptions of communication, configuration, and monitoring are provided in the *NAV E 511 User Guide*, available at www.extron.com.

Connection settings

View and change connection settings as follows:

1. On the home page, click **Settings** (see figure 5, ①) and then **Network Connection** (②). The Network Connection pane opens (see figure 6), showing protected views of the network connection settings.

NOTE: Editing of connection settings is disabled when the device is assigned to an Extron NAVigator System Manager.

2. To change the settings, click **Edit** (see figure 6, ①). The Edit button changes to **Save**.
3. Click in the desired field (②) and edit it as necessary.
4. Repeat step 3 as necessary for other values.
5. Click **Save**.

Pairing devices via front panel

Pair devices as follows:

1. Use a Tweezer or other small screwdriver to press and **hold** the **encoder** front panel **ID** button for approximately 3 seconds, until the ID LED blinks. The encoder enters pairing mode, which allows decoders to receive the AV and USB streams from encoders.
2. One at a time, use a Tweezer or other small screwdriver to press and **hold** the **decoder** front panel **ID** button for approximately 3 seconds, until the ID LED blinks three times. The decoder is now paired to the encoder.
3. Repeat step 2 for each decoder.

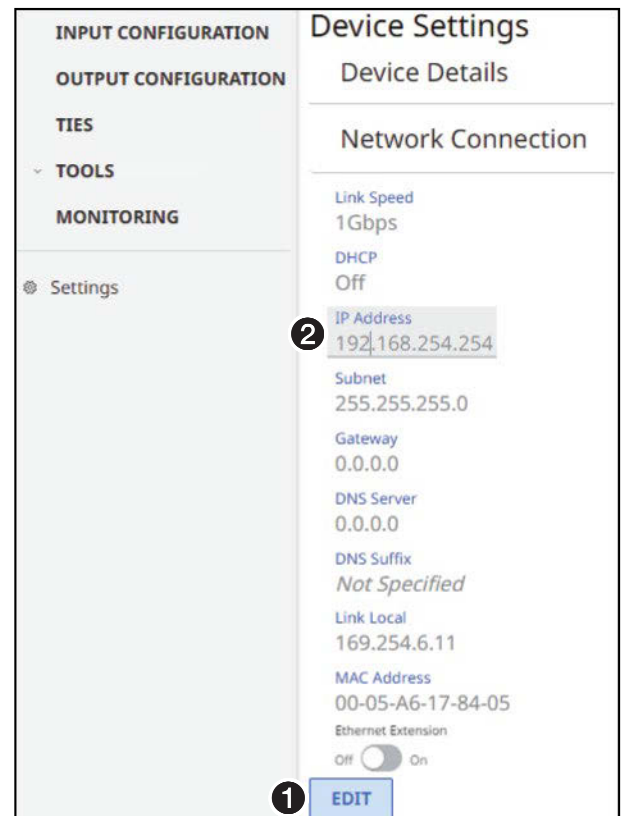

Figure 6. Network Connection Pane

- Use a Tweezer or other small screwdriver to press and release the encoder front panel **ID** button. The encoder exits pairing mode.
 - Repeat steps 1 through 4 to pair decoders to other encoders.
- After all devices are connected, powered on, and paired, the system is fully operational.

Operation in a System with a NAVigator

The Extron NAVigator is a system manager that easily configures and controls the NAV System. The NAVigator supports 16 endpoints by default, but a LinkLicense can upgrade its capabilities to support up to 240 endpoints.

See the *NAVigator User Guide*, available at www.extron.com for details.

Connection Details

LockIt® Lacing Brackets

- Plug the HDMI or USB cable into the panel connection (see ❶, at right for an HDMI example).
- Loosen the connection mounting screw from the panel enough to allow the LockIt lacing bracket to be placed over it (❷). The screw does not have to be removed.
- Place the LockIt lacing bracket on the screw and against the connector (❸), then tighten the screw to secure the bracket.

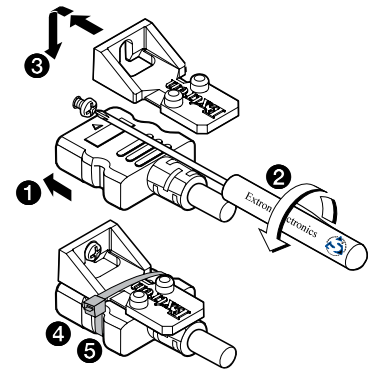

ATTENTION:

- Do not overtighten the connector mounting screw. The shield it fastens to is very thin and can easily be stripped.
- Ne serrez pas trop la vis de montage du connecteur. Le blindage auquel elle est attachée est très fin et peut facilement être dénudé.

- Loosely place the included tie wrap around the connector and the LockIt lacing bracket as shown (❹).
- While holding the connector securely against the lacing bracket, use pliers to tighten the tie wrap, then remove any excess length (❺).

Analog audio input

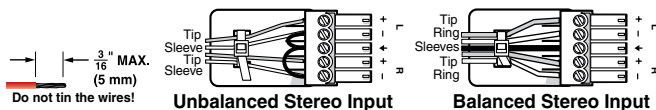

EXT connector

Pin	TIA/EIA T568B Wire color
1	White-orange
2	Orange
3	White-green
4	Blue
5	White-blue
6	Green
7	White-brown
8	Brown

TP Wires

Control connector

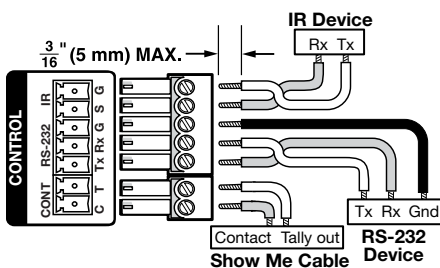

Power connector

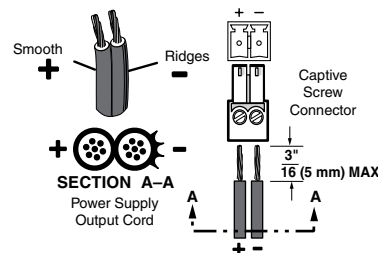

For information on safety guidelines, regulatory compliances, EMI/EMF compatibility, accessibility, and related topics, see the [Extron Safety and Regulatory Compliance Guide](#) on the Extron website.